

# D3\_HISUI-5R LOGIC SCHEMATICS (NV)

- 1: TITLE PAGE
- 2: EC HISTORY
- 3: CPU (1/3)
- 4: CPU (2/3)
- 5: CPU (3/3)
- 6: ITP CON/LARGE PTH HOLE/EMI FINGER
- 7: CRESTLINE (1/7) : HOST I/F
- 8: CRESTLINE (2/7) : DDR2-A
- 9: CRESTLINE (3/7) : DDR2-B
- 10: CRESTLINE (4/7) : PEG/DMI
- 11: CRESTLINE (5/7) : GRAPHICS
- 12: CRESTLINE (6/7) : VCC
- 13: CRESTLINE (7/7) : GND
- 14: POWER FOR CRESTLINE
- 15: DDR2 SODIMM-A
- 16: DDR2 SODIMM-B
- 17: DDR2 TERMINATION
- 18: DDR2 DECOUPLING
- 19: CLOCK GEN(ICS954309)
- 20: NV NB8P-GL (1/6) : PEG I/F
- 21: NV NB8P-GL (2/6) : LVDS/CRT/TV/TMDS
- 22: NV NB8P-GL (3/6) : VRAM I/F
- 23: NV NB8P-GL (4/6) : CLK/GPIO
- 24: NV NB8P-GL (5/6) : VCC
- 25: NV NB8P-GL (6/6) : GND
- 26: DYNAMIC MEMORY TERMINATION
- 27: VRAM FOR ATI M6X CHANNEL-A
- 28: LCD CONNECTOR
- 29: EXT CRT INTERFACE
- 30: PATA I/F PU
- 31: ICH8-M (1/4) : DMI/PCI/LPC/AC97
- 32: ICH8-M (2/4) : ATA/USB/PM
- 33: ICH8-M (3/4) : PCI EXPRESS
- 34: ICH8-M (4/4) : VCC/GND
- 35: FWH, RTC BATTERY
- 36: SATA HDD CONN
- 37: BAY I/F CONN
- 38: USB POWER/CONN
- 39: AUDIO AD1981HD
- 40: AUDIO MISC
- 41: AUDIO INT MIC
- 42: AUDIO HP & EXT MIC CONN
- 43: AUDIO EXT MIC AMP
- 44: AUDIO SPEAKER
- 45: AUDIO HDP AMP MAX9789A(1/2)
- 46: AUDIO HDP AMP MISC(2/2)

- 47: CDC CONNECTOR
- 48: CARDBUS CONTROLLER(1/2)
- 49: CARDBUS CONTROLLER(2/2)
- 50: CARDBUS/EXC SLOT
- 51: CARDBUS/EXC PWR CTRL
- 52: GBE LAN SW
- 53: GBE NINEVEH(1/2)
- 54: MICRO PCIE CONN
- 55: GBE MAGNETICS
- 56: RJ11/RJ45 CONNECTOR
- 57: MINI PCI SLOT
- 58: EEPROM/FLASH/SHARED
- 59: DOCKING CONNECTOR
- 60: H8S/2116B (1/2)
- 61: H8S/2116B (2/2)
- 62: KEYBOARD CONNECTOR
- 63: TOUCH PAD CONNECTOR
- 64: MISC G/A (PMH7)
- 65: SUPER I/O (PC87385)
- 66: WIRELESS DISABLE SW
- 67: LEGACY IO INTERFACE
- 68: BLANK PAGE
- 69: THERMAL SENSOR
- 70: I2CBUS/SMBUS
- 71: FAN CONTROL
- 72: G-SENSOR
- 73: EMC DECOUPLING
- 74: RGB SWITCH
- 75: DC-IN
- 76: BATTERY CHARGER (MAX8765)
- 77: CHARGE SELECTOR
- 78: BATTERY INPUT
- 79: BATTERY MONITOR
- 80: POWER SEQUENCE
- 81: DC-DC VCC3M/VCC5M (MAX17003)
- 82: DC-DC VCCCPUCORE (ADP3207)
- 83: VCCCPUCORE DECOUPLING
- 84: DC-DC VCC1R05M
- 85: DC-DC VCCGFXCORE (ADP3209)
- 86: DC-DC VCC1R8M/VCC0R9A (MAX8632)
- 87: DC-DC VCC1R05M/VCC1R5M (MAX1540)
- 88: DC-DC VCC1R25AMT (VT321)
- 89: LOAD SW AMT/LAN
- 90: CLPWRG
- 91: RINKAN-1 VIDEO
- 92: LOAD SW VIDEO
- 93: LOAD SW A&AUX
- 94: LOAD SW B&UBAY
- 95: MAX POWER CTRL

- 96: POWER MOMITOR
- 97: PTH FOR SCREW HOLES
- 98: LOAD SW VCC3KDDI

BASE LOGIC:H4R  
MAR/23/2007  
VER 4.10

APR/10/2007  
VER 5.02

REL	DATE	EC NO.	PART NO.
	04/10/07	L11434	42W9341
			DEVELOPMENT NO.
			1 / 98

DESIGNER	K.Y	04/10/07	PART NO.
CHECKED	Y.Y	04/10/07	42W9341
APPROVED	H.K	04/10/07	TITLE DAV3_HISUI5_R
CLASS			TITLE PAGE

42W9341

http://shop36609371.taobao.com 52643956

A	B	C	D	E	F	G	H	J	K	L	M	N	P	Q
<b>EC HISTORY</b>														
DAVINCI-3 (BASE LOGIC MAGI-7 VER.6.01)														
SDV (BASE LOGIC D3PDV VER.0.39)														
FVT (BASE LOGIC D3SDV VER.1.14)														
SIV_WIDE (BASE LOGIC D3FVT VER.2.11)														
SUZAKU3_W (BASE LOGIC SIV_WIDE VER.3.09)														
SUZAKU3_R (BASE LOGIC SUZAKU3_W VER.3.24)														
SUZAKU4_R (BASE LOGIC SUZAKU3_R VER.3.54)														
SUZAKU4_R(NV) (BASE LOGIC SUZAKU4_R VER.4.01)														
HISUI_2R(NV) (BASE LOGIC HISUI_1W(NV) VER.1.04)														
VER.2.00 11/13/2006 APPLIED DAV3_W2R 001-003,005,007,008														
DAV3_SIV 118,DAV3_SIT 025,035,038														
DAV3_SIT 041-043,047.048,058-064,069,071-075,077,079-082														
084-086,088-092,095,096,099,100,102														
VER.2.01 11/15/2006 APPLIED DAV3_SIT 104-107														
VER.2.02 11/16/2006 APPLIED DAV3_NV 069,071,072,075,076														
VER.2.03 11/20/2006 CANCELED SIT_EC075 APPLIED DAV3_SIT 110-112,115														
VER.2.04 11/21/2006 APPLIED DAV3_SIT 116,118,119-123														
VER.2.05 11/24/2006 APPLIED DAV3_SIT 126,127,128														
VER.2.06 11/27/2006 APPLIED DAV3_NV_080														
VER.2.07 11/28/2006 APPLIED DAV3_NV_081 DAV3_SIT 131,132														
CORRECTED DAV3_SIT 118														
VER.2.08 11/29/2006 APPLIED DAV3_SIT_139 DAV3_NV_082														
VER.2.09 11/30/2006 APPLIED DAV3_SIT_141														
VER.2.10 12/04/2006 APPLIED DAV3_SIT_145,146,148-150														
VER.2.11 12/07/2006 APPLIED DAV3_SIT_153,155														
VER.2.12 12/08/2006 APPLIED DAV3_SIT_156 DAV3_NV_085														
VER.2.13 12/12/2006 APPLIED DAV3_SIT_157,159														
VER.2.14 12/14/2006 APPLIED DAV3_NV_086														
VER.2.15 12/15/2006 APPLIED DAV3_SIT_162-164														
VER.2.16 12/18/2006 APPLIED DAV3_SIT_166														
VER.2.17 12/22/2006 APPLIED DAV3_NV_090														
VER.2.18 12/27/2006 APPLIED DAV3_NV_094														
VER.2.19 12/28/2006 APPLIED DAV3_SIT_177														

HISUI_3R(NV) (BASE LOGIC HISUI_2R(NV) VER.2.19)														
VER.3.50 01/15/2007 APPLIED DAV3_SIT_172,173,176,178,181,182														
DAV3_NV_091,093 DAV3_SVT_001														
VER.3.51 01/17/2007 APPLIED DAV3_SIT_183, SVT_005,006,009														
VER.3.52 01/19/2007 APPLIED DAV3_SVT_011														
VER.3.53 01/22/2007 APPLIED DAV3_SVT_014,016														
VER.3.54 01/23/2007 APPLIED DAV3_SVT_017,020														
VER.3.55 01/24/2007 APPLIED DAV3_SVT_022														
VER.3.56 01/25/2007 APPLIED DAV3_SIT_184, SVT_024														
VER.3.57 01/26/2007 APPLIED DAV3_SVT_026														
VER.3.58 01/29/2007 APPLIED DAV3_SVT_027-030														
VER.3.59 01/30/2007 APPLIED DAV3_SVT_032														
VER.3.60 01/31/2007 APPLIED DAV3_SVT_033,035														

HISUI_4R(NV) (BASE LOGIC HISUI_3R(NV) VER.3.60)														
VER.4.00 02/06/2007 APPLIED DAV3_SVT_023,038,039														
VER.4.01 02/08/2007 APPLIED DAV3_SVT_042-044														
VER.4.02 02/13/2007 APPLIED DAV3_SVT_046														
VER.4.03 02/26/2007 APPLIED DAV3_SVT_061														
VER.4.04 02/27/2007 APPLIED DAV3_SVT_052,053,056														
VER.4.05 02/28/2007 APPLIED DAV3_SVT_062														
VER.4.06 03/02/2007 APPLIED DAV3_SVT_064,066-068														
VER.4.07 03/06/2007 APPLIED DAV3_SVT_069														
VER.4.08 03/09/2007 APPLIED DAV3_SVT_071,072														
VER.4.09 03/19/2007 APPLIED DAV3_SOP_004-007,009														
VER.4.10 03/23/2007 APPLIED DAV3_SOP_003,012,013														

HISUI_5R(NV) (BASE LOGIC HISUI_4R(NV) VER.4.10)														
VER.5.00 03/30/2007 APPLIED DAV3_SOP_011,014,015														
VER.5.01 04/09/2007 APPLIED DAV3_SOP_017														
VER.5.02 04/10/2007 APPLIED DAV3_SOP_020														

DESIGNER	K.Y	04/10/07	PART NO.	42W9341
CHECKED	Y.Y	04/10/07	TITLE	DAV3_HISUI5_R
APPROVED	H.K	04/10/07	HISTORY	
CLASS				
THIS DOCUMENT IS THE PROPERTY OF LENOVO. IT IS LOANED TO YOU FOR USE ONLY. IT IS NOT TO BE REPRODUCED OR TRANSMITTED IN ANY FORM OR BY ANY MEANS, ELECTRONIC OR MECHANICAL, INCLUDING PHOTOCOPYING, RECORDING, OR BY ANY INFORMATION STORAGE AND RETRIEVAL SYSTEM. FOR MORE INFORMATION, CONTACT THE LENOVO PURCHASING DEPARTMENT.				

http://shop36609371.taobao.com 笔记本维修资料

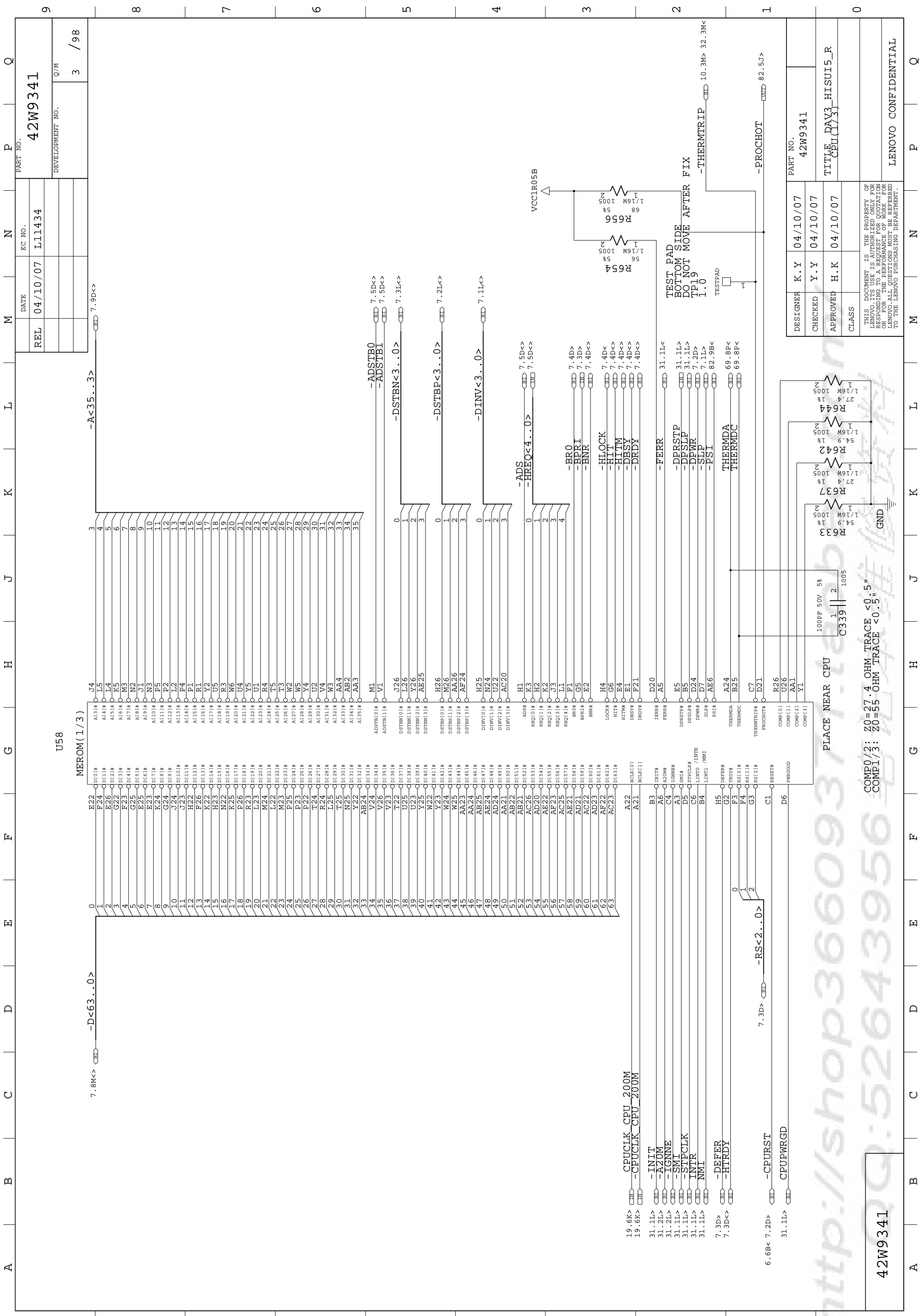

42W9341

COMPO/2: Z0=27.4 OHM TRACE <0.5" <br> COMPL/3: Z0=55 OHM TRACE <0.5" <br> PLACE NEAR CPU

100PF 50V 5% <br> C339

RESISTORS: R637, R642, R644, R654, R655

TEST PAD BOTTOM SIDE DO NOT MOVE AFTER FIX

VCC1R05B

THERMTRIP

PROCHOT

DESIGNER	K.Y	04/10/07	PART NO.	42W9341
CHECKED	Y.Y	04/10/07	TITLE	TITLE_DAV3_HISUI5_R CPU(1/3)
APPROVED	H.K	04/10/07	CLASS	LENOVO CONFIDENTIAL

THIS DOCUMENT IS THE PROPERTY OF IBM. IT IS TO BE USED FOR THE PURPOSES SPECIFIED IN THE TITLE. NO PART OF THIS DOCUMENT IS TO BE REPRODUCED OR TRANSMITTED IN ANY FORM OR BY ANY MEANS, ELECTRONIC OR MECHANICAL, INCLUDING PHOTOCOPYING, RECORDING, OR BY ANY INFORMATION STORAGE AND RETRIEVAL SYSTEM. FOR MORE INFORMATION, CONTACT THE IBM CORPORATION, 505 NORTH ZEEB ROAD, ARMONK, NY 10504-1700, U.S.A. OR YOUR LOCAL IBM OFFICE. IBM AND THE IBM LOGO ARE TRADEMARKS OF INTERNATIONAL BUSINESS MACHINES CORPORATION. ALL OTHER TRADEMARKS ARE THE PROPERTY OF THEIR RESPECTIVE OWNERS.

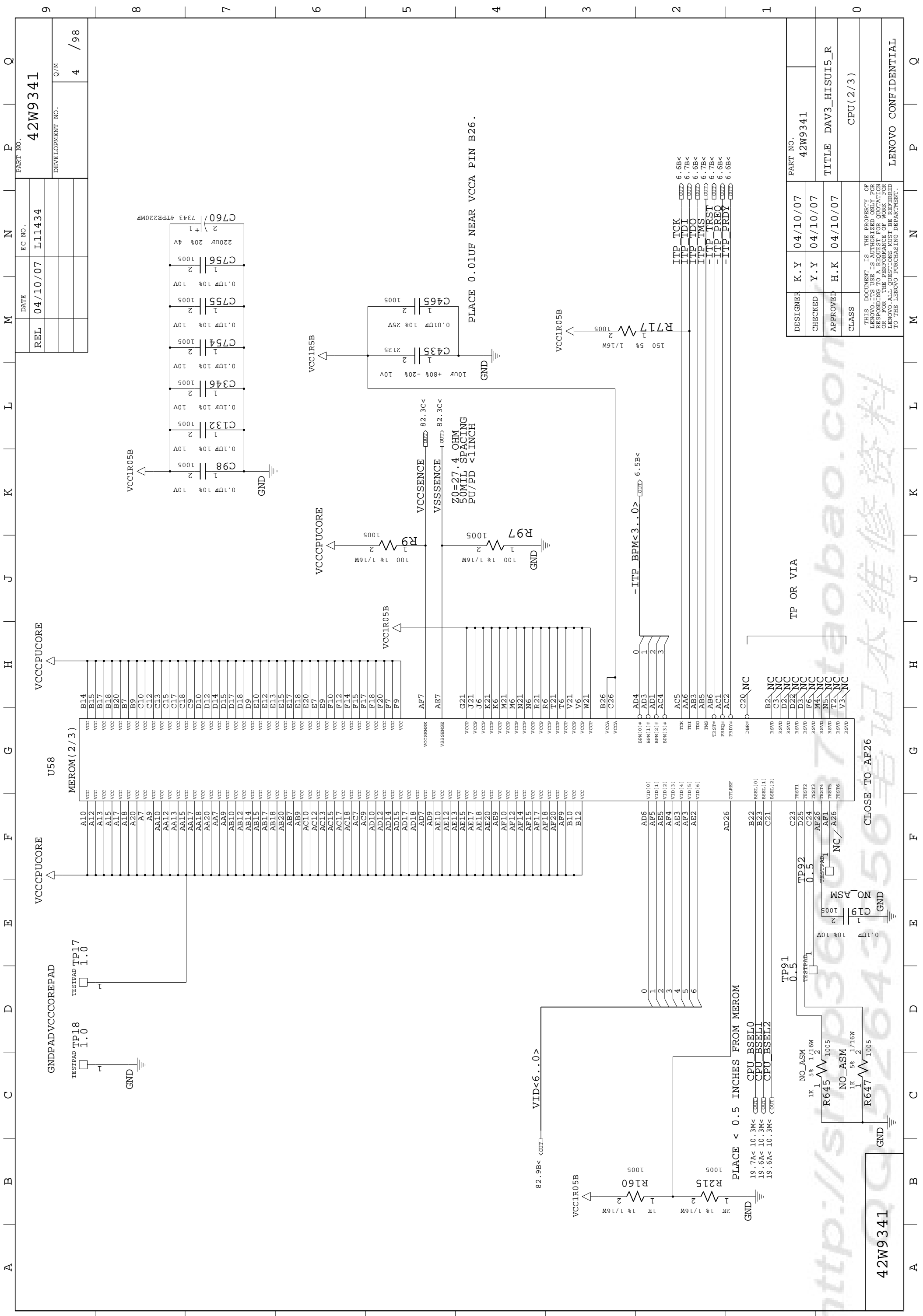

REL	DATE	EC NO.	PART NO.
	04/10/07	L11434	42W9341
			DEVELOPMENT NO.
			Q/M
			4 / 98

DESIGNER	K.Y	04/10/07	PART NO.
CHECKED	Y.Y	04/10/07	42W9341
APPROVED	H.K	04/10/07	TITLE
CLASS			DAV3_HISUI5_R
			CPU(2/3)

THIS DOCUMENT IS THE PROPERTY OF  
LENOVO. IT IS LOANED TO YOU FOR  
YOUR USE ONLY. IT IS NOT TO BE  
REPRODUCED OR TRANSMITTED IN ANY  
FORM OR BY ANY MEANS, ELECTRONIC  
OR MECHANICAL, INCLUDING PHOTOCOPYING,  
RECORDING, OR BY ANY INFORMATION  
SYSTEMS. ALL QUESTIONS MUST BE REFERRED  
TO THE LENOVO PURCHASING DEPARTMENT.

42W9341

CLOSE TO AF26

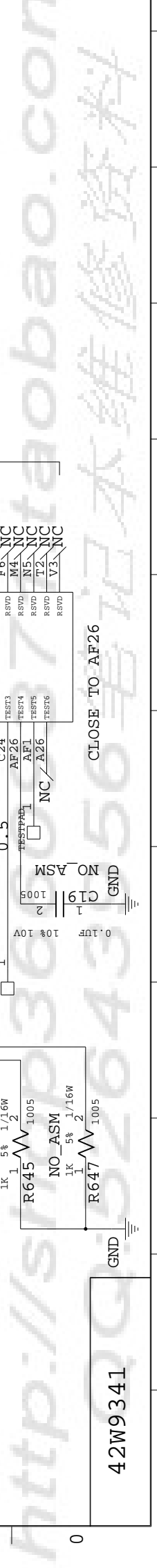

REL	04/10/07	L11434	42W9341
DATE	04/10/07	L11434	42W9341
EC NO.			
PART NO.			
DEVELOPMENT NO.		Q/M	
		5	/98

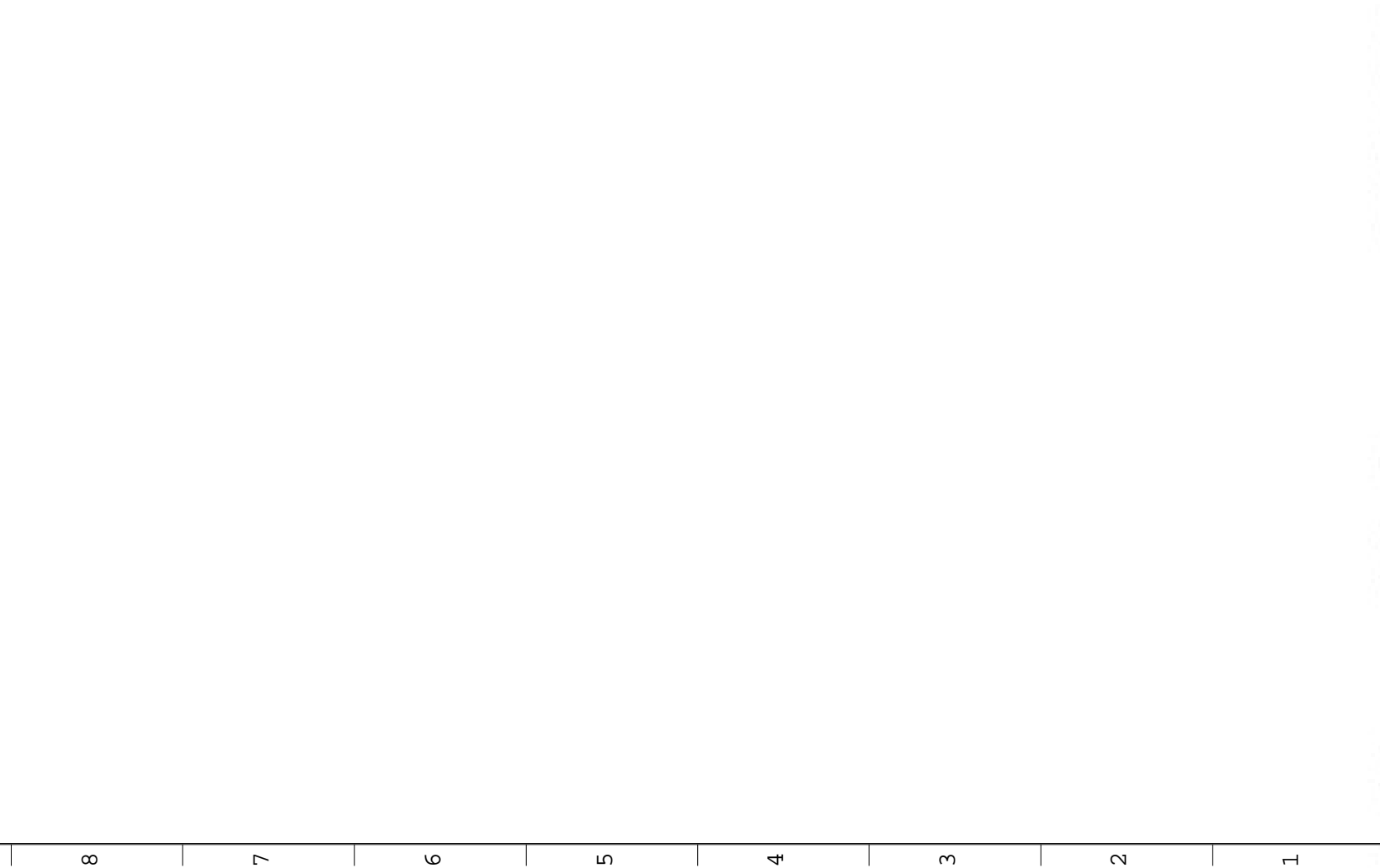
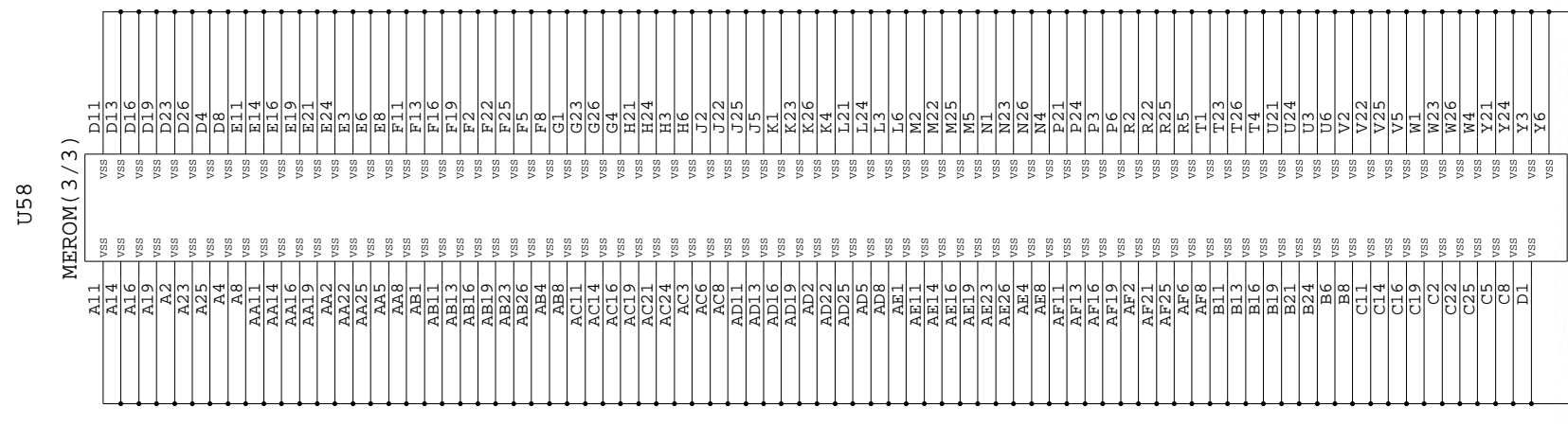

DESIGNER	K.Y	04/10/07	PART NO.	42W9341
CHECKED	Y.Y	04/10/07	TITLE	DAV3_HISUI5_R
APPROVED	H.K	04/10/07	CLASS	CPU(3/3)
THIS DOCUMENT IS THE PROPERTY OF LENOVO. IT IS LOANED TO YOU FOR USE ONLY. IT IS NOT TO BE REPRODUCED OR TRANSMITTED IN ANY FORM OR BY ANY MEANS, ELECTRONIC OR MECHANICAL, INCLUDING PHOTOCOPYING, RECORDING, OR BY ANY INFORMATION STORAGE AND RETRIEVAL SYSTEM. ALL RIGHTS RESERVED. FOR MORE INFORMATION, CONTACT THE LENOVO PURCHASING DEPARTMENT.				

42W9341

http://shop36609371.taobao.com 笔记本维修资料

REL		DATE	EC NO.	PART NO.
04/10/07		L11434	42W9341	
				Q/M
				6 / 98

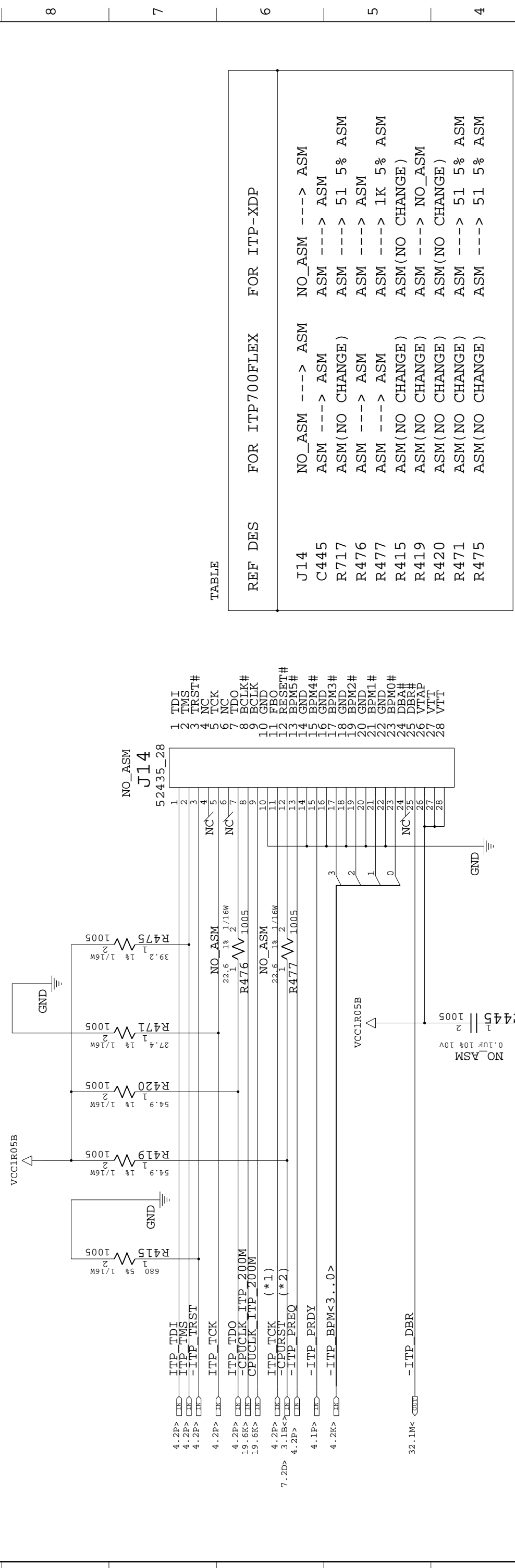

NOTE: C445,R476 AND R477 "ASM" BEFORE SIT, "NO\_ASM" FROM SIT.

- (\*1) TCK SIGNAL IS BRANCHED AT YONAH PIN
- (\*2) -CPURST SIGNAL IS BRANCHED AT CRESTLINE PIN

DESIGNER	K.Y	04/10/07	PART NO.	42W9341
CHECKED	Y.Y	04/10/07	TITLE	DAV3_HISUI5_R
APPROVED	H.K	04/10/07	ITP CONN/LARGE PTH HOLE	EMI FINGER
CLASS			LENOVO CONFIDENTIAL	

42W9341

http://shop36609371.taobao.com 笔记本维修资料



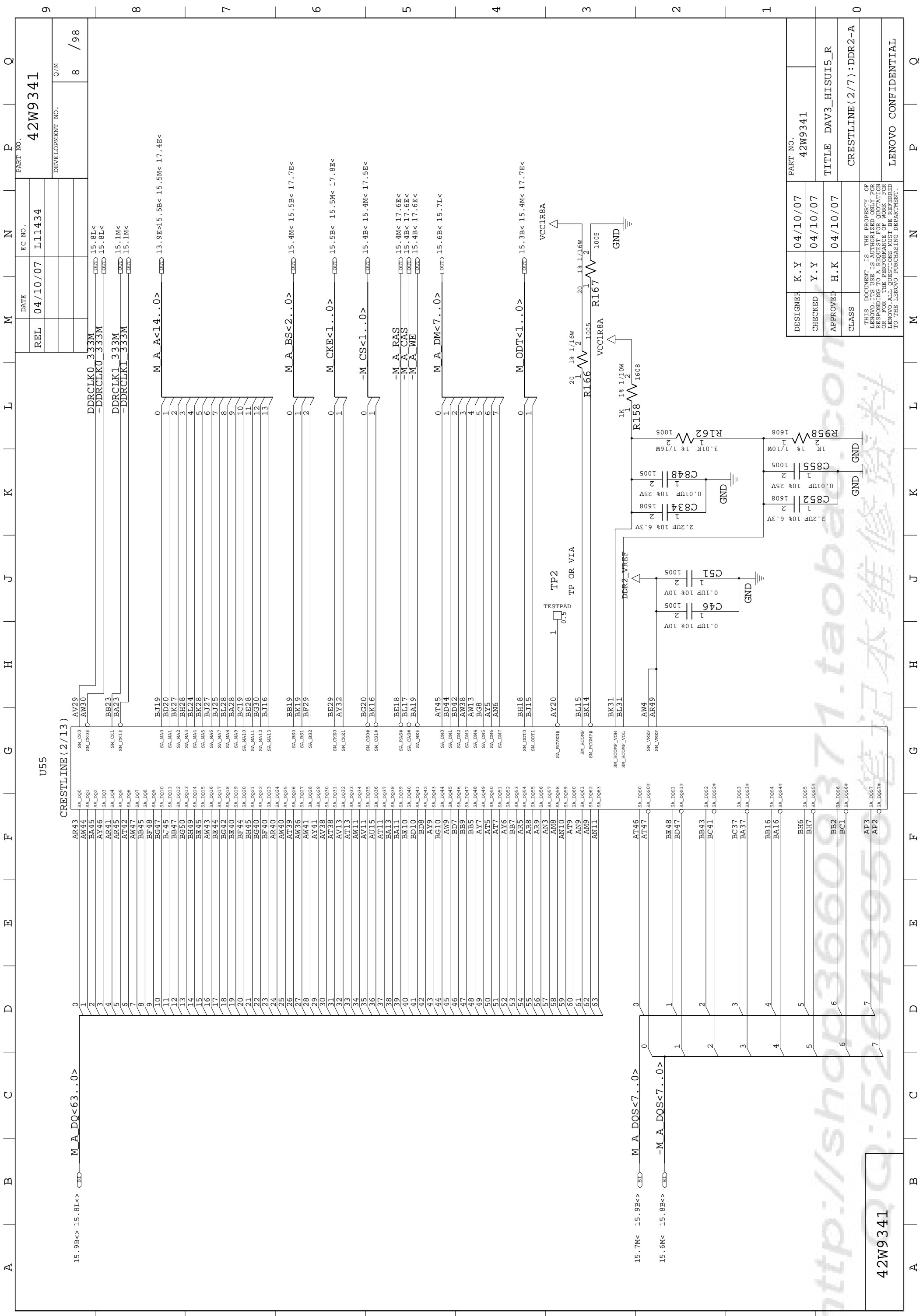

U55

CRESTLINE (2/13)

REL	04/10/07	L11434	EC NO.		PART NO.	42W9341
DEVELOPMENT NO.						8 / 98

DESIGNER	K.Y	04/10/07	PART NO.	42W9341
CHECKED	Y.Y	04/10/07	TITLE	DAV3_HISUI5_R
APPROVED	H.K	04/10/07	CRESTLINE(2/7)	DDR2-A
CLASS				

THIS DOCUMENT IS THE PROPERTY OF LENOVO. IT IS LOANED TO YOU FOR USE ONLY. IT IS NOT TO BE REPRODUCED OR TRANSMITTED IN ANY FORM OR BY ANY MEANS, ELECTRONIC OR MECHANICAL, INCLUDING PHOTOCOPYING, RECORDING, OR BY ANY INFORMATION STORAGE AND RETRIEVAL SYSTEM. ANY UNAUTHORIZED USE OF THIS DOCUMENT IS STRICTLY PROHIBITED. FOR MORE INFORMATION, CONTACT YOUR LENOVO PURCHASING DEPARTMENT.

42W9341



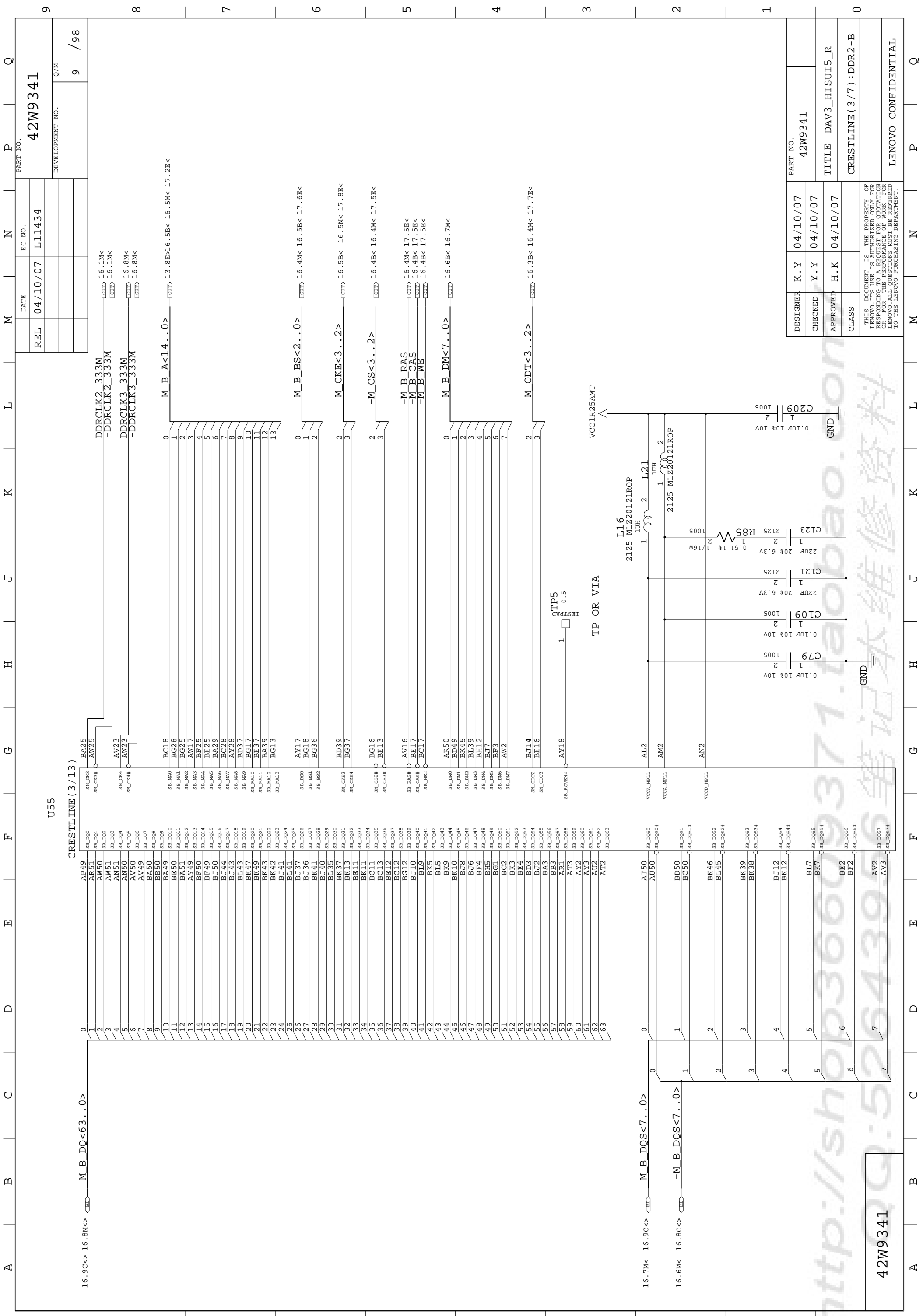

REL	DATE	EC NO.	PART NO.
04/10/07	04/10/07	L11434	42W9341
			DEVELOPMENT NO.
			9 / 98

U55

CRESTLINE (3/13)

AP49	SB_D00	BA25	
AR51	SB_D01	AW25	
AW50	SB_D02		DDRCLK2_333M
AW51	SB_D03		-DDRCLK2_333M
AN51	SB_D04		16.1M<
AN50	SB_D05		16.1M<
AV50	SB_D06		16.8M<
AV49	SB_D07		16.8M<
BA50	SB_D08		
BA50	SB_D09		
BA49	SB_D10		
BE50	SB_D11		
BA51	SB_D12		
AY49	SB_D13		
BF50	SB_D14		
BF49	SB_D15		
BJ50	SB_D16		
BJ44	SB_D17		
BJ43	SB_D18		
BL43	SB_D19		
BK47	SB_D20		
BK49	SB_D21		
BK43	SB_D22		
BK42	SB_D23		
BK41	SB_D24		
BL41	SB_D25		
BJ37	SB_D26		
BJ36	SB_D27		
BK41	SB_D28		
BJ40	SB_D29		
BL36	SB_D30		
BK37	SB_D31		
BK13	SB_D32		
BE11	SB_D33		
BK11	SB_D34		
BC11	SB_D35		
BC13	SB_D36		
BE12	SB_D37		
BC12	SB_D38		
BG12	SB_D39		
BJ10	SB_D40		
BL9	SB_D41		
BK5	SB_D42		
BL5	SB_D43		
BK9	SB_D44		
BK10	SB_D45		
BJ8	SB_D46		
BJ6	SB_D47		
BF4	SB_D48		
BH5	SB_D49		
BG1	SB_D50		
BC2	SB_D51		
BK3	SB_D52		
BE4	SB_D53		
BD3	SB_D54		
BJ2	SB_D55		
BA3	SB_D56		
BB3	SB_D57		
AR1	SB_D58		
AT3	SB_D59		
AV2	SB_D60		
AY2	SB_D61		
AU2	SB_D62		
AU2	SB_D63		
AT2	SB_D64		
AT50	SB_D65		
AU50	SB_D66		
BD50	SB_D67		
BC50	SB_D68		
BK46	SB_D69		
BL45	SB_D70		
BK39	SB_D71		
BK38	SB_D72		
BJ12	SB_D73		
BK12	SB_D74		
BL7	SB_D75		
BK7	SB_D76		
AV2	SB_D77		
AV3	SB_D78		

16.9C<< 16.8M<> M\_B\_DQ<63..0>

0 M\_B\_A<14..0>  
1 13.8E>16.5B< 16.5M< 17.2E<  
2  
3  
4  
5  
6  
7  
8  
9

0 M\_B\_BS<2..0>  
1 16.4M< 16.5B< 17.6E<  
2

2 M\_CKE<3..2>  
3 16.5B< 16.5M< 17.8E<

2 -M\_CS<3..2>  
3 16.4B< 16.4M< 17.5E<

-M\_B\_RAS  
-M\_B\_CAS  
-M\_B\_WE  
M\_B\_DM<7..0>  
0 16.6B< 16.7M<

2 M\_ODT<3..2>  
3 16.3B< 16.4M< 17.7E<

16.7M< 16.9C<> M\_B\_DQS<7..0>

16.6M< 16.8C<> -M\_B\_DQS<7..0>

DESIGNER	K.Y	04/10/07	PART NO.	42W9341
CHECKED	Y.Y	04/10/07	TITLE	DAV3_HISUI5_R
APPROVED	H.K	04/10/07	CRESTLINE (3/7)	DDR2-B
CLASS				

42W9341

THIS DOCUMENT IS THE PROPERTY OF LENOVO. IT IS LOANED TO YOU FOR USE ONLY. IT IS NOT TO BE REPRODUCED OR TRANSMITTED IN ANY FORM OR BY ANY MEANS, ELECTRONIC OR MECHANICAL, INCLUDING PHOTOCOPYING, RECORDING, OR BY ANY INFORMATION STORAGE AND RETRIEVAL SYSTEM. FOR MORE INFORMATION, CONTACT YOUR LENOVO ACCOUNT MANAGER OR THE LENOVO PURCHASING DEPARTMENT.



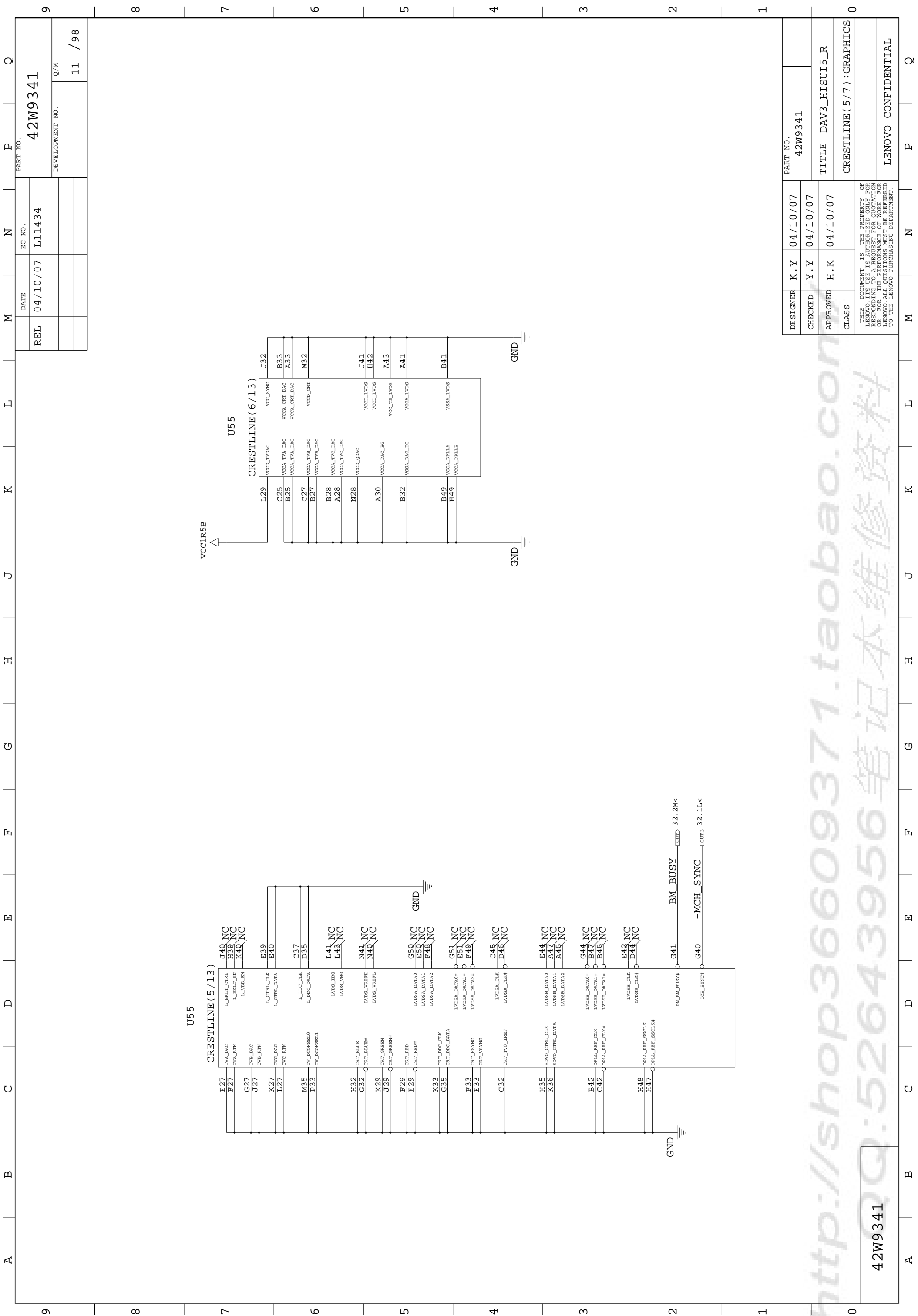

REL	DATE	EC NO.	PART NO.
	04/10/07	L11434	42W9341
			DEVELOPMENT NO.
			Q/M
			11 / 98

DESIGNER	K.Y	04/10/07	PART NO.	42W9341
CHECKED	Y.Y	04/10/07	TITLE	DAV3_HISUI5_R
APPROVED	H.K	04/10/07	CLASS	CRESTLINE(5/7):GRAPHICS
THIS DOCUMENT IS THE PROPERTY OF LENOVO. IT IS TO BE USED ONLY FOR THE PURPOSES SPECIFIED HEREIN. ANY REUSE OR DISTRIBUTION WITHOUT THE WRITTEN PERMISSION OF LENOVO PURCHASING DEPARTMENT IS STRICTLY PROHIBITED. FOR MORE INFORMATION, PLEASE CONTACT LENOVO PURCHASING DEPARTMENT.				
LENOVO CONFIDENTIAL				

http://shop36609371.taobao.com 笔记本维修资料

42W9341

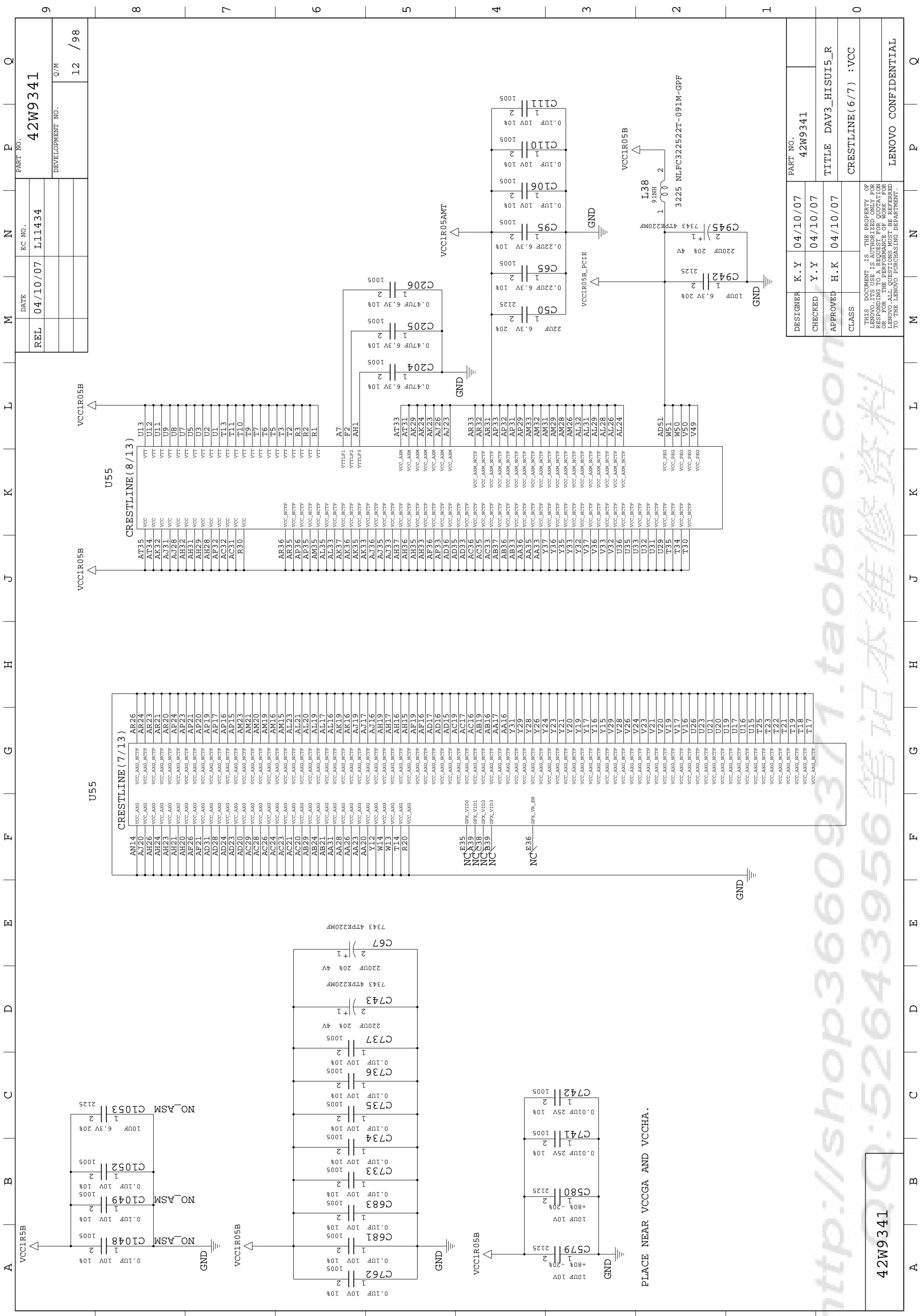

REL	DATE	EC NO.	PART NO.
	04/10/07	L11434	42W9341
			DEVELOPMENT NO.
			Q/M
			12 / 98

DESIGNER	K.Y	04/10/07	PART NO.	42W9341
CHECKED	Y.Y	04/10/07	TITLE	DAV3_HISUI5_R
APPROVED	H.K	04/10/07	CRESTLINE(6/7)	: VCC
CLASS				

42W9341

http://shop36609371.taobao.com 笔记本维修资料

THIS DOCUMENT IS THE PROPERTY OF  
LENOVO. IT IS LOANED TO YOU FOR  
YOUR USE ONLY. IT IS NOT TO BE  
REPRODUCED OR TRANSMITTED IN  
ANY FORM OR BY ANY MEANS, FOR  
OR FOR THE PERFORMANCE OF WORK  
LENOVO. ALL QUESTIONS MUST BE REFERRED  
TO THE LENOVO PURCHASING DEPARTMENT.

LENOVO CONFIDENTIAL



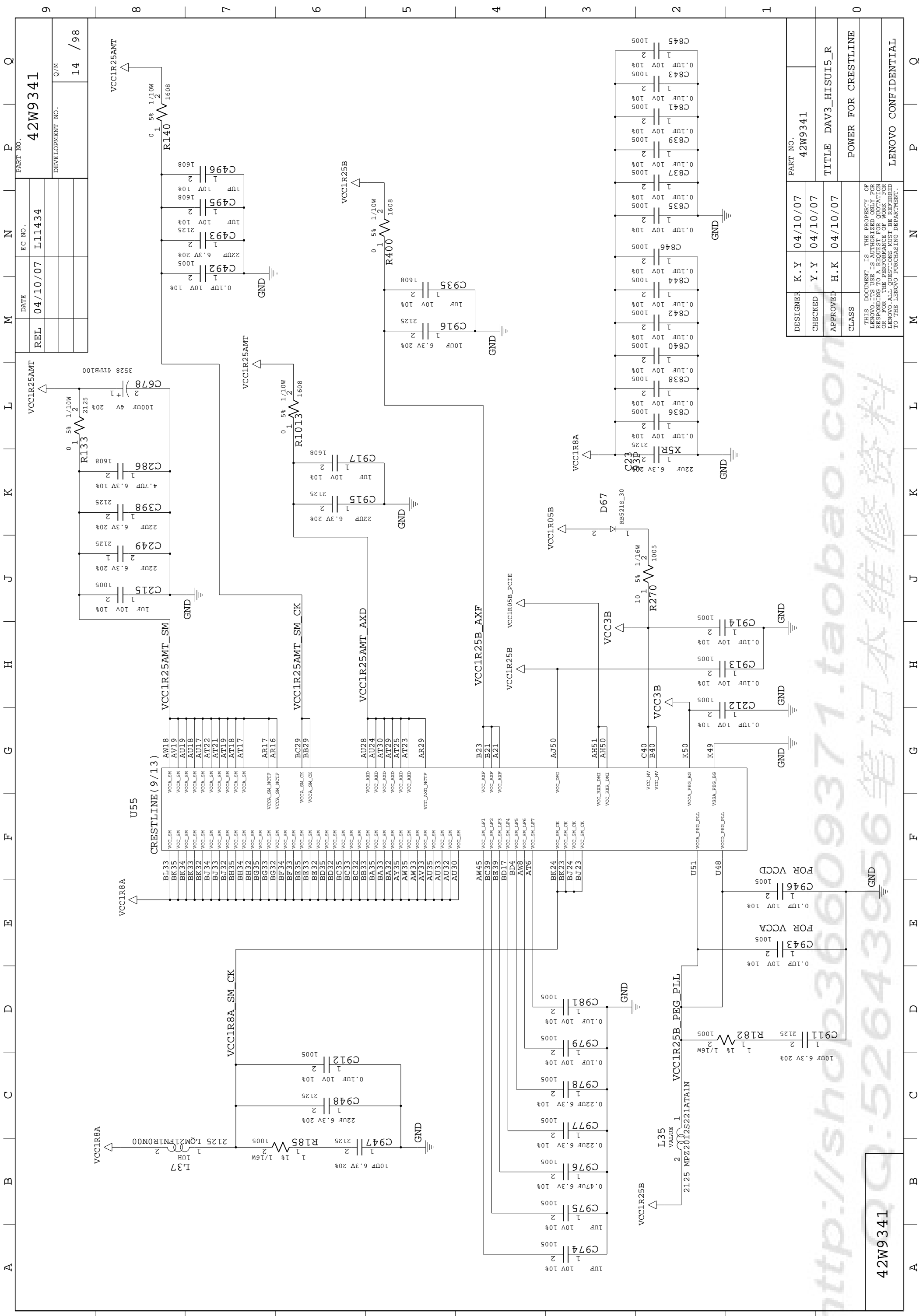

REL	DATE	EC NO.	PART NO.
	04/10/07	L11434	42W9341
			DEVELOPMENT NO.
			Q/M
			14 / 98

DESIGNER	K.Y	04/10/07	PART NO.	42W9341
CHECKED	Y.Y	04/10/07	TITLE	DAV3_HISUI5_R
APPROVED	H.K	04/10/07	POWER FOR CRESTLINE	
CLASS			LENOVO CONFIDENTIAL	

THIS DOCUMENT IS THE PROPERTY OF  
LENOVO. IT IS LOANED TO YOU FOR  
YOUR USE ONLY. IT IS NOT TO BE  
REPRODUCED OR TRANSMITTED IN  
ANY FORM OR BY ANY MEANS, FOR  
OR FOR THE PERFORMANCE OF WORK  
LENOVO. ALL QUESTIONS MUST BE REFERRED  
TO THE LENOVO PURCHASING DEPARTMENT.

42W9341



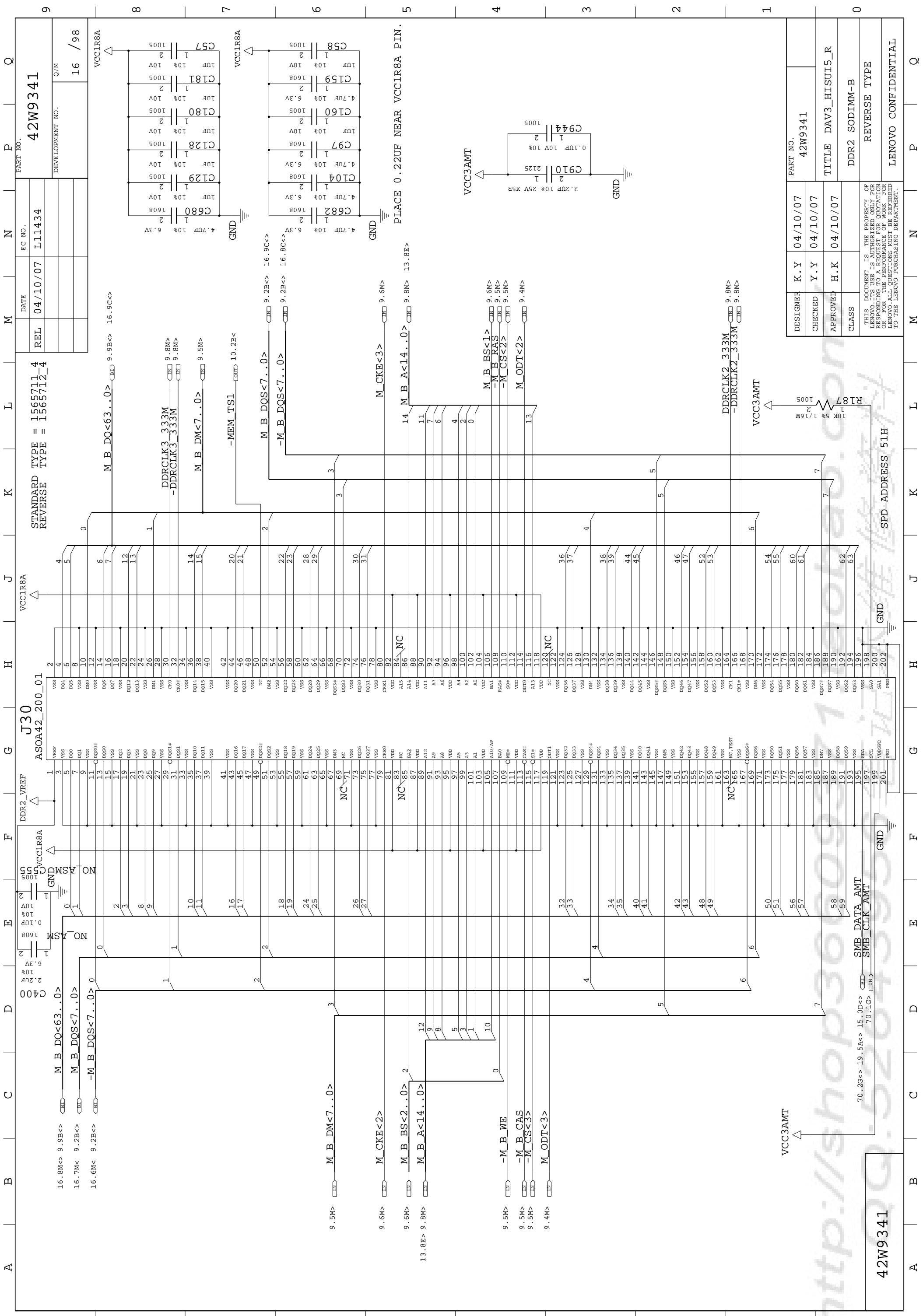

DESIGNER	K. Y.	04/10/07	PART NO.	42W9341
CHECKED	Y. Y.	04/10/07	TITLE	DAV3_HISUI5_R
APPROVED	H. K.	04/10/07	CLASS	DDR2 SODIMM-B
THIS DOCUMENT IS THE PROPERTY OF LENOVO. IT IS TO BE USED ONLY FOR THE PROJECT AND NOT TO BE REPRODUCED, COPIED, OR FOR THE PERFORMANCE OF WORK. ALL QUESTIONS MUST BE REFERRED TO THE LENOVO PURCHASING DEPARTMENT.				
REVERSE TYPE				
LENOVO CONFIDENTIAL				

42W9341



9	A	B	C	D	E	F	G	H	J	K	L	M	N	P	Q
												REL	DATE	EC NO.	PART NO.
												04/10/07	L11434		42W9341
															DEVELOPMENT NO.
															Q/M
															17 / 98

VCC0R9A

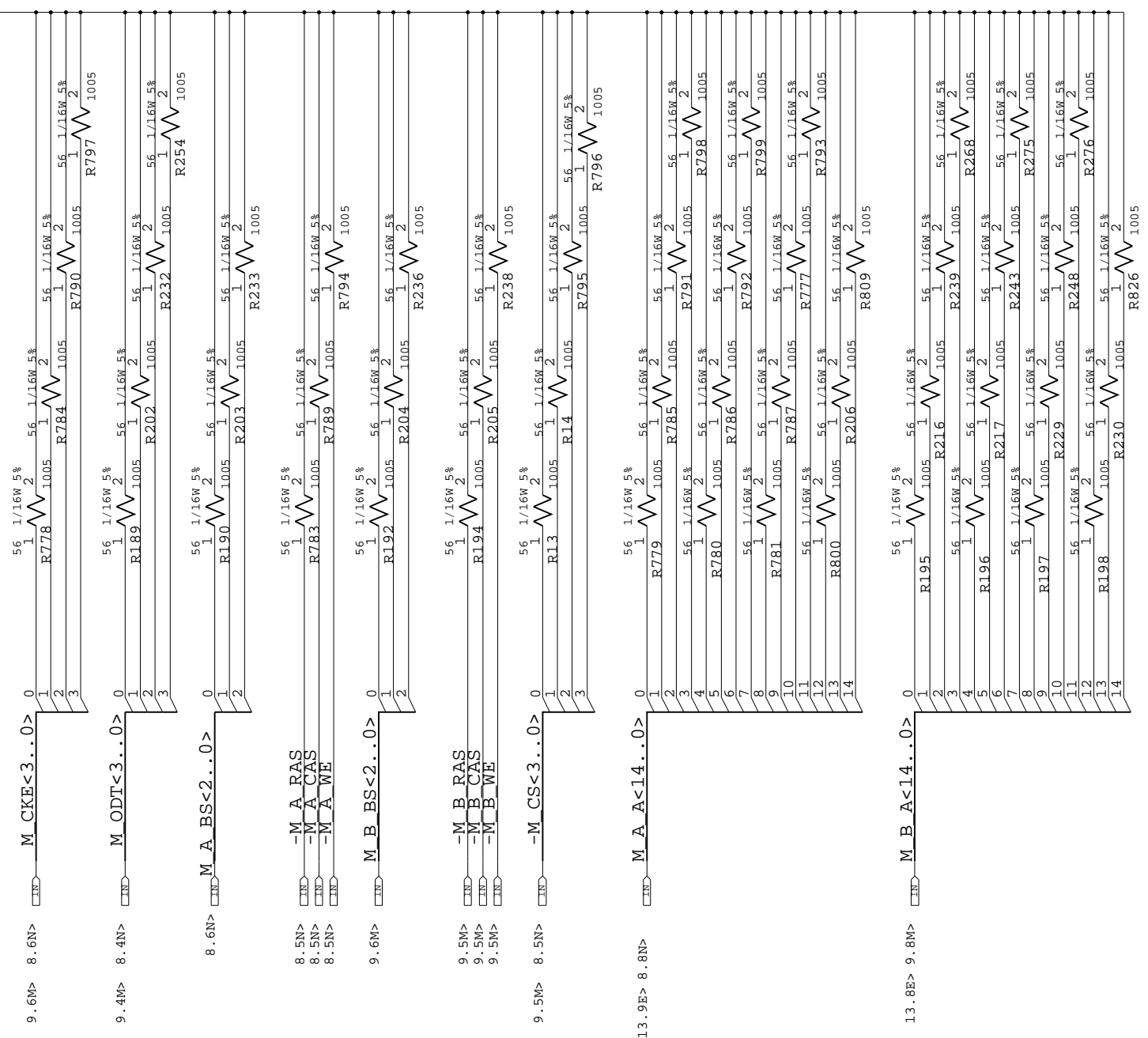

DESIGNER	K. Y	04/10/07	PART NO.	42W9341
CHECKED	Y. Y	04/10/07	TITLE	DAV3_HISUI5_R
APPROVED	H. K	04/10/07	CLASS	DDR-2 TERMINATION
THIS DOCUMENT IS THE PROPERTY OF LENOVO. IT IS TO BE USED ONLY FOR THE PURPOSES SPECIFIED IN THE TITLE. ANY REUSE OR REPRODUCTION WITHOUT THE WRITTEN PERMISSION OF LENOVO IS STRICTLY PROHIBITED. ALL QUESTIONS MUST BE REFERRED TO THE LENOVO PURCHASING DEPARTMENT.				

http://shop36609371.taobao.com 笔记本维修资料

42W9341

9	A	B	C	D	E	F	G	H	J	K	L	M	N	P	Q
---	---	---	---	---	---	---	---	---	---	---	---	---	---	---	---

REL	DATE	EC NO.	PART NO.
04/10/07	04/10/07	L11434	42W9341
			DEVELOPMENT NO.
			Q/M
			18 / 98

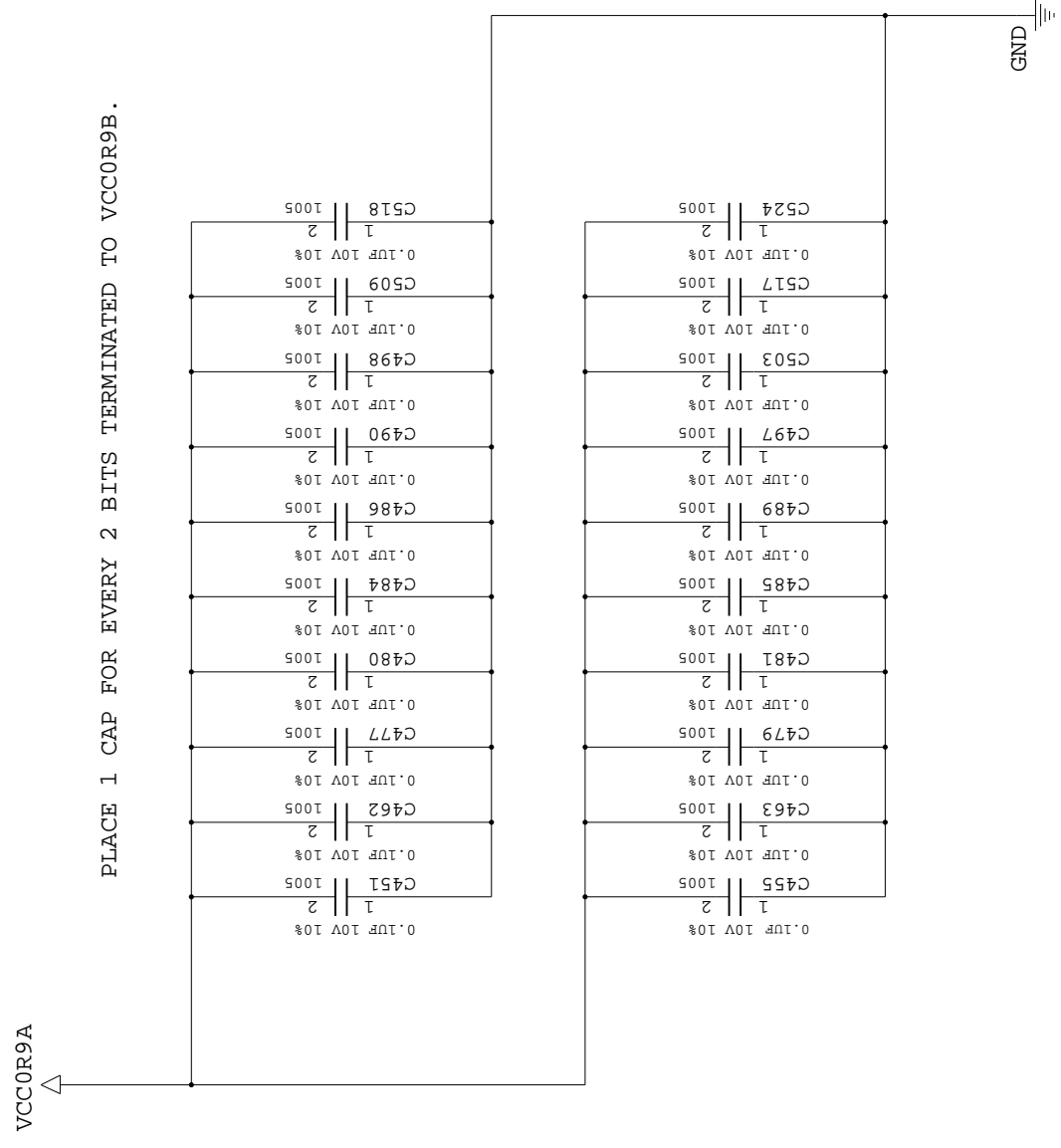

DESIGNER	K.Y	04/10/07	PART NO.
CHECKED	Y.Y	04/10/07	42W9341
APPROVED	H.K	04/10/07	TITLE DAV3_HISUI5_R
CLASS			DDR-2 DECOUPLING
THIS DOCUMENT IS THE PROPERTY OF LENOVO. IT IS LOANED TO YOU FOR USE ONLY. IT IS NOT TO BE REPRODUCED OR TRANSMITTED IN ANY FORM OR BY ANY MEANS, ELECTRONIC OR MECHANICAL, INCLUDING PHOTOCOPYING, RECORDING, OR BY ANY INFORMATION STORAGE AND RETRIEVAL SYSTEM, WITHOUT PERMISSION IN WRITING FROM LENOVO. ALL QUESTIONS MUST BE REFERRED TO THE LENOVO PURCHASING DEPARTMENT.			
			LENOVO CONFIDENTIAL

http://shop36609371.taobao.com 笔记本维修资料

42W9341

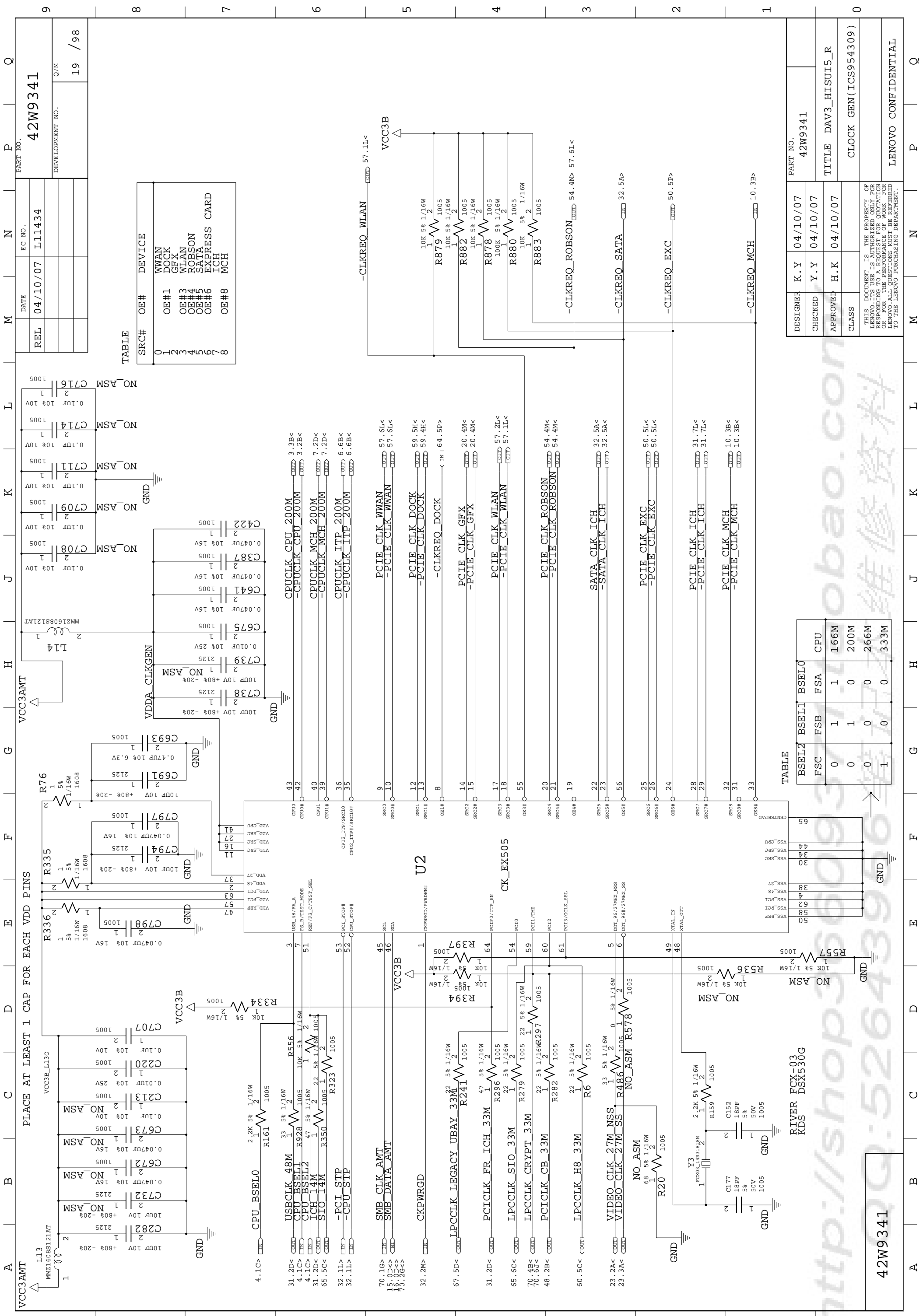

TABLE

SRC#	OE#	DEVICE
0	OE#1	WWAN DOCK GFX
1	OE#3	WLAN ROBSON
2	OE#4	SATA EXPRESS CARD
3	OE#5	ICH
4	OE#6	MCH
5	OE#8	

TABLE

BSEL2	BSEL1	BSEL0	FSC	FSB	FSA	CPU
0	1	1	0	1	1	166M
0	1	0	0	1	0	200M
0	0	0	0	0	0	266M
1	0	0	1	0	0	333M

DESIGNER	K.Y	04/10/07	PART NO.	42W9341
CHECKED	Y.Y	04/10/07	TITLE	DAV3_HISUI5_R
APPROVED	H.K	04/10/07	CLASS	CLOCK GEN(ICS954309)
THIS DOCUMENT IS THE PROPERTY OF LENOVO. IT IS LOANED TO YOU FOR TESTING AND EVALUATION PURPOSES ONLY. IT IS NOT TO BE REPRODUCED OR TRANSMITTED IN ANY FORM OR BY ANY MEANS, ELECTRONIC OR MECHANICAL, INCLUDING PHOTOCOPYING, RECORDING, OR BY ANY INFORMATION STORAGE AND RETRIEVAL SYSTEM. FOR MORE INFORMATION, CONTACT THE LENOVO PURCHASING DEPARTMENT.				

42W9341

RIVER FCX-03  
KDS DSX530G

REL	04/10/07	EC NO.	L11434	PART NO.	42W9341
DEVELOPMENT NO.					
					19 / 98

REL	04/10/07	L11434	42W9341
DATE	04/10/07	L11434	42W9341
EC NO.			
PART NO.			
DEVELOPMENT NO.			
Q/M			20 / 98

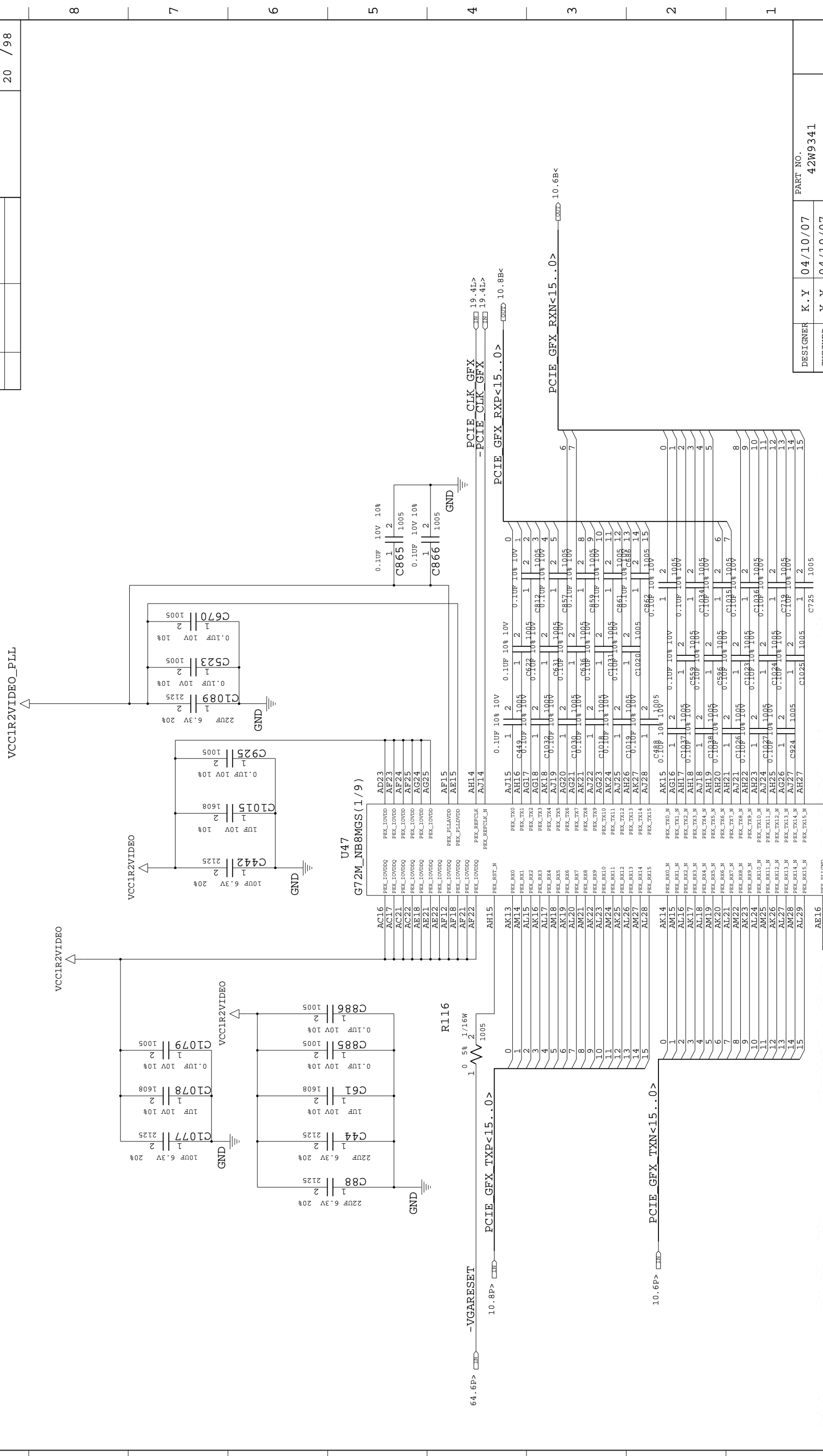

DESIGNER	K.Y	04/10/07	PART NO.	42W9341
CHECKED	Y.Y	04/10/07	TITLE	DAV3_HISUI5_R
APPROVED	H.K	04/10/07	NVIDIA MEP43(1/6) :	PEG I/F
CLASS				

THIS DOCUMENT IS THE PROPERTY OF  
LENOVO. IT IS LOANED TO YOU FOR USE ONLY.  
RESPONDING TO A REQUEST FOR QUOTATION  
OR FOR THE PERFORMANCE OF WORK FOR  
LENOVO. ALL QUESTIONS MUST BE REFERRED  
TO THE LENOVO PURCHASING DEPARTMENT.

http://shop36609371.taobao.com 笔记本维修资料

42W9341



**VCC1R2VIDEO\_PLL**

REL 04/10/07 L11434

DATE

EC NO. L11434

PART NO. 42W9341

DEVELOPMENT NO. Q/M

22 / 98

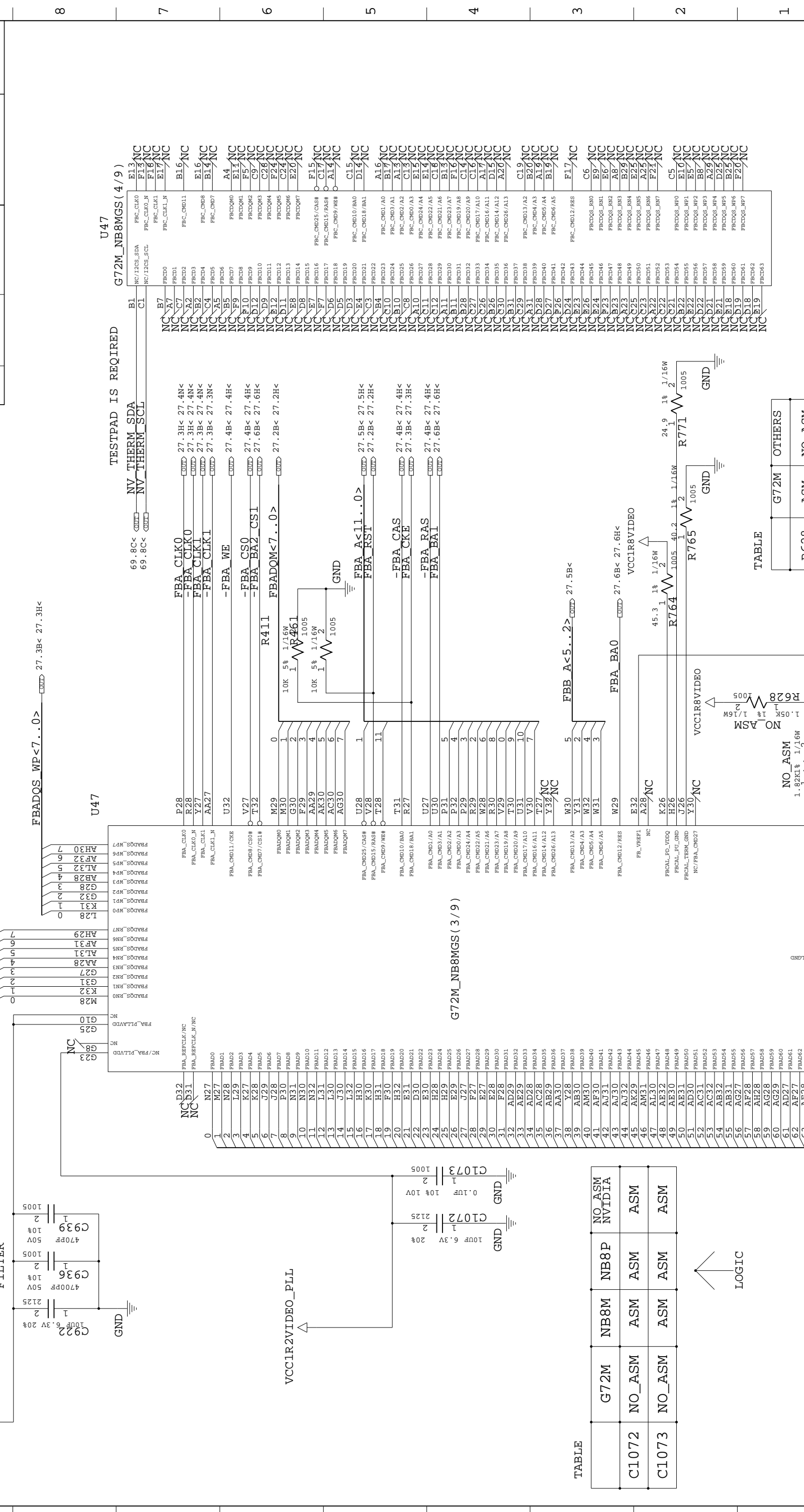

**TESTPAD IS REQUIRED**

**G72M\_NB8MGS (4/9)**

**U47**

69.8C< NV THERM\_SDA  
69.8C< NV THERM\_SCL

**G72M\_NB8MGS (3/9)**

**U49**

FBADOS\_RN<7..0> 27.3B< 27.3H<  
FBADOS\_WP<7..0> 27.3B< 27.3H<

**TABLE**

G72M	NO_ASM	NB8P	NO_ASM	NVIDIA	NO_ASM
C1072	NO_ASM	NB8M	ASM	NVIDIA	ASM
C1073	NO_ASM	NB8M	ASM	NVIDIA	ASM

**TABLE**

R628	ASM	G72M	OTHERS
C1075	NO_ASM		
R650	NO_ASM		
R404	NO_ASM		
Q86	NO_ASM		

**TABLE**

R628	ASM	G72M	OTHERS
C1075	NO_ASM		
R650	NO_ASM		
R404	NO_ASM		
Q86	NO_ASM		

**TABLE**

R628	ASM	G72M	OTHERS
C1075	NO_ASM		
R650	NO_ASM		
R404	NO_ASM		
Q86	NO_ASM		

**TABLE**

R628	ASM	G72M	OTHERS
C1075	NO_ASM		
R650	NO_ASM		
R404	NO_ASM		
Q86	NO_ASM		

**TABLE**

R628	ASM	G72M	OTHERS
C1075	NO_ASM		
R650	NO_ASM		
R404	NO_ASM		
Q86	NO_ASM		

**TABLE**

R628	ASM	G72M	OTHERS
C1075	NO_ASM		
R650	NO_ASM		
R404	NO_ASM		
Q86	NO_ASM		

**TABLE**

R628	ASM	G72M	OTHERS
C1075	NO_ASM		
R650	NO_ASM		
R404	NO_ASM		
Q86	NO_ASM		

**TABLE**

R628	ASM	G72M	OTHERS
C1075	NO_ASM		
R650	NO_ASM		
R404	NO_ASM		
Q86	NO_ASM		

**TABLE**

R628	ASM	G72M	OTHERS
C1075	NO_ASM		
R650	NO_ASM		
R404	NO_ASM		
Q86	NO_ASM		

**TABLE**

R628	ASM	G72M	OTHERS
C1075	NO_ASM		
R650	NO_ASM		
R404	NO_ASM		
Q86	NO_ASM		

**TABLE**

R628	ASM	G72M	OTHERS
C1075	NO_ASM		
R650	NO_ASM		
R404	NO_ASM		
Q86	NO_ASM		

**TABLE**

R628	ASM	G72M	OTHERS
C1075	NO_ASM		
R650	NO_ASM		
R404	NO_ASM		
Q86	NO_ASM		

**TABLE**

R628	ASM	G72M	OTHERS
C1075	NO_ASM		
R650	NO_ASM		
R404	NO_ASM		
Q86	NO_ASM		

**TABLE**

R628	ASM	G72M	OTHERS
C1075	NO_ASM		
R650	NO_ASM		
R404	NO_ASM		
Q86	NO_ASM		

**TABLE**

R628	ASM	G72M	OTHERS
C1075	NO_ASM		
R650	NO_ASM		
R404	NO_ASM		
Q86	NO_ASM		

**TABLE**

R628	ASM	G72M	OTHERS
C1075	NO_ASM		
R650	NO_ASM		
R404	NO_ASM		
Q86	NO_ASM		

**TABLE**

R628	ASM	G72M	OTHERS
C1075	NO_ASM		
R650	NO_ASM		
R404	NO_ASM		
Q86	NO_ASM		

**TABLE**

R628	ASM	G72M	OTHERS
C1075	NO_ASM		
R650	NO_ASM		
R404	NO_ASM		
Q86	NO_ASM		

**TABLE**

R628	ASM	G72M	OTHERS
C1075	NO_ASM		
R650	NO_ASM		
R404	NO_ASM		
Q86	NO_ASM		

**TABLE**

R628	ASM	G72M	OTHERS
C1075	NO_ASM		
R650	NO_ASM		
R404	NO_ASM		
Q86	NO_ASM		

**TABLE**

R628	ASM	G72M	OTHERS
C1075	NO_ASM		
R650	NO_ASM		
R404	NO_ASM		
Q86	NO_ASM		

**TABLE**

R628	ASM	G72M	OTHERS
C1075	NO_ASM		
R650	NO_ASM		
R404	NO_ASM		
Q86	NO_ASM		

**TABLE**

R628	ASM	G72M	OTHERS
C1075	NO_ASM		
R650	NO_ASM		
R404	NO_ASM		
Q86	NO_ASM		

**TABLE**

R628	ASM	G72M	OTHERS
C1075	NO_ASM		
R650	NO_ASM		
R404	NO_ASM		
Q86	NO_ASM		

**TABLE**

R628	ASM	G72M	OTHERS
C1075	NO_ASM		
R650	NO_ASM		
R404	NO_ASM		
Q86	NO_ASM		

**TABLE**

R628	ASM	G72M	OTHERS
C1075	NO_ASM		
R650	NO_ASM		
R404	NO_ASM		
Q86	NO_ASM		

**TABLE**

R628	ASM	G72M	OTHERS
C1075	NO_ASM		
R650	NO_ASM		
R404	NO_ASM		
Q86	NO_ASM		

**TABLE**

R628	ASM	G72M	OTHERS
C1075	NO_ASM		
R650	NO_ASM		
R404	NO_ASM		
Q86	NO_ASM		

**TABLE**

R628	ASM	G72M	OTHERS
C1075	NO_ASM		
R650	NO_ASM		
R404	NO_ASM		
Q86	NO_ASM		

**TABLE**

R628	ASM	G72M	OTHERS
C1075	NO_ASM		
R650	NO_ASM		
R404	NO_ASM		
Q86	NO_ASM		

**TABLE**

R628	ASM	G72M	OTHERS
C1075	NO_ASM		
R650	NO_ASM		
R404	NO_ASM		
Q86	NO_ASM		

**TABLE**

R628	ASM	G72M	OTHERS
C1075	NO_ASM		
R650	NO_ASM		
R404	NO_ASM		
Q86	NO_ASM		

**TABLE**

R628	ASM	G72M	OTHERS
C1075	NO_ASM		
R650	NO_ASM		
R404	NO_ASM		
Q86	NO_ASM		

**TABLE**

R628	ASM	G72M	OTHERS
C1075	NO_ASM		
R650	NO_ASM		
R404	NO_ASM		
Q86	NO_ASM		

**TABLE**

R628	ASM	G72M	OTHERS
C1075	NO_ASM		
R650	NO_ASM		
R404	NO_ASM		
Q86	NO_ASM		

**TABLE**

R628	ASM	G72M	OTHERS
C1075	NO_ASM		
R650	NO_ASM		
R404	NO_ASM		
Q86	NO_ASM		

**TABLE**

R628	ASM	G72M	OTHERS
C1075	NO_ASM		
R650	NO_ASM		
R404	NO_ASM		
Q86	NO_ASM		

**TABLE**

R628	ASM	G72M	OTHERS
C1075	NO_ASM		
R650	NO_ASM		
R404	NO_ASM		
Q86	NO_ASM		

**TABLE**

R628	ASM	G72M	OTHERS
C1075	NO_ASM		
R650	NO_ASM		
R404	NO_ASM		
Q86	NO_ASM		

**TABLE**

R628	ASM	G72M	OTHERS
C1075	NO_ASM		
R650	NO_ASM		
R404	NO_ASM		
Q86	NO_ASM		

**TABLE**

R628	ASM	G72M	OTHERS
C1075	NO_ASM		
R650	NO_ASM		
R404	NO_ASM		
Q86	NO_ASM		

**TABLE**

R628	ASM	G72M	OTHERS
C1075	NO_ASM		
R650	NO_ASM		
R404	NO_ASM		
Q86	NO_ASM		

**TABLE**

R628	ASM	G72M	OTHERS
C1075	NO_ASM		
R650	NO_ASM		
R404	NO_ASM		
Q86	NO_ASM		

**TABLE**

R628	ASM	G72M	OTHERS
C1075	NO_ASM		
R650	NO_ASM		
R404	NO_ASM		
Q86	NO_ASM		

**TABLE**

R628	ASM	G72M	OTHERS
C1075	NO_ASM		
R650	NO_ASM		
R404	NO_ASM		
Q86	NO_ASM		

**TABLE**

R628	ASM	G72M	OTHERS
C1075	NO_ASM		
R650	NO_ASM		
R404	NO_ASM		
Q86	NO_ASM		

**TABLE**

R628	ASM	G72M	OTHERS
C1075	NO_ASM		
R650	NO_ASM		
R404	NO_ASM		
Q86	NO_ASM		

**TABLE**

R628	ASM	G72M	OTHERS
C1075	NO_ASM		
R650	NO_ASM		
R404	NO_ASM		
Q86	NO_ASM		

**TABLE**

R628	ASM	G72M	OTHERS
C1075	NO_ASM		
R650	NO_ASM		
R404	NO_ASM		
Q86	NO_ASM		

**TABLE**

R628	ASM	G72M	OTHERS
C1075	NO_ASM		
R650	NO_ASM		
R404	NO_ASM		
Q86	NO_ASM		

**TABLE**

R628	ASM	G72M	OTHERS
C1075	NO_ASM		
R650	NO_ASM		
R404	NO_ASM		
Q86	NO_ASM		

**TABLE**

R628	ASM	G72M	OTHERS
C1075	NO_ASM		
R650	NO_ASM		
R404	NO_ASM		
Q86	NO_ASM		

**TABLE**

R628	ASM	G72M	OTHERS
C1075	NO_ASM		
R650	NO_ASM		
R404	NO_ASM		
Q86	NO_ASM		

**TABLE**

R628	ASM	G72M	OTHERS
C1075	NO_ASM		
R650	NO_ASM		
R404	NO_ASM		
Q86	NO_ASM		

**TABLE**

R628	ASM	G72M	OTHERS
C1075	NO_ASM		
R650	NO_ASM		
R404	NO_ASM		
Q86	NO_ASM		

**TABLE**

R628	ASM	G72M	OTHERS
C1075	NO_ASM		
R650	NO_ASM		
R404	NO_ASM		
Q86	NO_ASM		

**TABLE**

R628	ASM	G72M	OTHERS
C1075	NO_ASM		
R650	NO_ASM		
R404	NO_ASM		
Q86	NO_ASM		

**TABLE**

R628	ASM	G72M	OTHERS
C1075	NO_ASM		
R650	NO_ASM		
R404	NO_ASM		
Q86	NO_ASM		

**TABLE**

R628	ASM	G72M	
------	-----	------	--

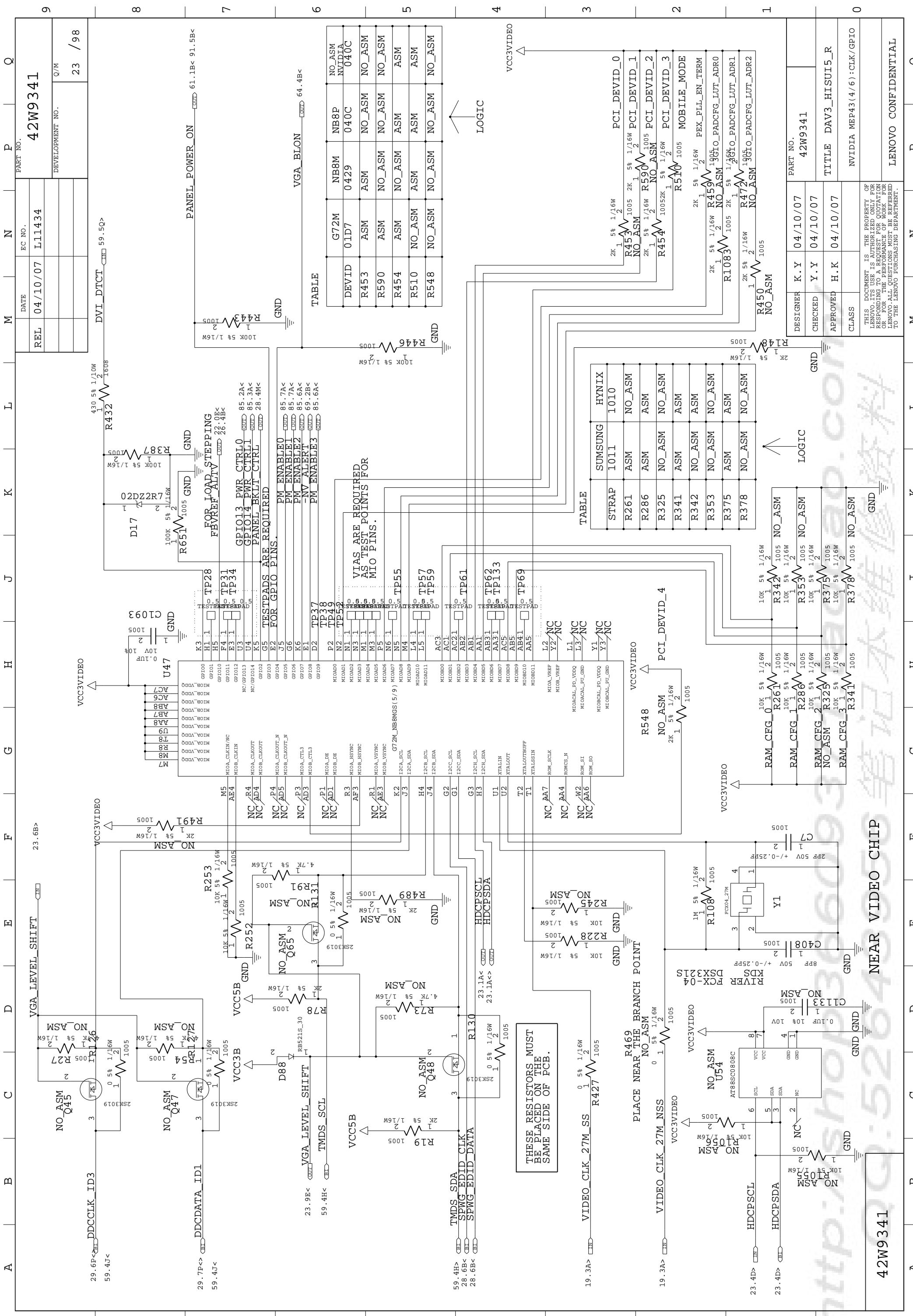

REL	04/10/07	L11434	42W9341
DATE	04/10/07	L11434	42W9341
EC NO.			
PART NO.			
DEVELOPMENT NO.			
Q/M			
			23 / 98

DESIGNER	CHECKED	APPROVED	CLASS	DESIGNER	CHECKED	APPROVED	CLASS
K.Y	Y.Y	H.K		K.Y	Y.Y	H.K	
04/10/07	04/10/07	04/10/07		04/10/07	04/10/07	04/10/07	
42W9341	42W9341	42W9341		42W9341	42W9341	42W9341	
TITLE				TITLE			
DAV3_HISUI5_R				DAV3_HISUI5_R			
CLASS				CLASS			
NVIDIA MEP43(4/6):CLK/GPIO				NVIDIA MEP43(4/6):CLK/GPIO			

NEAR VIDEO CHIP

42W9341

LENOVO CONFIDENTIAL

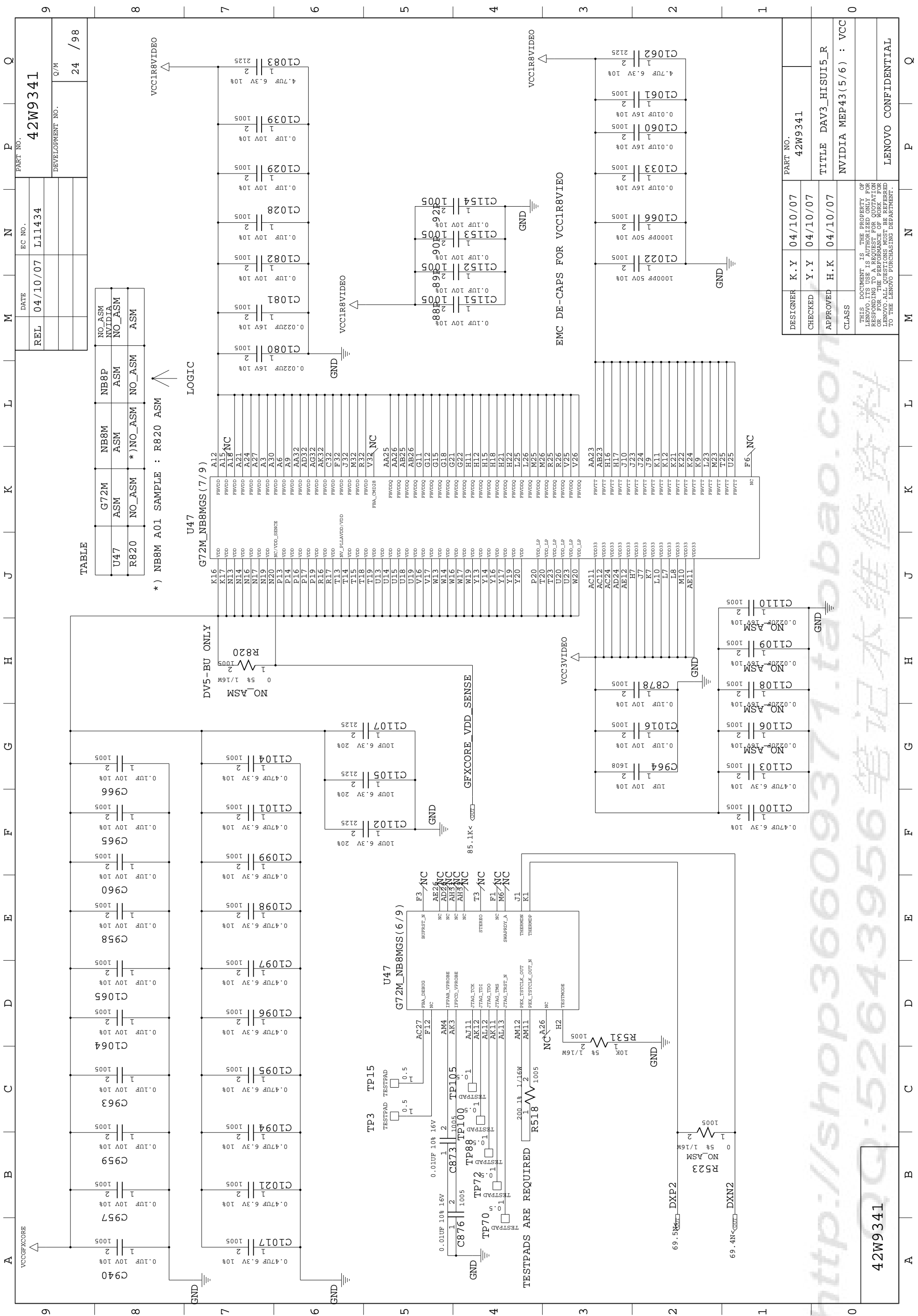

TABLE

U47	G72M ASM	NB8P ASM	NB8M ASM	NB8P ASM	NO_ASM
R820	NO_ASM	NO_ASM	NO_ASM	NO_ASM	ASM

\* ) NB8M A01 SAMPLE : R820 ASM

DESIGNER	K.Y	04/10/07	PART NO.	42W9341
CHECKED	Y.Y	04/10/07	TITLE	DAV3_HISUI5_R
APPROVED	H.K	04/10/07		NVIDIA MEP43(5/6) : VCC
CLASS				

42W9341

http://shop36609371.taobao.com 笔记本维修资料

THIS DOCUMENT IS THE PROPERTY OF LENOVO. IT IS LOANED TO YOU FOR USE ONLY. IT IS NOT TO BE REPRODUCED OR TRANSMITTED IN ANY FORM OR BY ANY MEANS, ELECTRONIC OR MECHANICAL, INCLUDING PHOTOCOPYING, RECORDING, OR BY ANY INFORMATION STORAGE AND RETRIEVAL SYSTEM. FOR MORE INFORMATION, CONTACT THE LENOVO PURCHASING DEPARTMENT.

LENOVO CONFIDENTIAL



M	DATE	EC NO.	PART NO.
REL	04/10/07	L11434	42W9341
			DEVELOPMENT NO.
			Q/M
			25 / 98

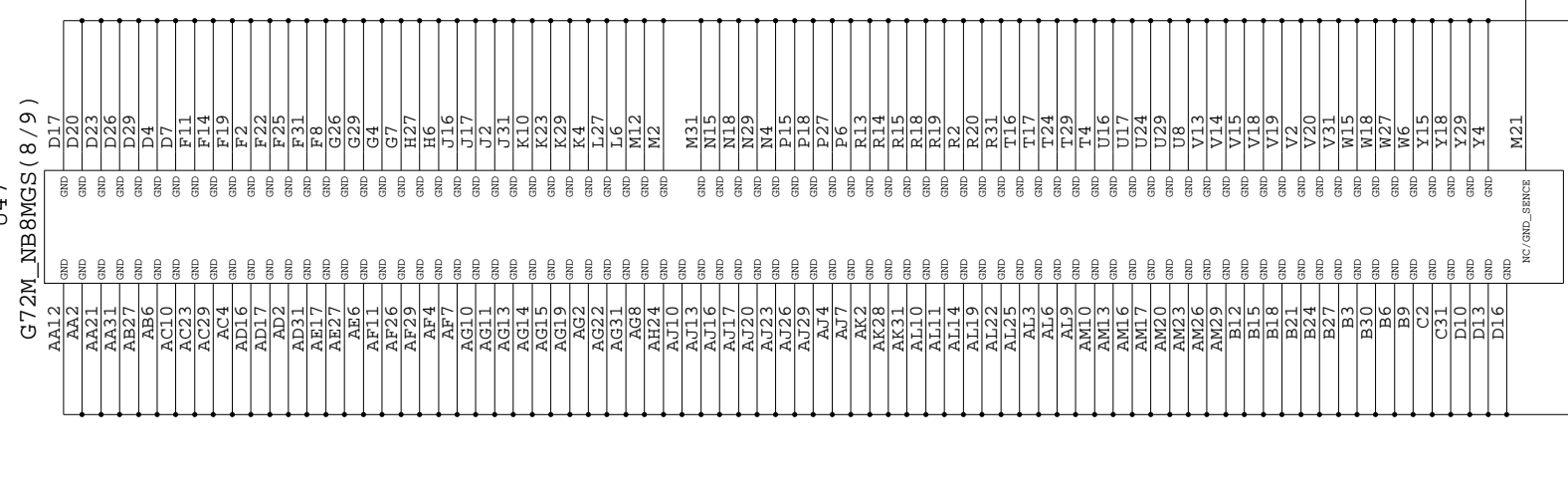

**U47**  
G72M\_MB8MGS (9/9)

NC
AC26
NC
AG12
NC
AH13
NC
AM8
NC
AN9
NC
BC20
NC
CD1
NC
DE6
NC
EF6
NC
FG6
NC
GH6
NC
HI6
NC
IJ6
NC
KK6
NC
LL6
NC
MM6
NC
NN6
NC
OO6
NC
PP6
NC
QQ6
NC
RR6
NC
SS6
NC
TT6
NC
UU6
NC
VV6
NC
WW6
NC
XX6
NC
YY6
NC
ZZ6
NC

TABLE

U47	G72M	NB8M	NB8P	NO_ASM	NO_ASM
	ASM	ASM	ASM	NVIDIA	NVIDIA
R822	NO_ASM *	NO_ASM	NO_ASM	NO_ASM	ASM

\*) NB8M A01 SAMPLE : R822 ASM  
LOGIC



DESIGNER	K. Y	04/10/07	PART NO.	42W9341
CHECKED	Y. Y	04/10/07	TITLE	DAV3_HISUI5_R
APPROVED	H. K	04/10/07		NVIDIA MEP43 (6/6) : GND
CLASS				
THIS DOCUMENT IS THE PROPERTY OF LENOVO. IT IS TO BE USED ONLY FOR THE PURPOSES SPECIFIED IN THIS DOCUMENT. ANY REPRODUCTION OR TRANSMISSION OF THIS DOCUMENT WITHOUT THE WRITTEN PERMISSION OF LENOVO IS STRICTLY PROHIBITED. ALL QUESTIONS MUST BE REFERRED TO THE LENOVO PURCHASING DEPARTMENT.				

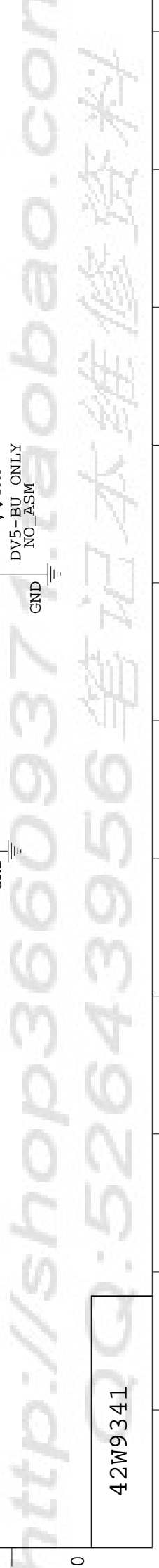

REL	04/10/07	EC NO.	L11434	PART NO.	42W9341
				DEVELOPMENT NO.	26 / 98

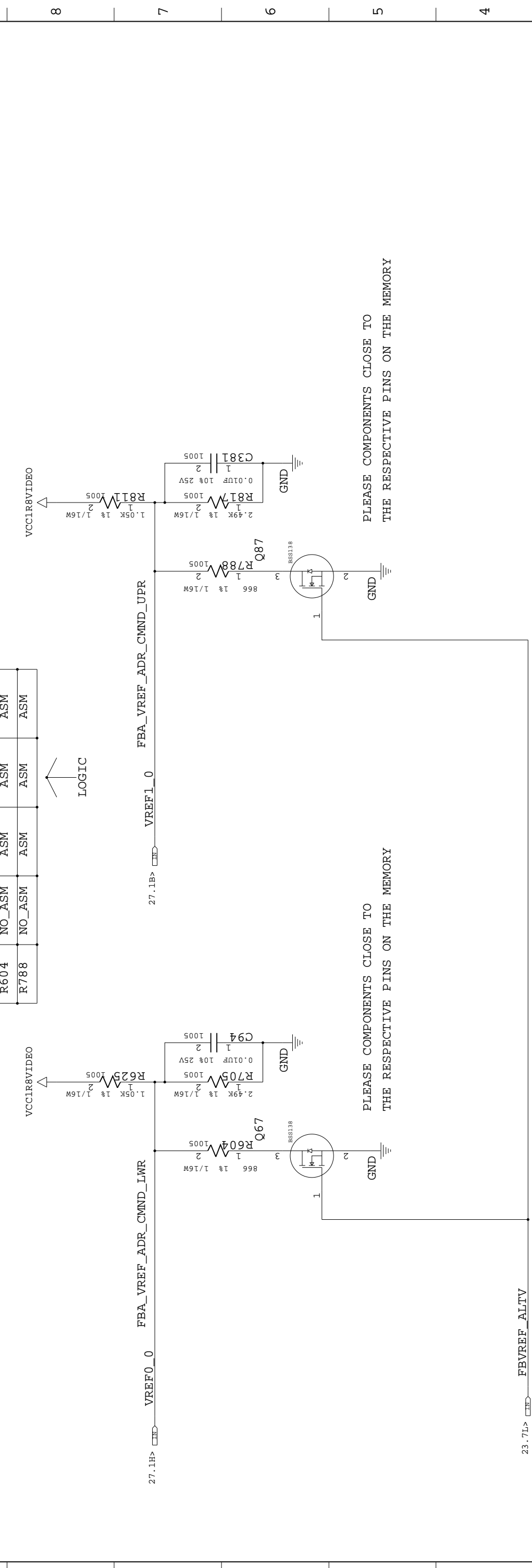

PLEASE COMPONENTS CLOSE TO THE RESPECTIVE PINS ON THE MEMORY

PLEASE COMPONENTS CLOSE TO THE RESPECTIVE PINS ON THE MEMORY

TABLE

Q67	NO_ASM	NB8M	NB8P	NO_ASM	NO_ASM
Q87	NO_ASM	ASM	ASM	NO_ASM	NO_ASM
R604	NO_ASM	ASM	ASM	NO_ASM	NO_ASM
R788	NO_ASM	ASM	ASM	NO_ASM	NO_ASM

DESIGNER	K.Y	04/10/07	PART NO.	42W9341
CHECKED	Y.Y	04/10/07	TITLE	DAV3_HISUI5_R
APPROVED	H.K	04/10/07	CLASS	DYNAMIC MEMORY TERMINATION
THIS DOCUMENT IS THE PROPERTY OF LENOVO. IT IS LOANED TO YOU FOR YOUR USE ONLY. IT IS NOT TO BE REPRODUCED OR TRANSMITTED IN ANY FORM OR BY ANY MEANS, ELECTRONIC OR MECHANICAL, INCLUDING PHOTOCOPYING, RECORDING, OR BY ANY INFORMATION STORAGE AND RETRIEVAL SYSTEM, WITHOUT PERMISSION IN WRITING FROM LENOVO. ALL QUESTIONS MUST BE REFERRED TO THE LENOVO PURCHASING DEPARTMENT.				
LENOVO CONFIDENTIAL				

http://shop36609371.taobao.com 笔记本维修资料

42W9341

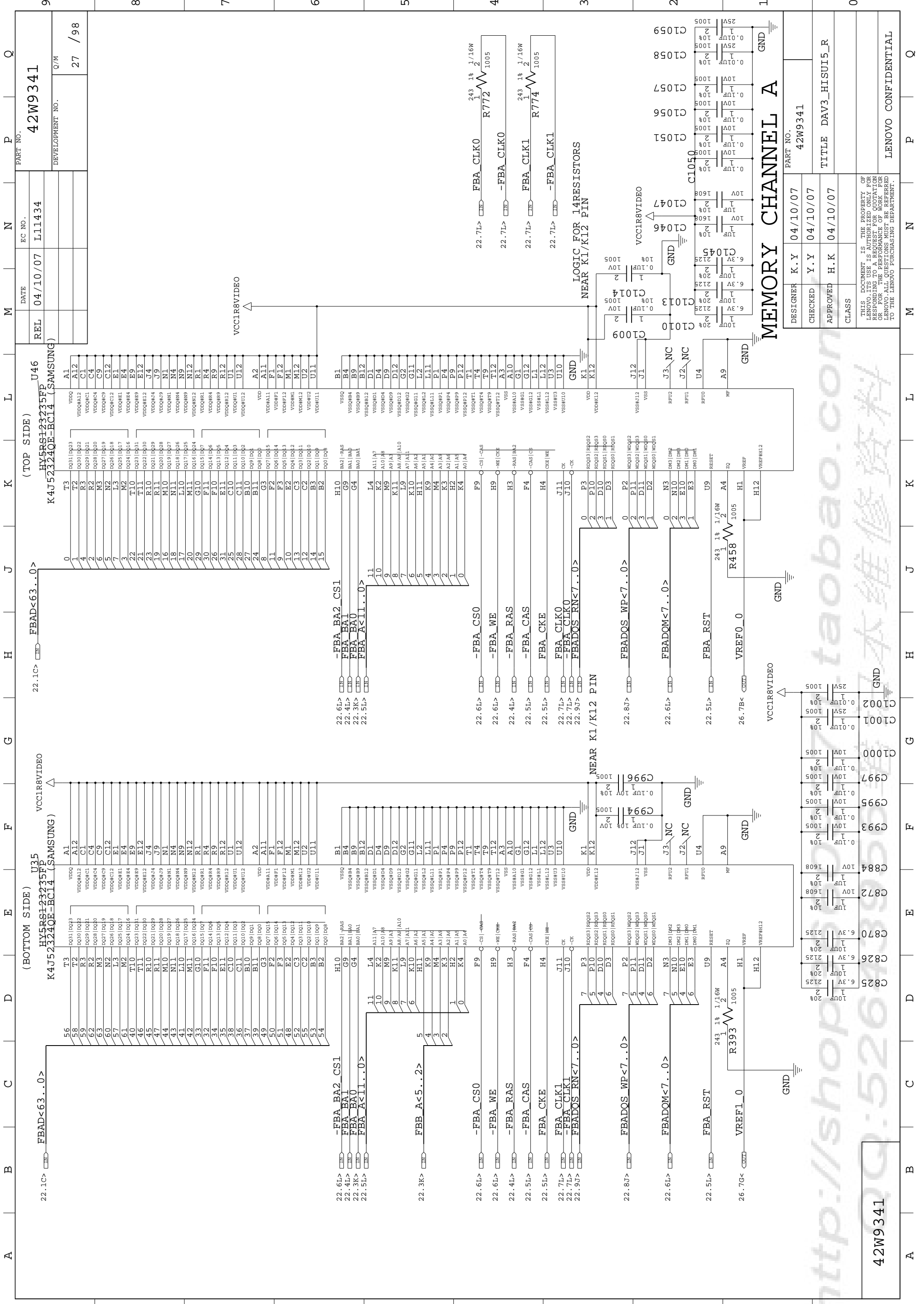

<http://shop36609371.taobao.com>

52643956

http://shop36609371.taobao.com

本维修资料

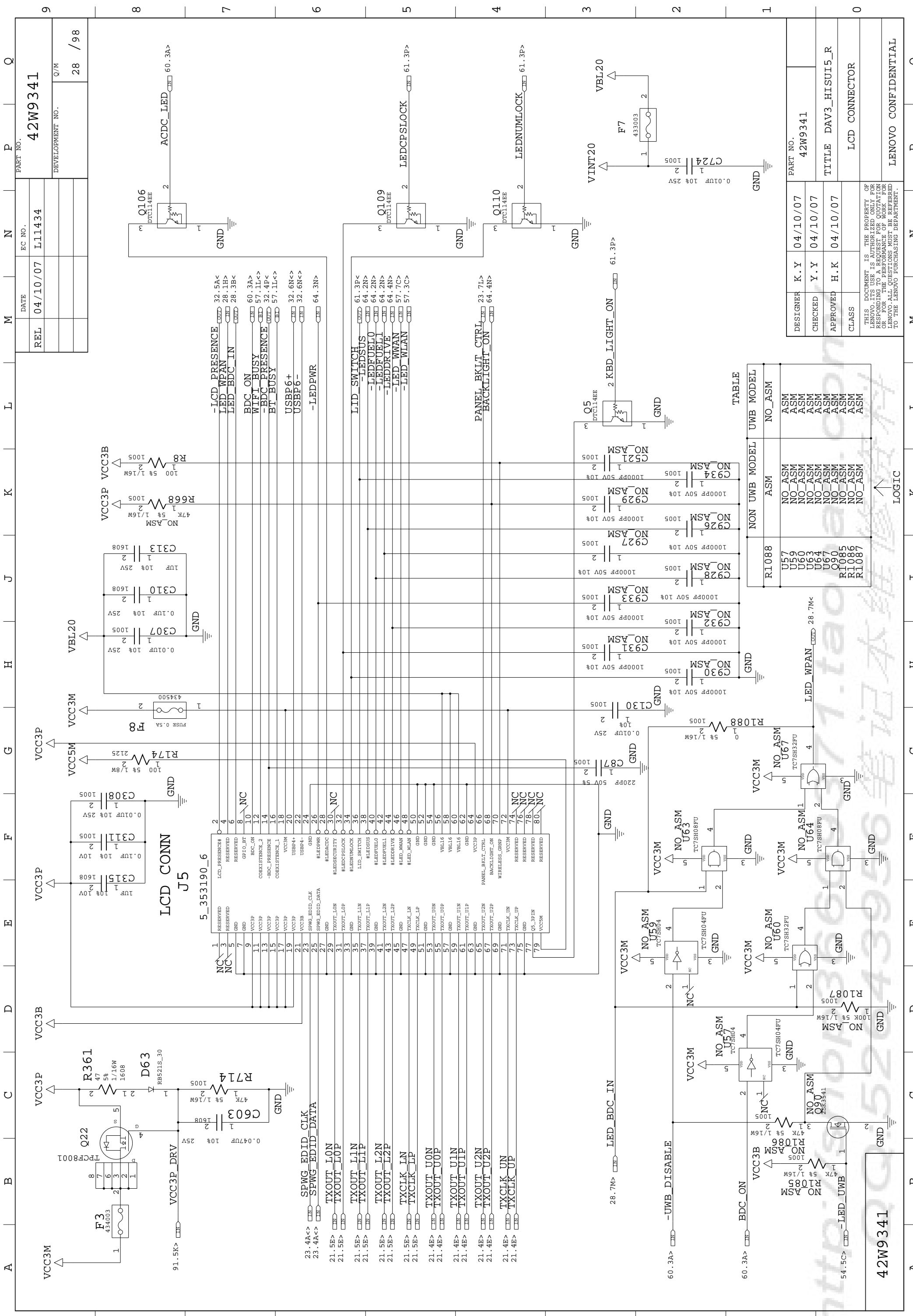

DESIGNER	K. Y	04/10/07	42W9341
CHECKED	Y. Y	04/10/07	
APPROVED	H. K	04/10/07	
CLASS			LCD CONNECTOR
PART NO.		42W9341	
TITLE		DAV3_HISUI5_R	

NO	UWB MODEL	NON UWB MODEL	UWB MODEL	NO_ASM
R1088	ASM	NO_ASM	NO_ASM	NO_ASM
U57	NO_ASM	NO_ASM	NO_ASM	NO_ASM
U59	NO_ASM	NO_ASM	NO_ASM	NO_ASM
U63	NO_ASM	NO_ASM	NO_ASM	NO_ASM
U64	NO_ASM	NO_ASM	NO_ASM	NO_ASM
U67	NO_ASM	NO_ASM	NO_ASM	NO_ASM
O90	NO_ASM	NO_ASM	NO_ASM	NO_ASM
R1085	NO_ASM	NO_ASM	NO_ASM	NO_ASM
R1086	NO_ASM	NO_ASM	NO_ASM	NO_ASM
R1087	NO_ASM	NO_ASM	NO_ASM	NO_ASM

42W9341

LENOVO CONFIDENTIAL

LOGIC

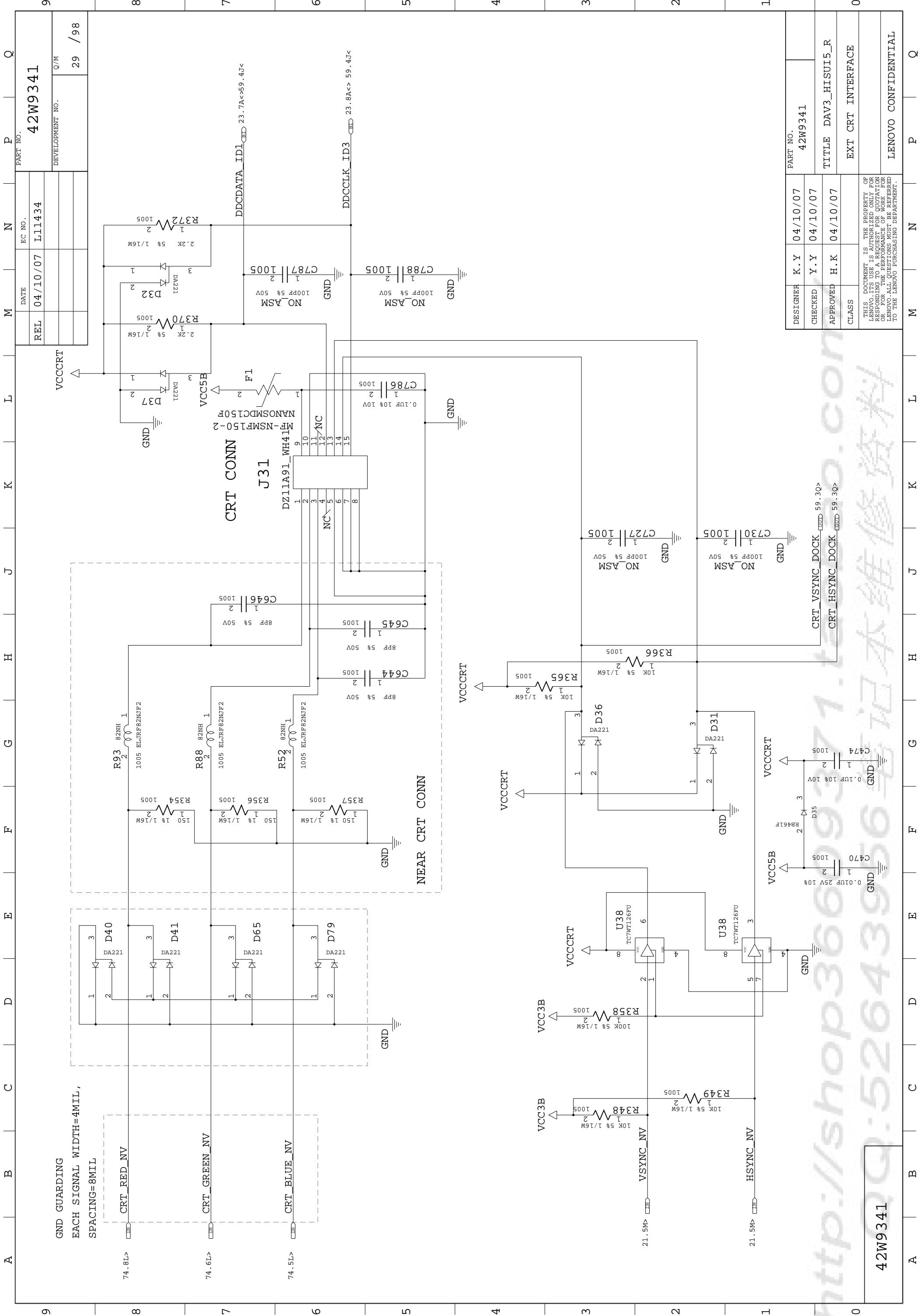

GND GUARDING  
EACH SIGNAL WIDTH=4MIL,  
SPACING=8MIL

74.8L> CRT\_RED\_NV  
74.6L> CRT\_GREEN\_NV  
74.5L> CRT\_BLUE\_NV

NEAR CRT CONN

CRT CONN  
J31  
DZ11A91-WH41

CRT\_VSYNC DOCK  
C475 59.30<  
CRT\_HSYNC DOCK  
C475 59.30<

42W9341

REL	DATE	EC NO.	PART NO.
	04/10/07	L11434	42W9341
			DEVELOPMENT NO.
			Q/M
			29 / 98

DESIGNER	K.Y	04/10/07	PART NO.	42W9341
CHECKED	Y.Y	04/10/07	TITLE	DAV3_HISUI5_R
APPROVED	H.K	04/10/07	EXT CRT INTERFACE	
CLASS				

THIS DOCUMENT IS THE PROPERTY OF  
LENOVO. IT IS LOANED TO YOU FOR  
YOUR USE ONLY. IT IS NOT TO BE  
REPRODUCED, COPIED, DISTRIBUTED,  
OR FOR THE PERFORMANCE OF WORK FOR  
LENOVO. ALL QUESTIONS MUST BE REFERRED  
TO THE LENOVO PURCHASING DEPARTMENT.

LENOVO CONFIDENTIAL

A		B		C		D		E		F		G		H		J		K		L		M		N		P		Q			
REL		DATE		EC NO.		PART NO.		REL		DATE		EC NO.		PART NO.		REL		DATE		EC NO.		PART NO.		REL		DATE		EC NO.		PART NO.	
42W9341		04/10/07		L11434		42W9341		42W9341		04/10/07		L11434		42W9341		42W9341		04/10/07		L11434		42W9341		42W9341		04/10/07		L11434		42W9341	
																										DEVELOPMENT NO.		Q/M			
																										30		/ 98			

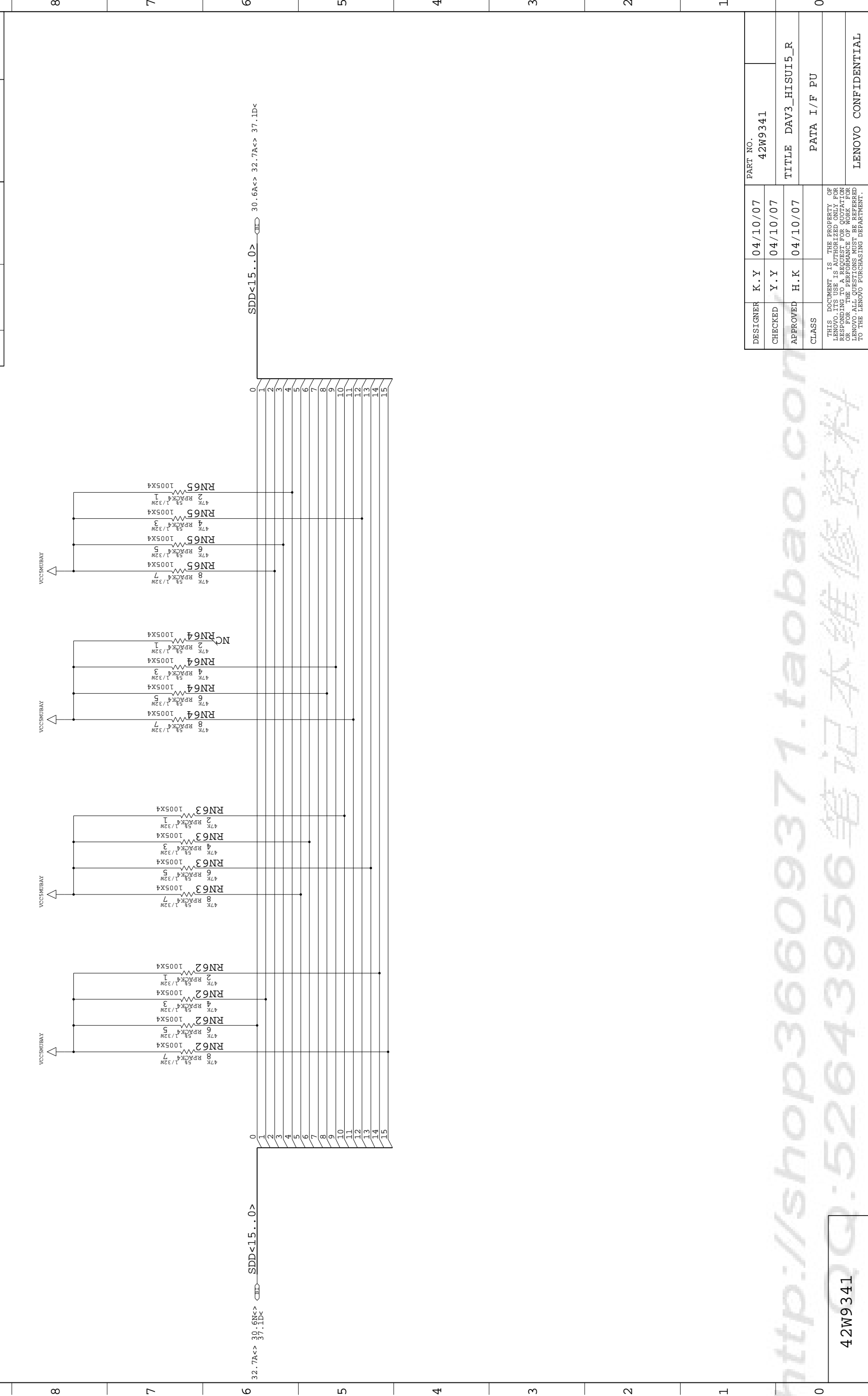

DESIGNER	K.Y	04/10/07	PART NO.	42W9341
CHECKED	Y.Y	04/10/07	TITLE	DAV3_HISUI5_R
APPROVED	H.K	04/10/07	CLASS	PATA I/F PU
THIS DOCUMENT IS THE PROPERTY OF LENOVO. IT IS LOANED TO YOU FOR YOUR WORK. IT IS NOT TO BE REPRODUCED OR TRANSMITTED IN ANY FORM OR BY ANY MEANS, ELECTRONIC OR MECHANICAL, INCLUDING PHOTOCOPYING, RECORDING, OR BY ANY INFORMATION STORAGE AND RETRIEVAL SYSTEM. ALL RIGHTS RESERVED. FOR MORE INFORMATION, CONTACT YOUR LENOVO ACCOUNT MANAGER. FOR ALL QUESTIONS, PLEASE REFER TO THE LENOVO PURCHASING DEPARTMENT.				

http://shop36609371.taobao.com  
 52643956 笔记本维修资料

42W9341



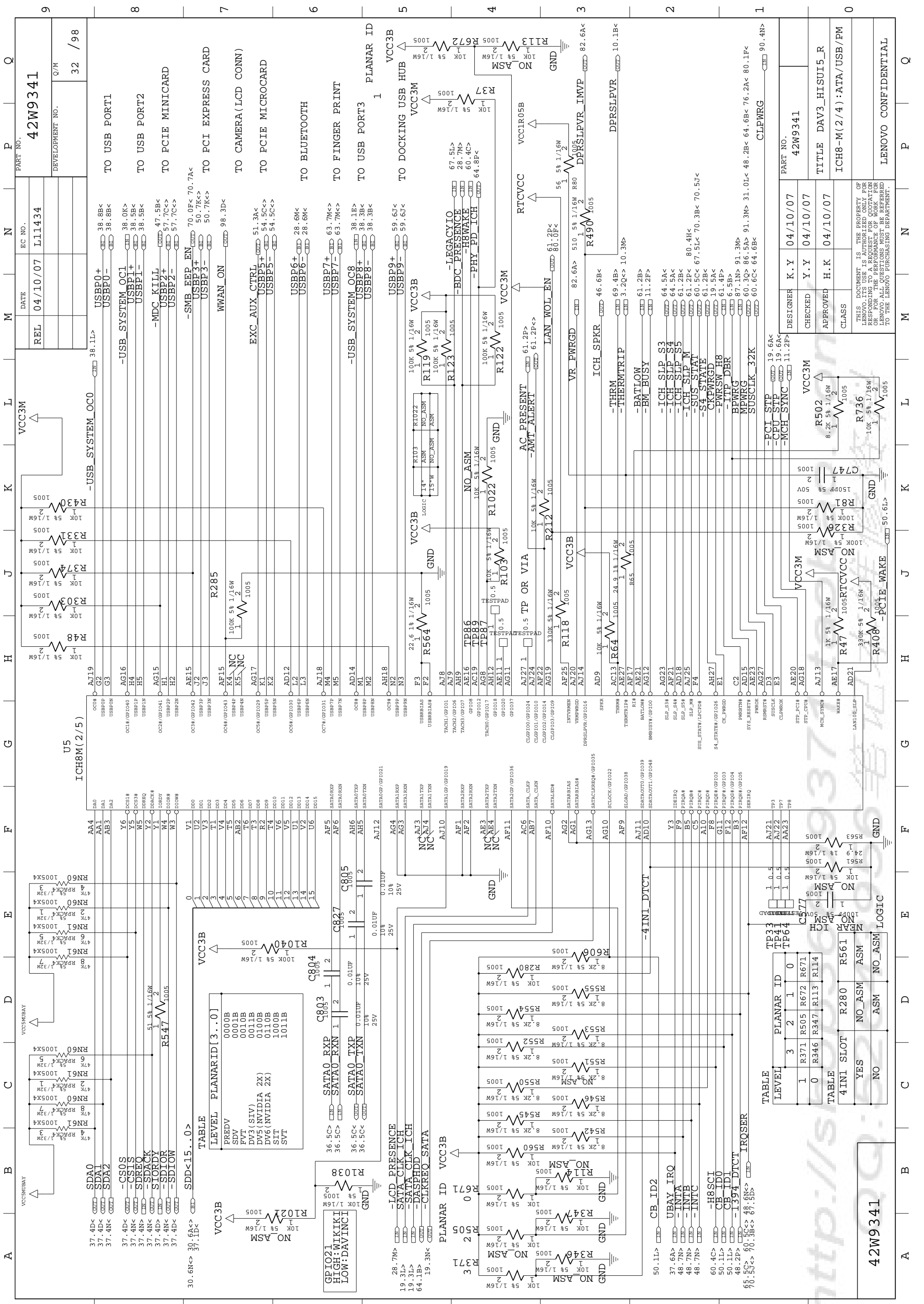

REL	DATE	EC NO.	PART NO.
REL	04/10/07	L11434	42W9341
			DEVELOPMENT NO. Q/M
			32 / 98

DESIGNER	CHECKED	APPROVED	CLASS	DATE	PART NO.
K.Y	Y.Y	H.K	VCC3M	04/10/07	42W9341
					TITLE
					ICH8-M(2/4):ATA/USB/PM

LEVEL	PLANAR ID
1	R371 R505 R672 R671
0	R346 R347 R113 R114

4 IN1 SLOT	PLANAR ID
YES	NO_ASM R280
NO	NO_ASM R561

42W9341

LENOVO CONFIDENTIAL

THIS DOCUMENT IS THE PROPERTY OF LENOVO... ALL QUESTIONS MUST BE REFERRED TO THE LENOVO PURCHASING DEPARTMENT.



REL	DATE	EC NO.	PART NO.
	04/10/07	L11434	42W9341
			DEVELOPMENT NO.
			33 / 98

57.7L>	PCIE_WWAN_RXP	P26	PERP1	N28	0.1UF 10% 10V	PCIE_WWAN_TXP	57.7L<
57.6L>	PCIE_WWAN_RXN	P27	PERN1	N29	C569	PCIE_WWAN_TXN	57.7L<
57.2L>	PCIE_WLAN_RXP	M26	PERT2	L28	C601	PCIE_WLAN_TXP	57.3L<
57.2L>	PCIE_WLAN_RXN	M27	PERN2	L29	C246	PCIE_WLAN_TXN	57.2L<
54.5M>	PCIE_ROBSON_RXP	K26	PERT3	J28	C250	PCIE_ROBSON_TXP	54.5M>
54.4M>	PCIE_ROBSON_RXN	K27	PERN3	J29	C828	PCIE_ROBSON_TXN	54.5M>
50.5L>	PCIE_EXC_RXP	H26	PERT4	G28	C252	PCIE_EXC_TXP	50.4L<
50.5L>	PCIE_EXC_RXN	H27	PERN4	G29	C245	PCIE_EXC_TXN	50.4L<
59.6A>	PCIE_DOCK_RX1P	F26	PERT5	E28	C1067	PCIE_DOCK_TX1P	59.5H<
59.5A>	PCIE_DOCK_RX1N	F27	PERN5	E29	C1076	PCIE_DOCK_TX1N	59.5H<
53.6F>	GLAN_RXP	D26	PERP6/GLAN_RXP	C28	C720	GLAN_TXP	53.6F<
53.6F>	GLAN_RXN	D27	PERN6/GLAN_RXN	C29	C799	GLAN_TXN	53.6F<

U5  
ICH8M(3/5)

DESIGNER	K.Y	04/10/07	PART NO.	42W9341
CHECKED	Y.Y	04/10/07	TITLE	DAV3_HISUI5_R
APPROVED	H.K	04/10/07	CLASS	ICH8-M(3/4):PCI EXPRESS
THIS DOCUMENT IS THE PROPERTY OF LENOVO. IT IS LOANED TO YOU FOR YOUR USE ONLY. IT IS NOT TO BE REPRODUCED OR TRANSMITTED IN ANY FORM OR BY ANY MEANS, ELECTRONIC OR MECHANICAL, INCLUDING PHOTOCOPYING, RECORDING, OR BY ANY INFORMATION STORAGE AND RETRIEVAL SYSTEM, WITHOUT THE WRITTEN PERMISSION OF LENOVO. ALL QUESTIONS MUST BE REFERRED TO THE LENOVO PURCHASING DEPARTMENT.				

http://shop36609371.taobao.com 笔记本维修资料

42W9341

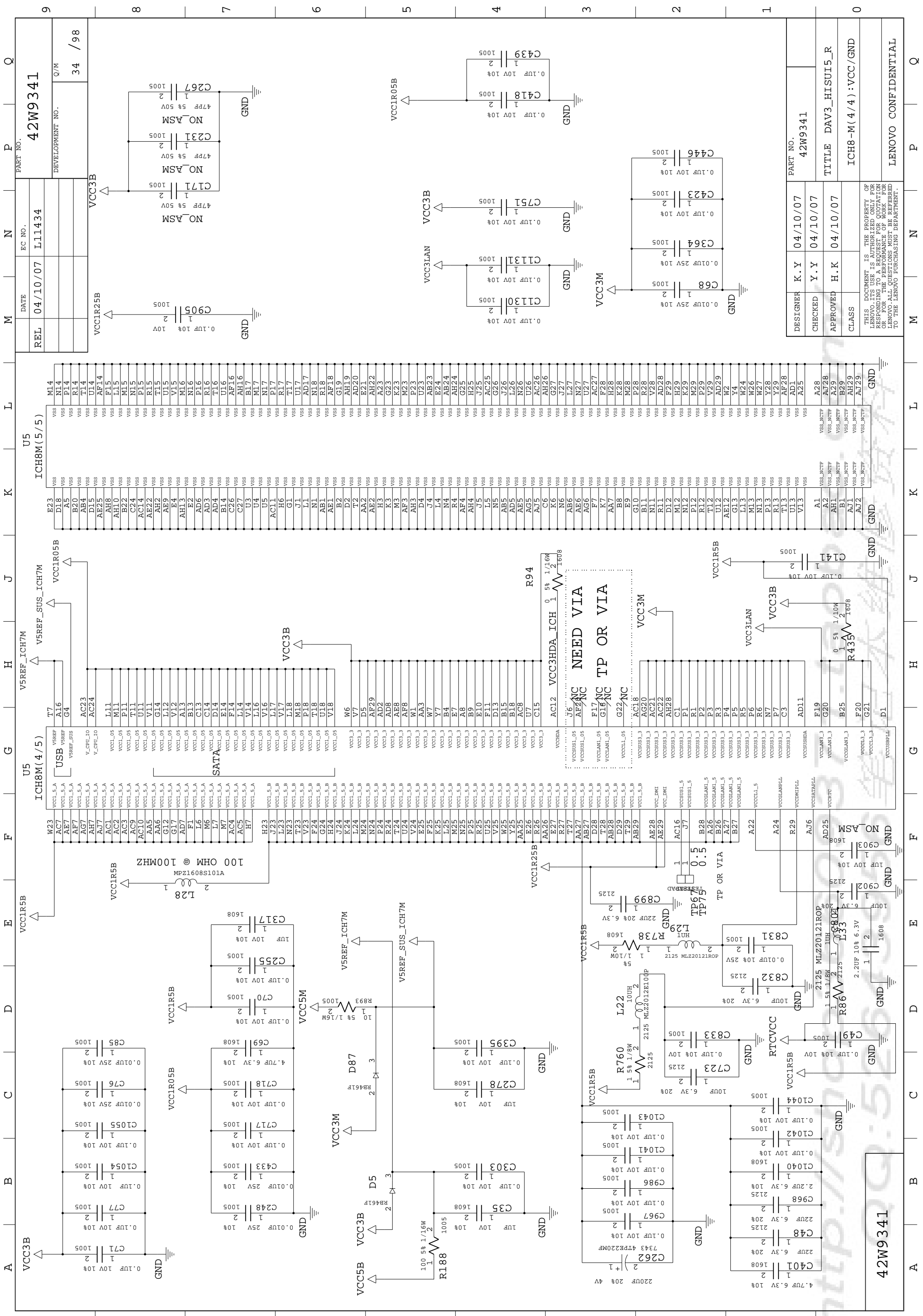

REL	DATE	EC NO.	PART NO.
04/10/07	L11434	42W9341	
		DEVELOPMENT NO.	34 / 98
			Q/M

DESIGNER	K. Y	04/10/07	PART NO.	42W9341
CHECKED	Y. Y	04/10/07	TITLE	DAV3_HISUI5_R
APPROVED	H. K	04/10/07	CLASS	ICH8-M(4/4):VCC/GND
THIS DOCUMENT IS THE PROPERTY OF LENOVO. IT IS LOANED TO YOU FOR USE ONLY. IT IS NOT TO BE REPRODUCED OR TRANSMITTED IN ANY FORM OR BY ANY MEANS, ELECTRONIC OR MECHANICAL, INCLUDING PHOTOCOPYING, RECORDING, OR BY ANY INFORMATION STORAGE AND RETRIEVAL SYSTEM. FOR MORE INFORMATION, CONTACT YOUR LENOVO ACCOUNT MANAGER OR THE LENOVO PURCHASING DEPARTMENT.				
LENOVO CONFIDENTIAL				



REL	DATE	EC NO.	PART NO.
REL	04/10/07	L11434	42W9341
			DEVELOPMENT NO.
			36 / 98

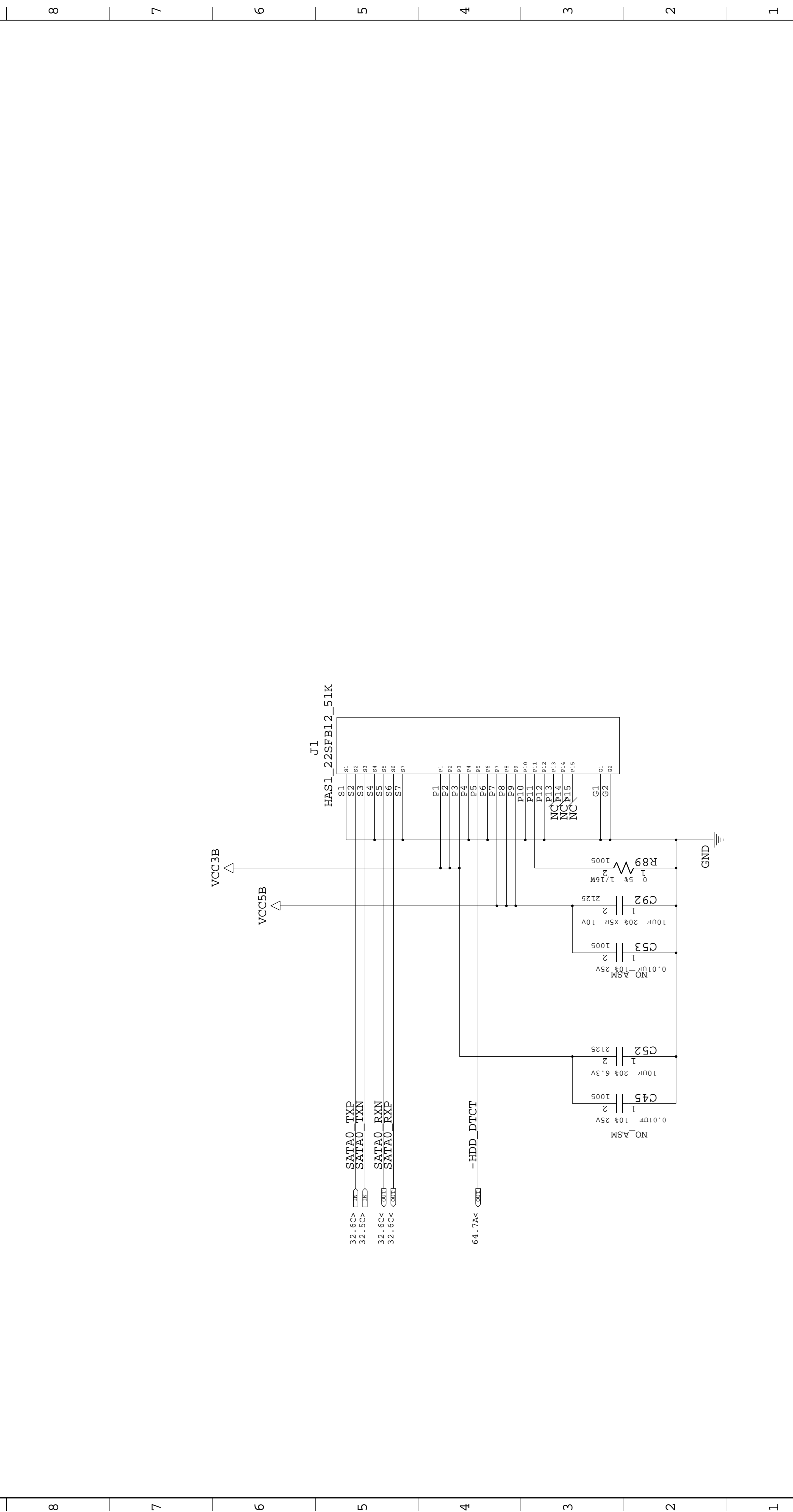

DESIGNER	K.Y	04/10/07	PART NO.
CHECKED	Y.Y	04/10/07	42W9341
APPROVED	H.K	04/10/07	TITLE DAV3_HISUI5_R
CLASS			SATA HDD CONN

THIS DOCUMENT IS THE PROPERTY OF LENOVO. IT IS LOANED TO YOU FOR USE ONLY. IT IS NOT TO BE REPRODUCED OR TRANSMITTED IN ANY FORM OR BY ANY MEANS, ELECTRONIC OR MECHANICAL, INCLUDING PHOTOCOPYING, RECORDING, OR BY ANY INFORMATION STORAGE AND RETRIEVAL SYSTEM. FOR MORE INFORMATION, CONTACT YOUR LENOVO PURCHASING DEPARTMENT. ALL QUESTIONS MUST BE REFERRED TO THE LENOVO PURCHASING DEPARTMENT.

42W9341

http://shop36609371.taobao.com 笔记本维修资料

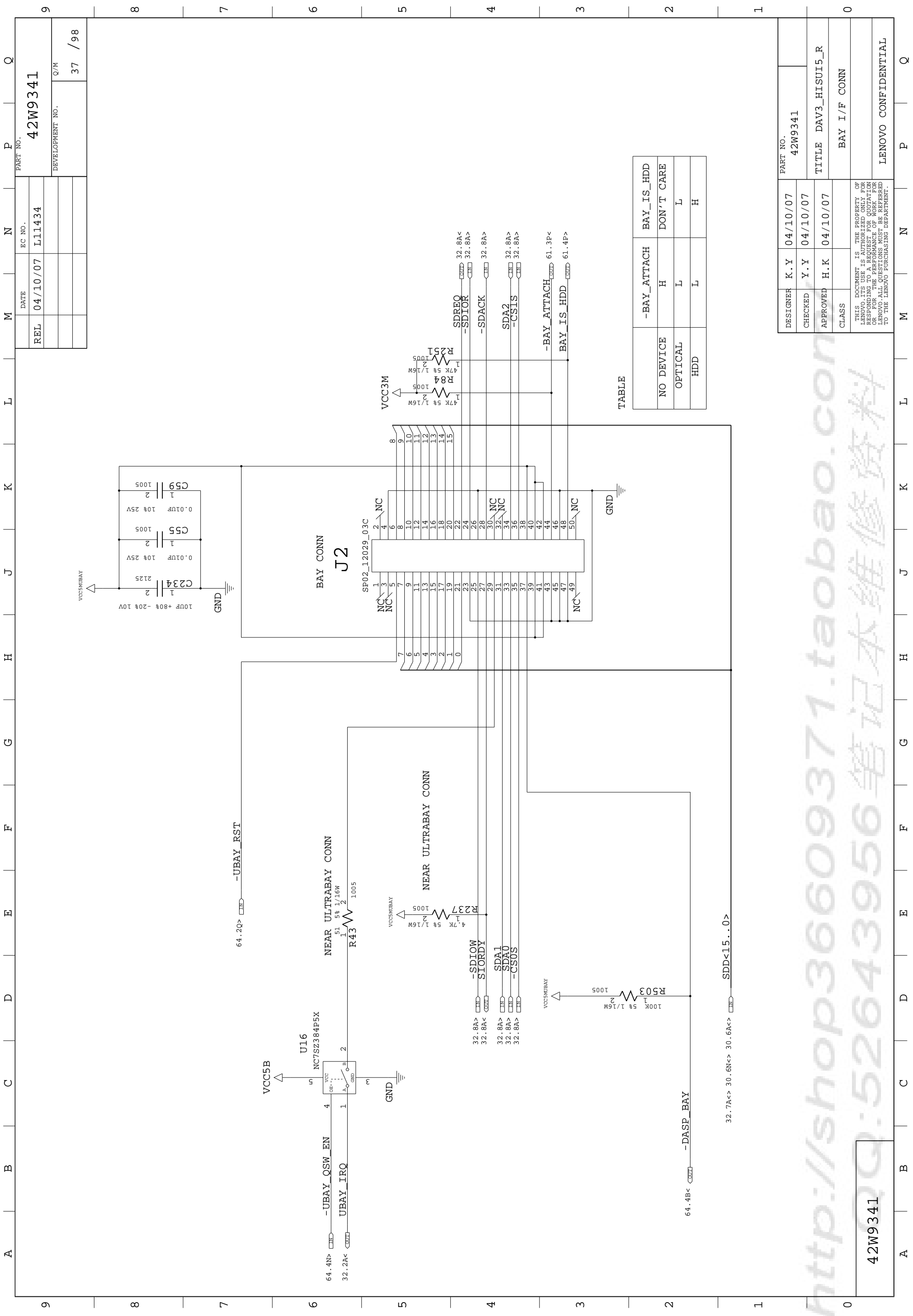

TABLE

NO DEVICE	-BAY_ATTACH	BAY_IS_HDD
OPTICAL	H	DON'T CARE
HDD	L	L
	L	H

DESIGNER	K.Y	04/10/07	PART NO.	42W9341
CHECKED	Y.Y	04/10/07	TITLE	DAV3_HISUI5_R
APPROVED	H.K	04/10/07	CLASS	BAY I/F CONN
<small>THIS DOCUMENT IS THE PROPERTY OF LENOVO. IT IS LOANED TO YOU FOR REVIEW ONLY. IT IS NOT TO BE REPRODUCED OR TRANSMITTED IN ANY FORM OR BY ANY MEANS, ELECTRONIC OR MECHANICAL, INCLUDING PHOTOCOPYING, RECORDING, OR BY ANY INFORMATION STORAGE AND RETRIEVAL SYSTEM. FOR MORE INFORMATION, CONTACT THE LENOVO PURCHASING DEPARTMENT.</small>				

42W9341

http://shop36609371.taobao.com 笔记本维修资料

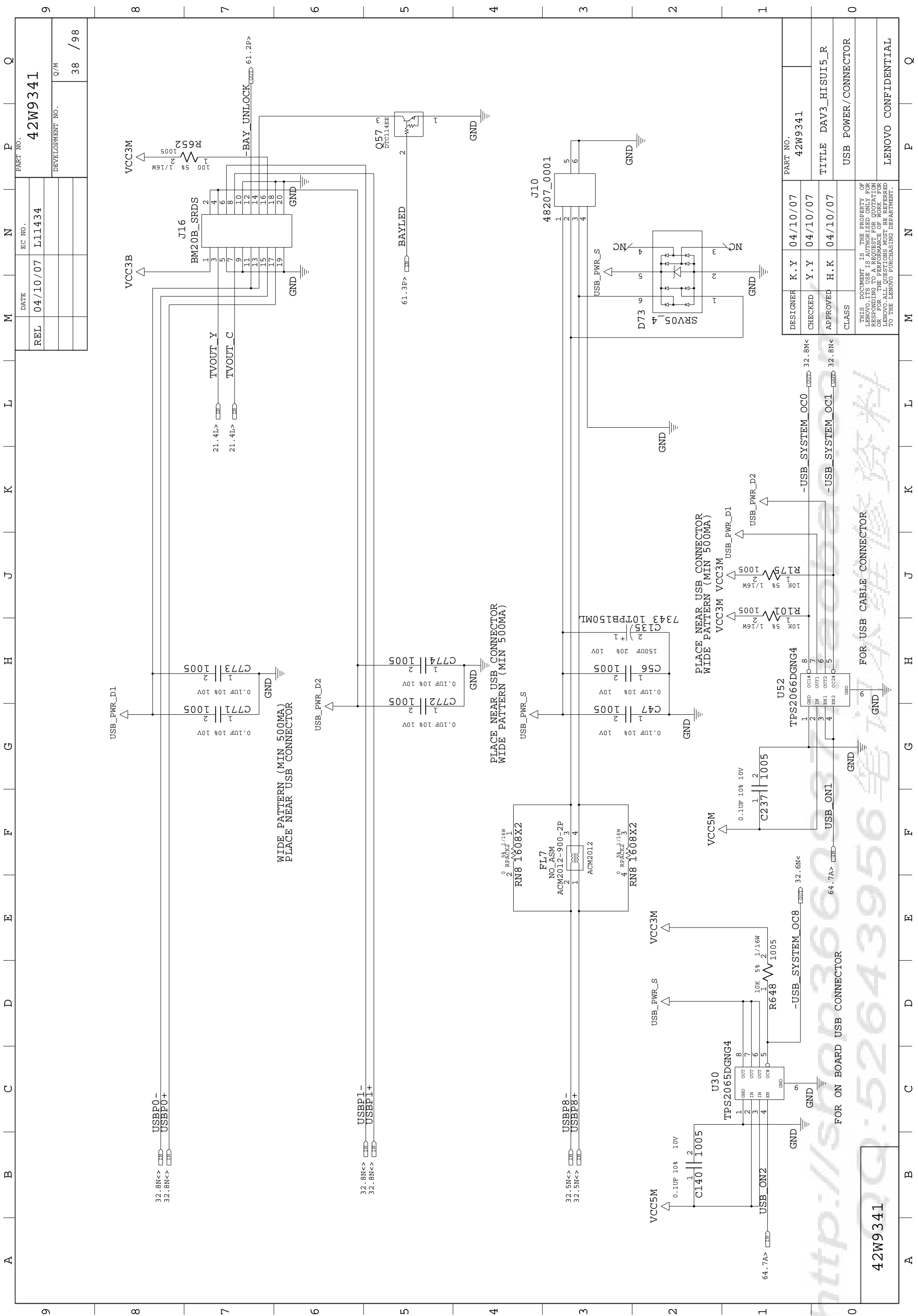

REL	04/10/07	EC NO.	L11434	PART NO.	42W9341
				DEVELOPMENT NO.	38 / 98

DESIGNER	K.Y	04/10/07	PART NO.	42W9341
CHECKED	Y.Y	04/10/07	TITLE	DAV3_HISUI5_R
APPROVED	H.K	04/10/07	CLASS	USB POWER/CONNECTOR
<p>THIS DOCUMENT IS THE PROPERTY OF LENOVO. IT IS LOANED TO YOU FOR USE ONLY. IT IS NOT TO BE REPRODUCED OR TRANSMITTED IN ANY FORM OR BY ANY MEANS, ELECTRONIC OR MECHANICAL, INCLUDING PHOTOCOPYING, RECORDING, OR BY ANY INFORMATION STORAGE AND RETRIEVAL SYSTEM. FOR MORE INFORMATION, CONTACT YOUR LENOVO ACCOUNT MANAGER OR THE LENOVO PURCHASING DEPARTMENT.</p>				

42W9341

FOR ON BOARD USB CONNECTOR

FOR USB CABLE CONNECTOR

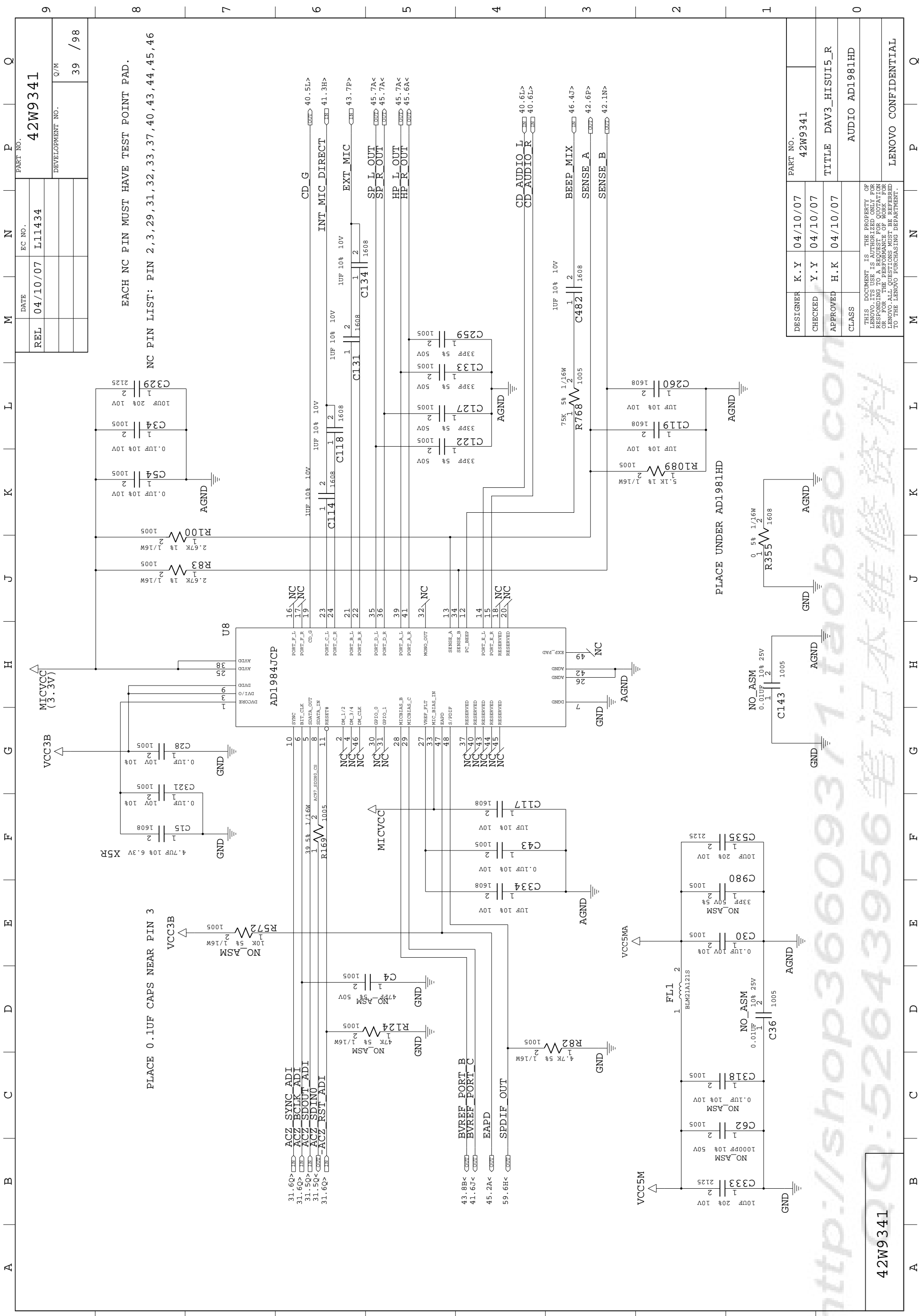

EACH NC PIN MUST HAVE TEST POINT PAD.

NC PIN LIST: PIN 2,3,29,31,32,33,37,40,43,44,45,46

PLACE 0.1UF CAPS NEAR PIN 3

PLACE UNDER AD1981HD

REL	04/10/07	L11434	42W9341
DATE	04/10/07	L11434	42W9341
EC NO.			
PART NO.			
DEVELOPMENT NO.			
Q/M			
			39 / 98

DESIGNER	K.Y	04/10/07	PART NO.	42W9341
CHECKED	Y.Y	04/10/07	TITLE	DAV3_HISUI5_R
APPROVED	H.K	04/10/07		AUDIO ADI1981HD
CLASS				

THIS DOCUMENT IS THE PROPERTY OF LENOVO. IT IS LOANED TO YOU FOR USE ONLY. IT IS NOT TO BE REPRODUCED OR TRANSMITTED IN ANY FORM OR BY ANY MEANS, ELECTRONIC OR MECHANICAL, INCLUDING PHOTOCOPYING, RECORDING, OR BY ANY INFORMATION STORAGE AND RETRIEVAL SYSTEM. FOR MORE INFORMATION, CONTACT THE LENOVO PURCHASING DEPARTMENT.

42W9341

http://shop36609371.taobao.com  
 52643956 笔记本维修资料





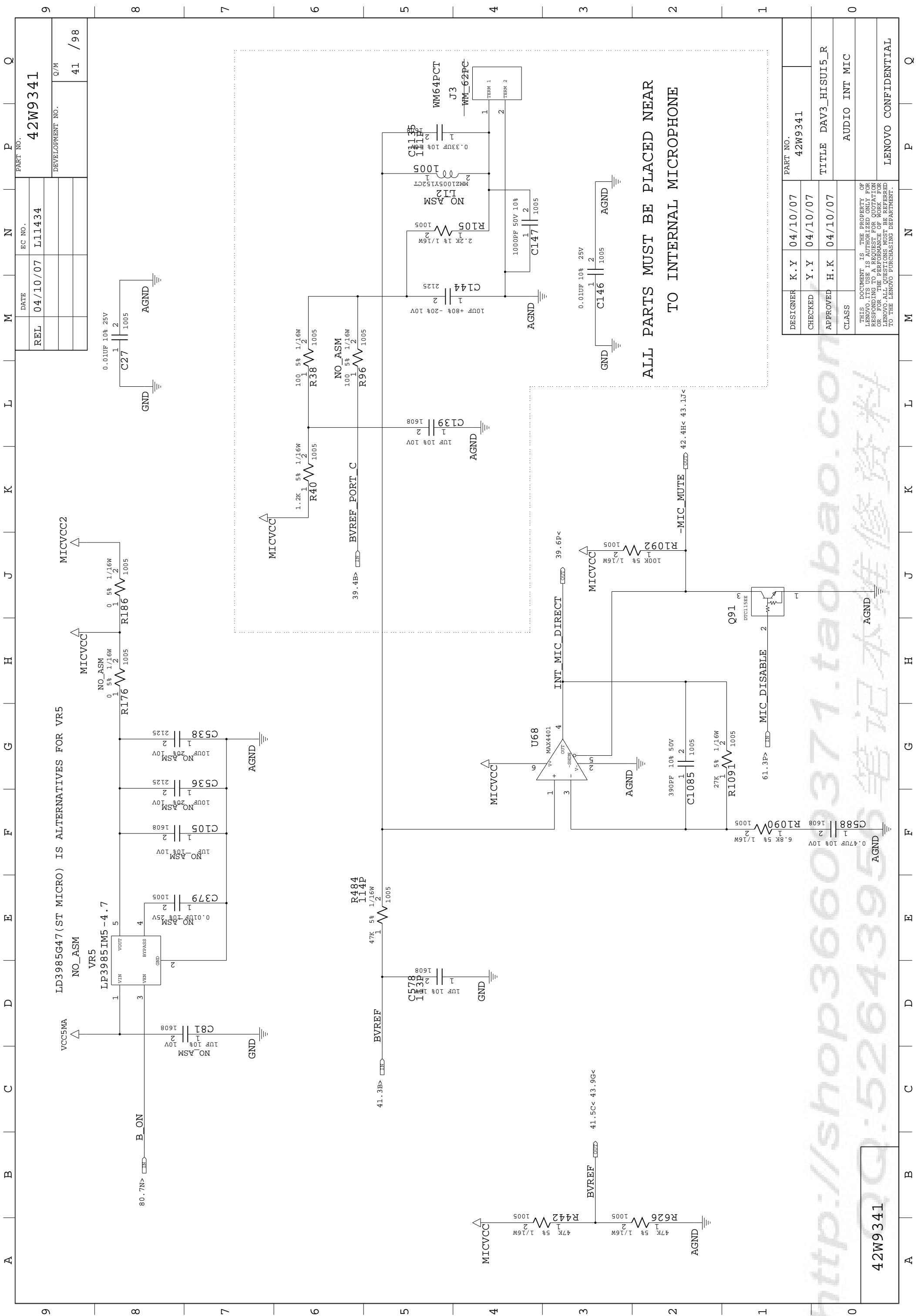

DESIGNER	K.Y	04/10/07	PART NO.	42W9341
CHECKED	Y.Y	04/10/07	TITLE	DAV3_HISUI5_R
APPROVED	H.K	04/10/07	CLASS	AUDIO INT MIC
THIS DOCUMENT IS THE PROPERTY OF LENOVO. IT IS LOANED TO YOU FOR USE ONLY. IT IS NOT TO BE REPRODUCED OR TRANSMITTED IN ANY FORM OR BY ANY MEANS, ELECTRONIC OR MECHANICAL, INCLUDING PHOTOCOPYING, RECORDING, OR BY ANY INFORMATION STORAGE AND RETRIEVAL SYSTEM. ALL RIGHTS ARE RESERVED. FOR MORE INFORMATION, CONTACT YOUR LENOVO PURCHASING DEPARTMENT.				

42W9341

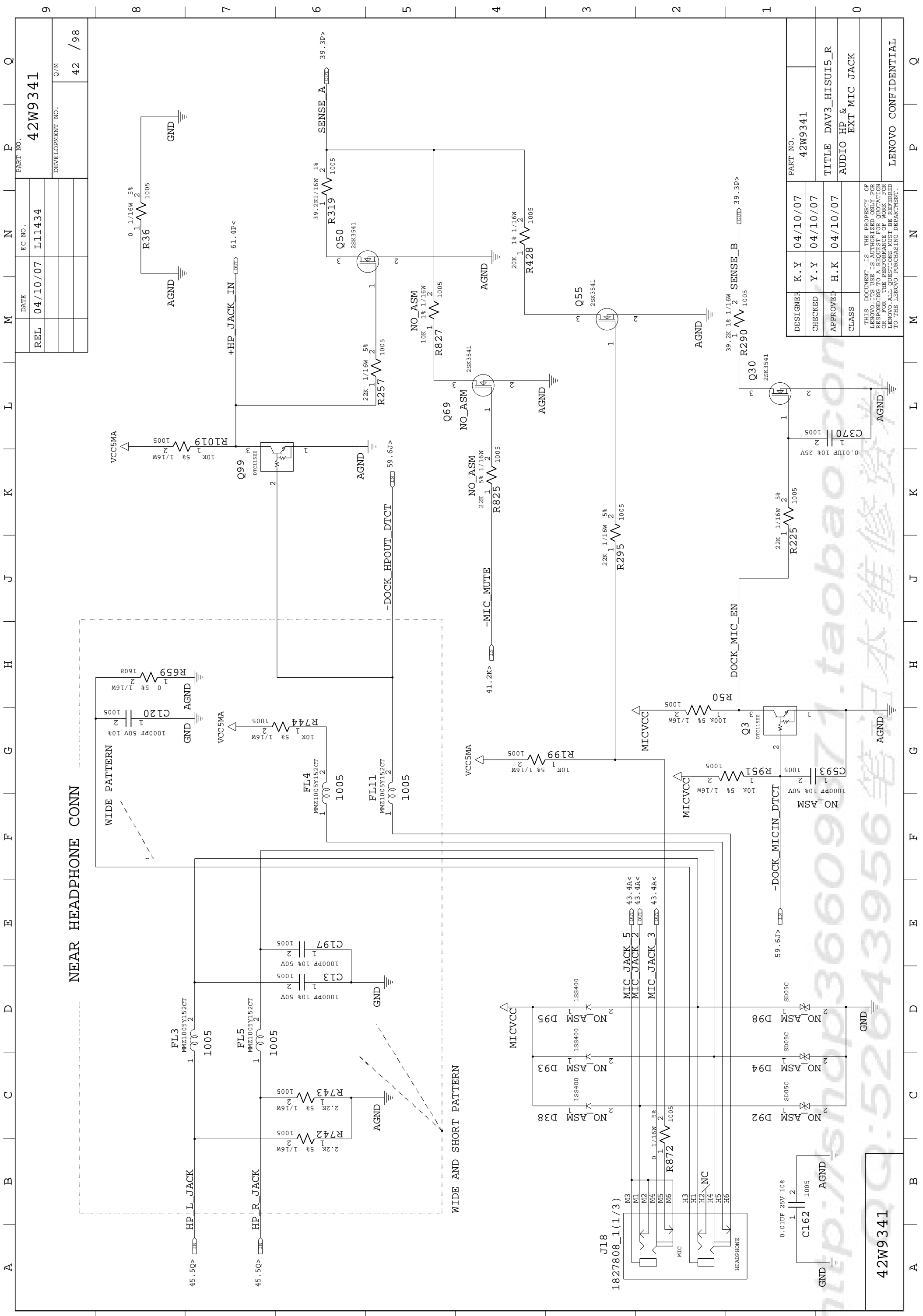

NEAR HEADPHONE CONN

REL	DATE	EC NO.	PART NO.
	04/10/07	L11434	42W9341
			DEVELOPMENT NO.
			Q/M
			42 / 98

DESIGNER	K.Y	04/10/07	PART NO.	42W9341
CHECKED	Y.Y	04/10/07	TITLE	DAV3_HISUI5_R
APPROVED	H.K	04/10/07	AUDIO	HP & EXT MIC JACK
CLASS				

42W9341

THIS DOCUMENT IS THE PROPERTY OF LENOVO. IT IS LOANED TO YOU FOR USE ONLY. IT IS NOT TO BE REPRODUCED OR TRANSMITTED IN ANY FORM OR BY ANY MEANS, ELECTRONIC OR MECHANICAL, INCLUDING PHOTOCOPYING, RECORDING, OR BY ANY INFORMATION STORAGE AND RETRIEVAL SYSTEM. FOR MORE INFORMATION, CONTACT YOUR LENOVO ACCOUNT MANAGER OR THE LENOVO PURCHASING DEPARTMENT.

LENOVO CONFIDENTIAL

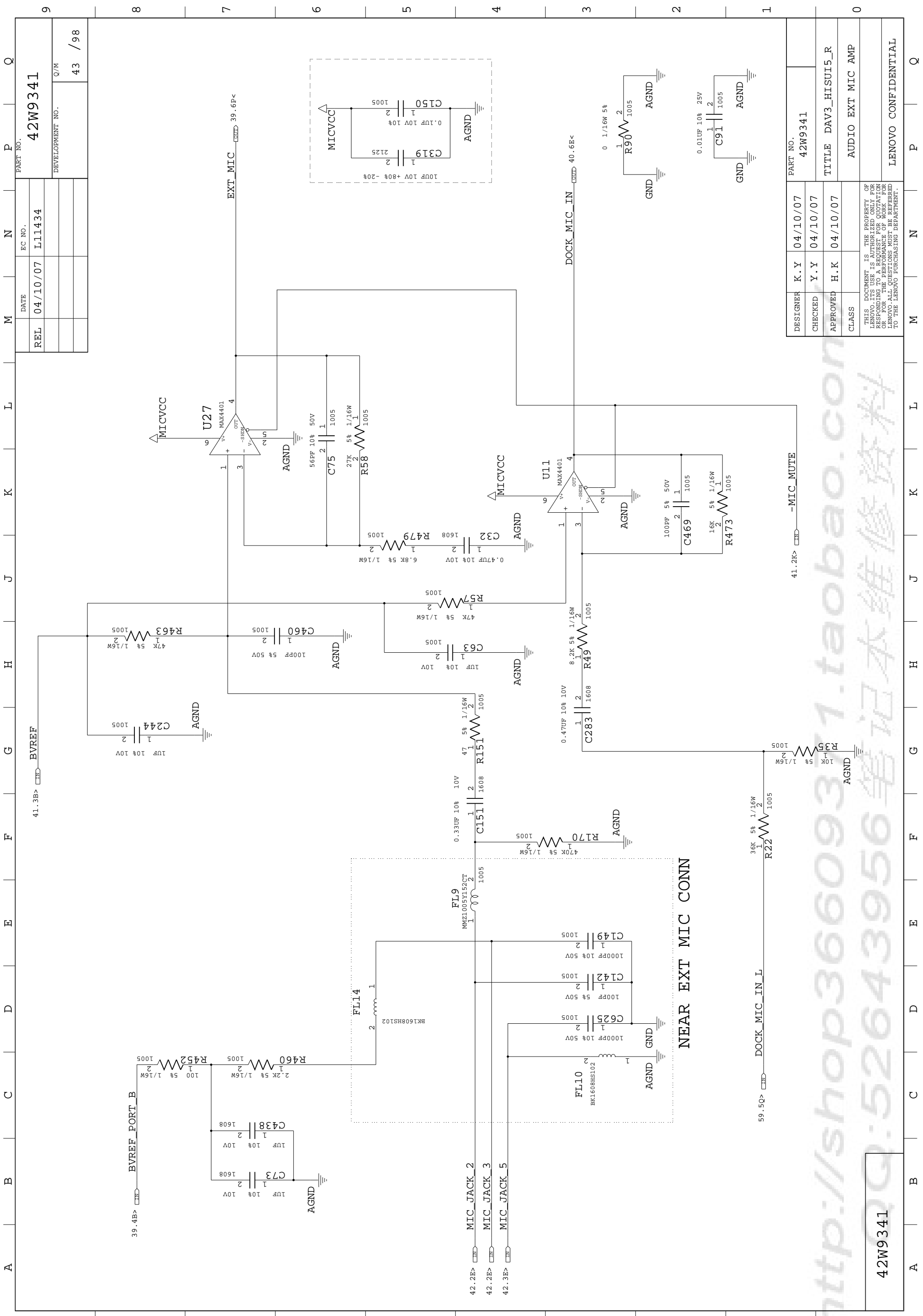

REL	04/10/07	EC NO.	L11434	PART NO.	42W9341
		DATE			
		DEVELOPMENT NO.			
					43 / 98

DESIGNER	K.Y	04/10/07	PART NO.	42W9341
CHECKED	Y.Y	04/10/07	TITLE	DAV3_HISUI5_R
APPROVED	H.K	04/10/07	CLASS	AUDIO EXT MIC AMP
THIS DOCUMENT IS THE PROPERTY OF LENOVO. IT IS LOANED TO YOU FOR YOUR USE ONLY. IT IS NOT TO BE REPRODUCED OR TRANSMITTED IN ANY FORM OR BY ANY MEANS, ELECTRONIC OR MECHANICAL, INCLUDING PHOTOCOPYING, RECORDING, OR BY ANY INFORMATION STORAGE AND RETRIEVAL SYSTEM. FOR MORE INFORMATION, CONTACT YOUR LENOVO ACCOUNT MANAGER OR THE LENOVO PURCHASING DEPARTMENT.				

http://shop36609371.taobao.com 笔记本维修资料

42W9341

REL	04/10/07	EC NO.	L11434	PART NO.	42W9341
		DATE			
				DEVELOPMENT NO.	44 / 98
				Q/M	

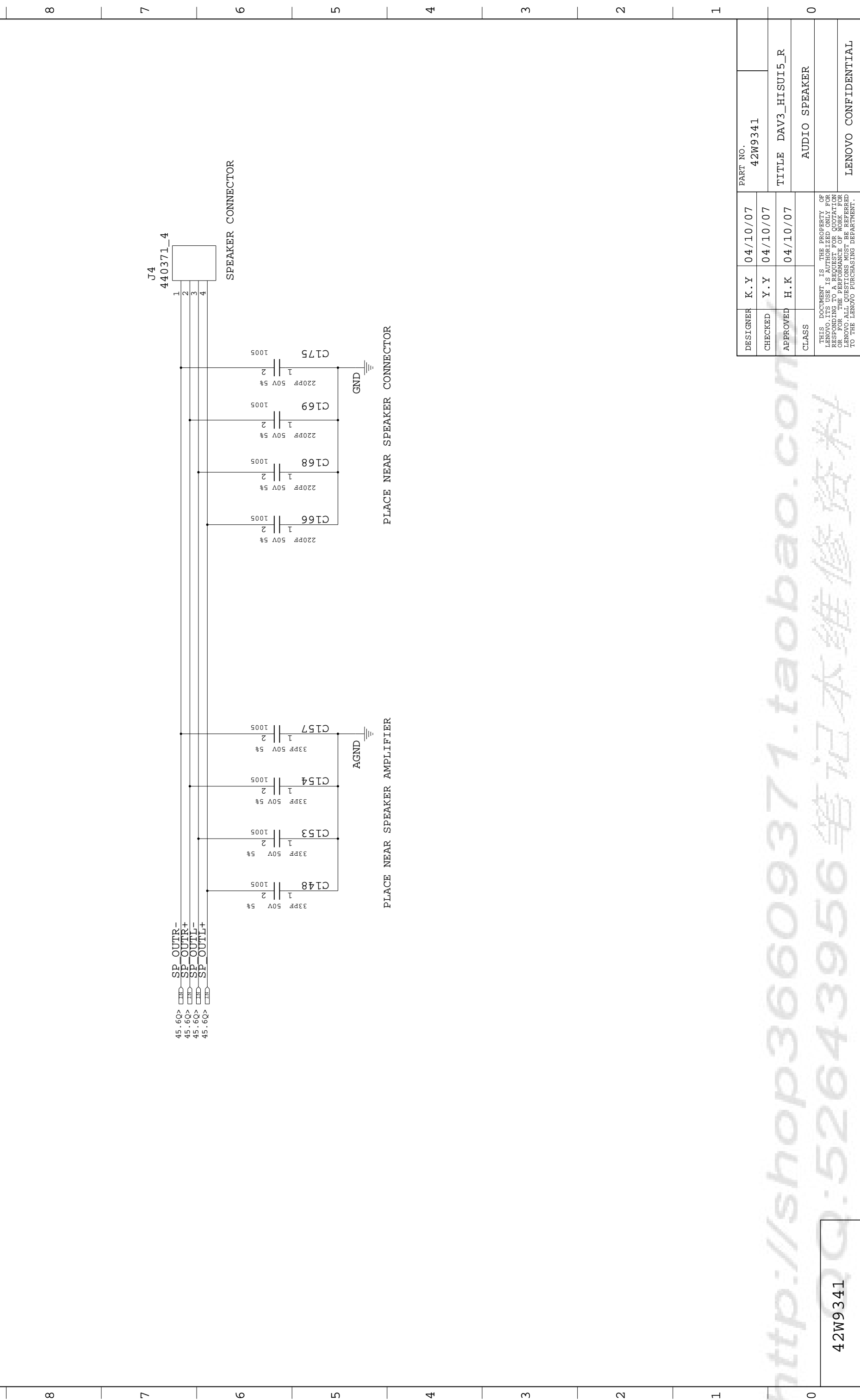

DESIGNER	K.Y	04/10/07	PART NO.	42W9341
CHECKED	Y.Y	04/10/07	TITLE	DAV3_HISUI5_R
APPROVED	H.K	04/10/07	CLASS	AUDIO SPEAKER
THIS DOCUMENT IS THE PROPERTY OF LENOVO. IT IS TO BE USED ONLY FOR THE PURPOSES SPECIFIED HEREIN. ANY REUSE OR DISTRIBUTION WITHOUT EXPRESS WRITTEN PERMISSION FROM LENOVO IS STRICTLY PROHIBITED. FOR MORE INFORMATION, CONTACT YOUR LENOVO ACCOUNT MANAGER OR REFER TO THE LENOVO CONFIDENTIALITY POLICY. ALL QUESTIONS MUST BE REFERRED TO THE LENOVO PURCHASING DEPARTMENT.				
LENOVO CONFIDENTIAL				

http://shop36609371.taobao.com 笔记本维修资料



REL	04/10/07	L11434	42W9341
DATE	04/10/07	L11434	42W9341
EC NO.			
PART NO.			
DEVELOPMENT NO.			
Q/M			
			46 / 98

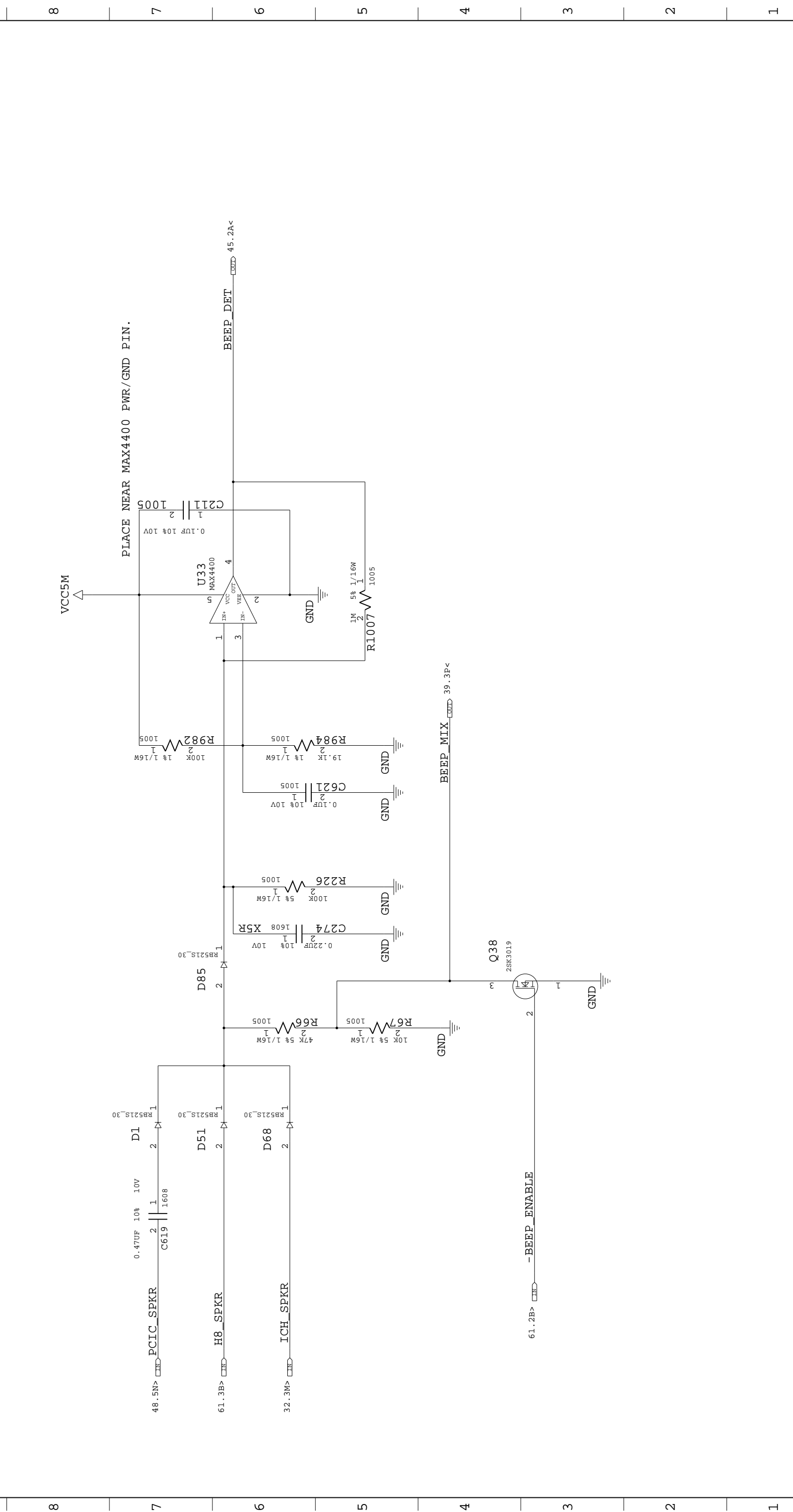

DESIGNER	K.Y	04/10/07	PART NO.	42W9341
CHECKED	Y.Y	04/10/07	TITLE	DAV3_HISUI5_R
APPROVED	H.K	04/10/07	CLASS	AUDIO HDP AMP MISC
THIS DOCUMENT IS THE PROPERTY OF LENOVO. IT IS LOANED TO YOU FOR YOUR USE ONLY. IT IS NOT TO BE REPRODUCED OR TRANSMITTED IN ANY FORM OR BY ANY MEANS, ELECTRONIC OR MECHANICAL, INCLUDING PHOTOCOPYING, RECORDING, OR BY ANY INFORMATION STORAGE AND RETRIEVAL SYSTEM. WITHOUT PERMISSION IN WRITING FROM LENOVO, ALL QUESTIONS MUST BE REFERRED TO THE LENOVO PURCHASING DEPARTMENT.				
LENOVO CONFIDENTIAL				

http://shop36609371.taobao.com 笔记本维修资料

42W9341

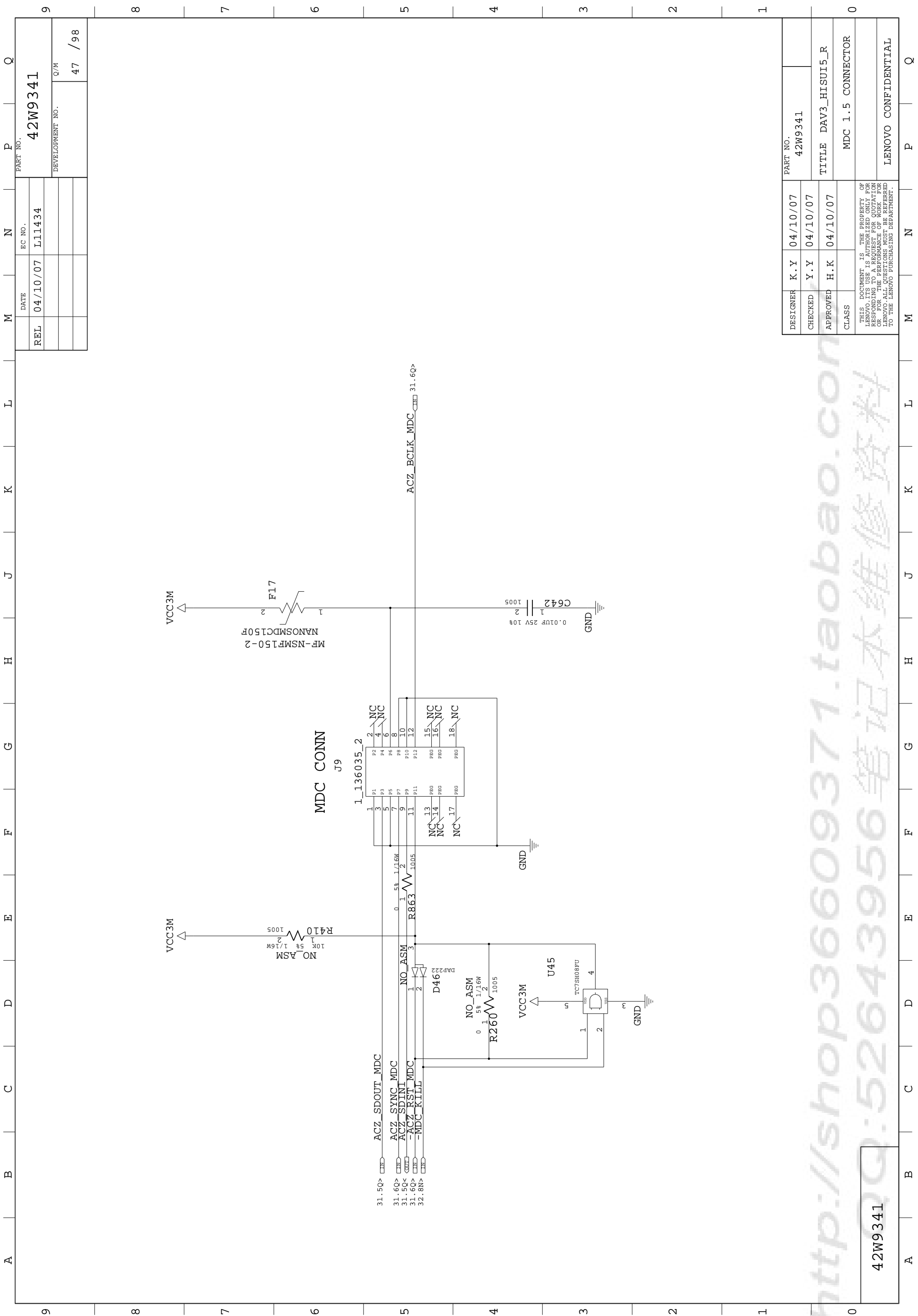

REL	DATE	EC NO.	PART NO.
	04/10/07	L11434	42W9341
			DEVELOPMENT NO.
			47 / 98

DESIGNER	K.Y	04/10/07	PART NO.	42W9341
CHECKED	Y.Y	04/10/07	TITLE	DAV3_HISUI5_R
APPROVED	H.K	04/10/07	CLASS	MDC 1.5 CONNECTOR
THIS DOCUMENT IS THE PROPERTY OF LENOVO. IT IS LOANED TO YOU FOR REVIEW ONLY. IT IS NOT TO BE REPRODUCED OR TRANSMITTED IN ANY FORM OR BY ANY MEANS, ELECTRONIC OR MECHANICAL, INCLUDING PHOTOCOPYING, RECORDING, OR BY ANY INFORMATION STORAGE AND RETRIEVAL SYSTEM. ALL RIGHTS ARE RESERVED. FOR MORE INFORMATION, CONTACT THE LENOVO PURCHASING DEPARTMENT.				
LENOVO CONFIDENTIAL				

http://shop36609371.taobao.com 笔记本维修资料

42W9341

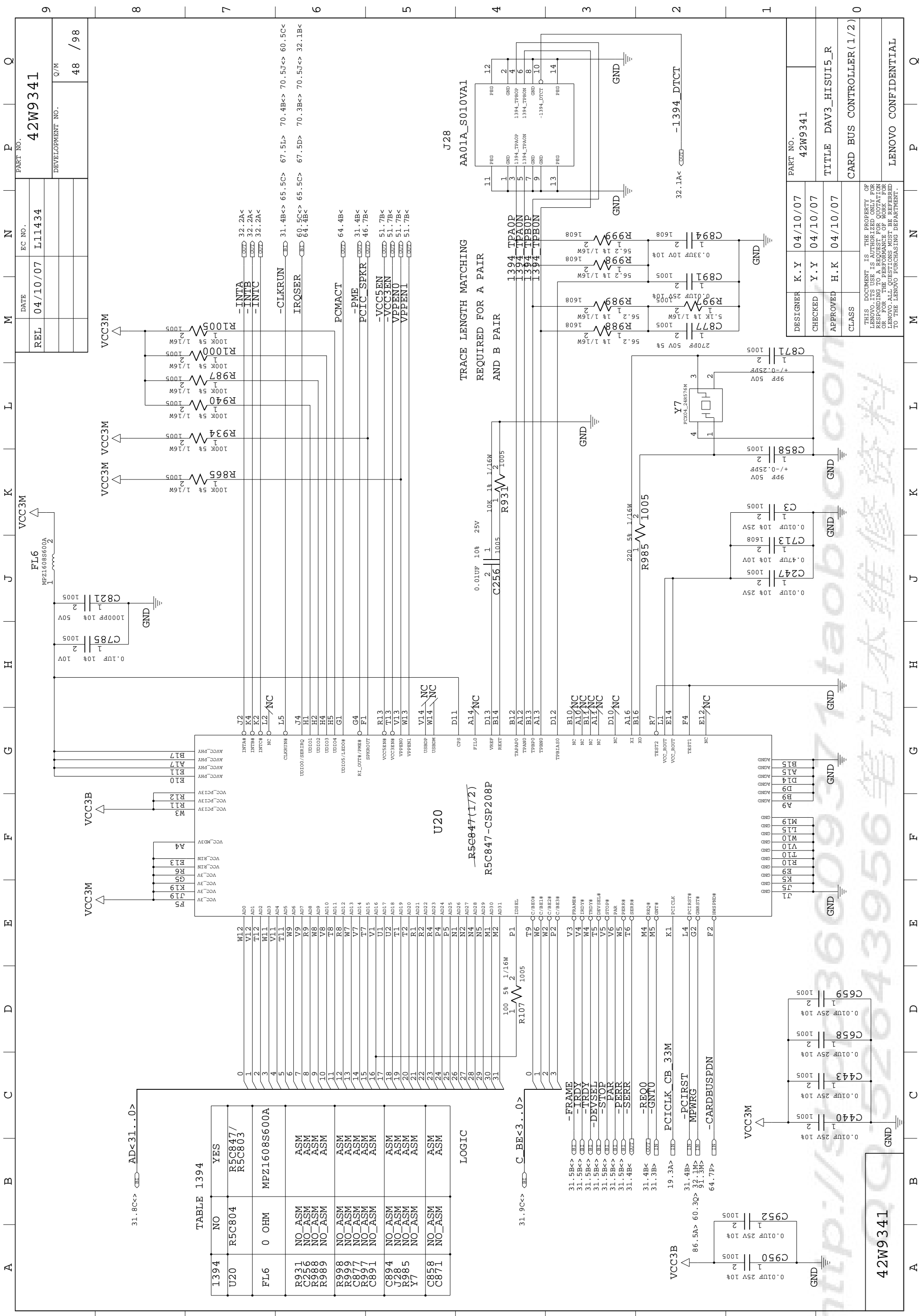

DESIGNER	K.Y	04/10/07	PART NO.	42W9341
CHECKED	Y.Y	04/10/07	TITLE	DAV3_HISUI5_R
APPROVED	H.K	04/10/07	CLASS	CARD BUS CONTROLLER(1/2)

42W9341

LENOVO CONFIDENTIAL





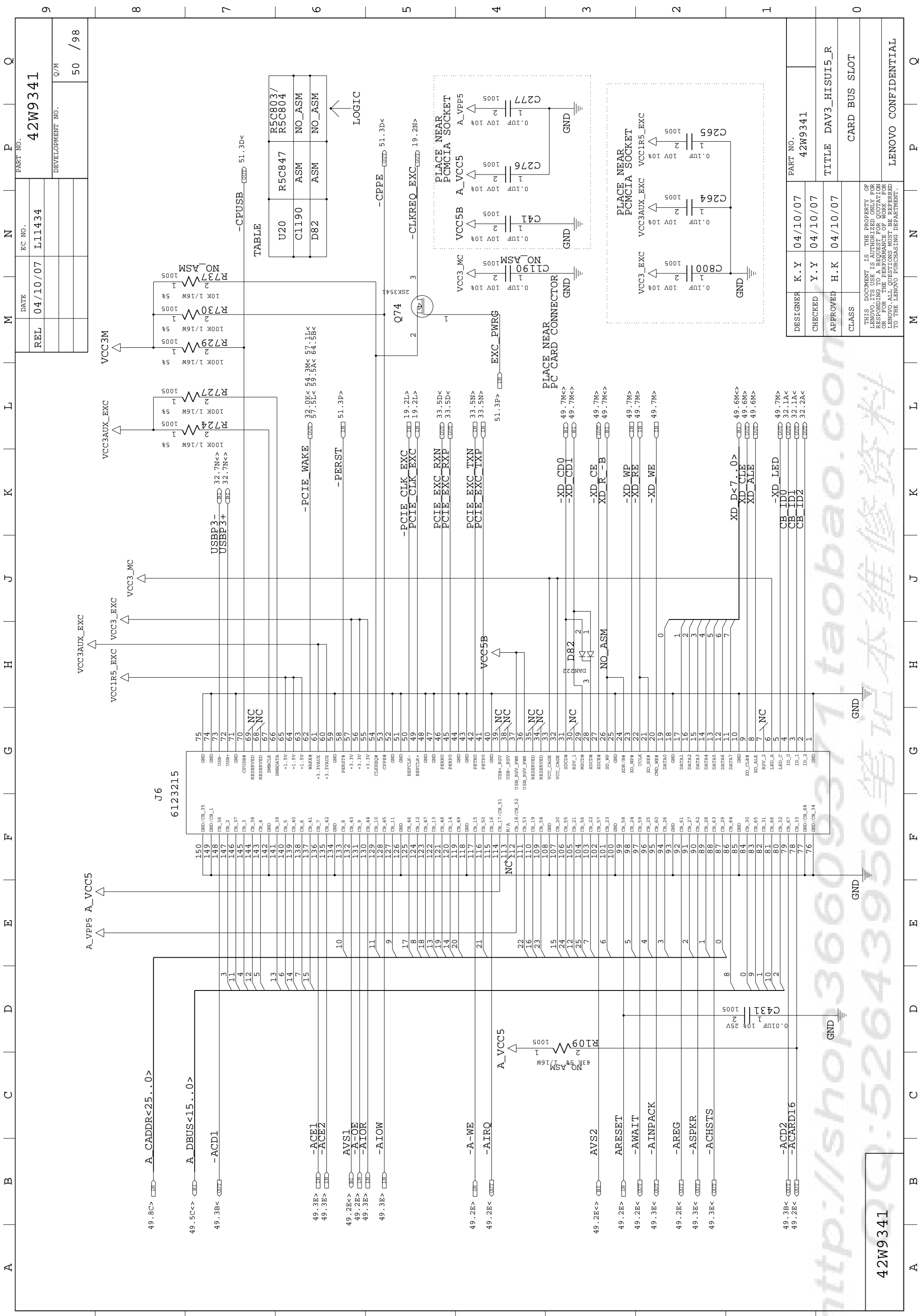

http://shop36609371.taobao.com 笔记本维修资料

LENOVO CONFIDENTIAL

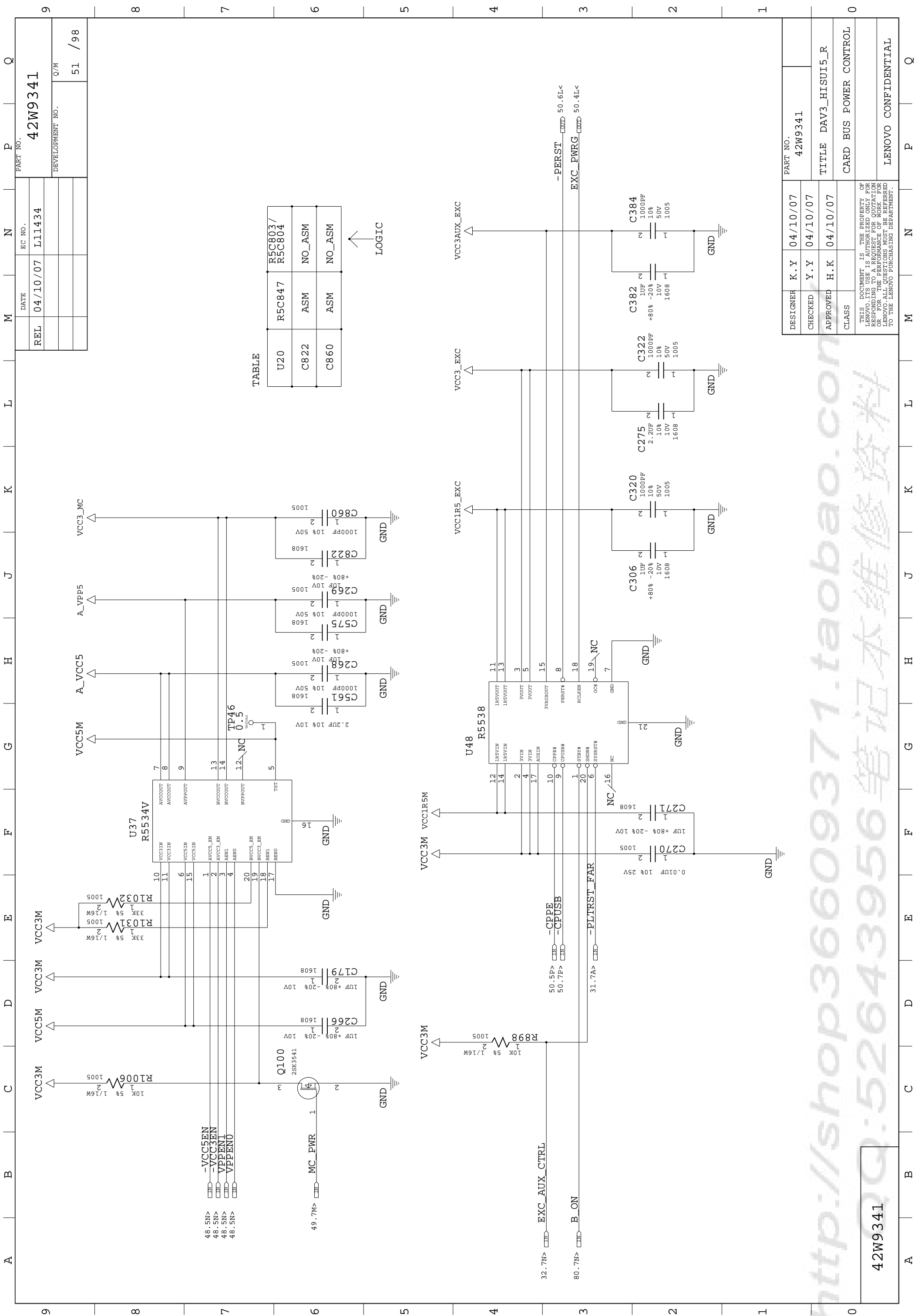

DESIGNER	K.Y	04/10/07	PART NO.	42W9341
CHECKED	Y.Y	04/10/07	TITLE	DAV3_HISUI5_R
APPROVED	H.K	04/10/07	CLASS	CARD BUS POWER CONTROL
THIS DOCUMENT IS THE PROPERTY OF LENOVO. IT IS TO BE USED ONLY FOR THE PURPOSES SPECIFIED HEREIN. ANY REUSE OR DISTRIBUTION OF THIS DOCUMENT WITHOUT THE WRITTEN PERMISSION OF LENOVO IS STRICTLY PROHIBITED. ALL QUESTIONS MUST BE REFERRED TO THE LENOVO PURCHASING DEPARTMENT.				

http://shop36609371.taobao.com 笔记本维修资料

42W9341

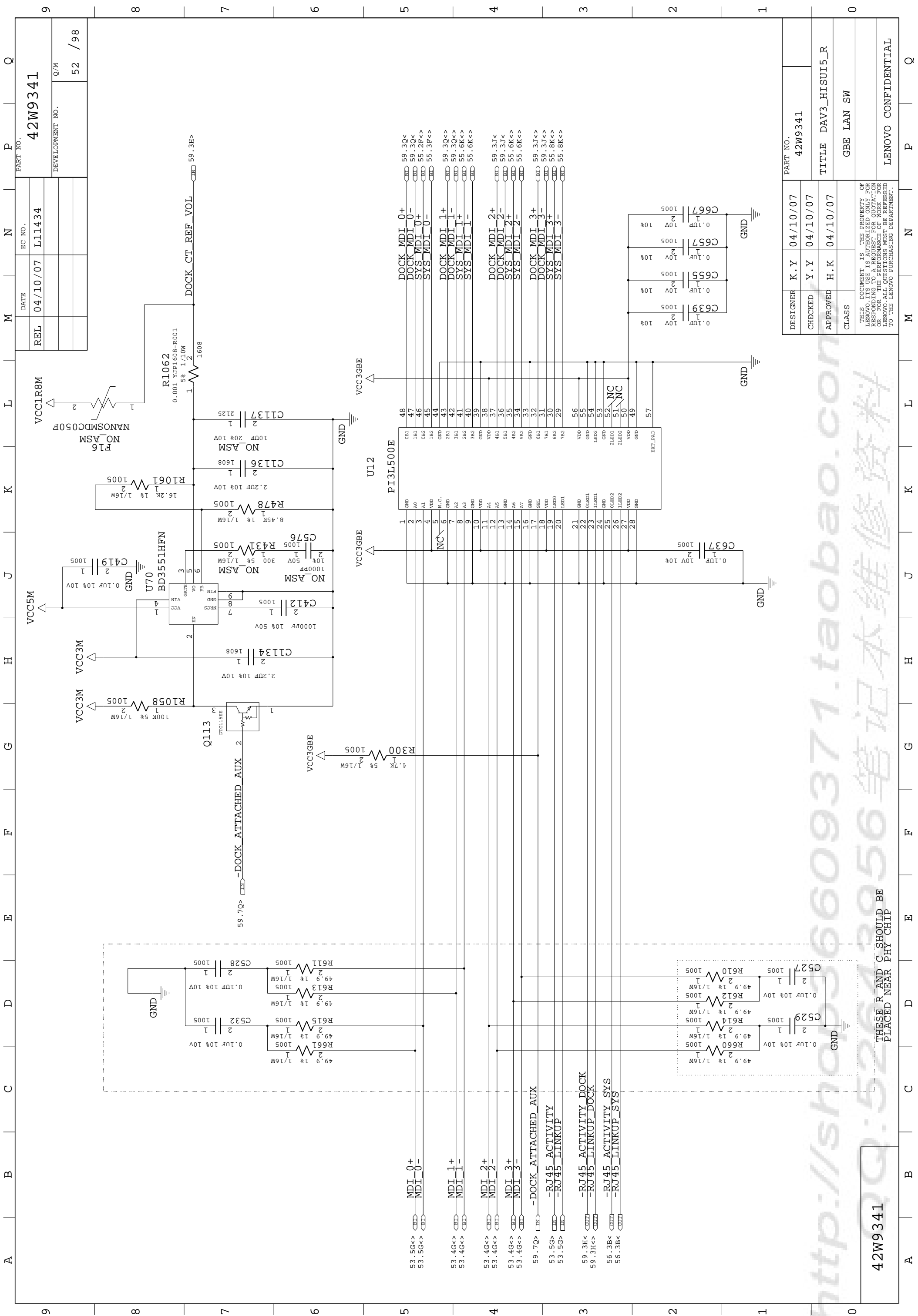

REL	DATE	EC NO.	PART NO.
	04/10/07	L11434	42W9341
			DEVELOPMENT NO.
			52 / 98

DESIGNER	K. Y	04/10/07	PART NO.
CHECKED	Y. Y	04/10/07	42W9341
APPROVED	H. K	04/10/07	TITLE
CLASS			DAV3_HISUI5_R
			GBE LAN SW

42W9341

THESE R AND C SHOULD BE PLACED NEAR PHY CHIP

http://shop36609371.taobao.com 笔记本维修资料

THIS DOCUMENT IS THE PROPERTY OF LENOVO. IT IS LOANED TO YOU FOR USE ONLY. IT IS NOT TO BE REPRODUCED OR TRANSMITTED IN ANY FORM OR BY ANY MEANS, ELECTRONIC OR MECHANICAL, INCLUDING PHOTOCOPYING, RECORDING, OR BY ANY INFORMATION STORAGE AND RETRIEVAL SYSTEM. FOR MORE INFORMATION, CONTACT THE LENOVO PURCHASING DEPARTMENT.

LENOVO CONFIDENTIAL

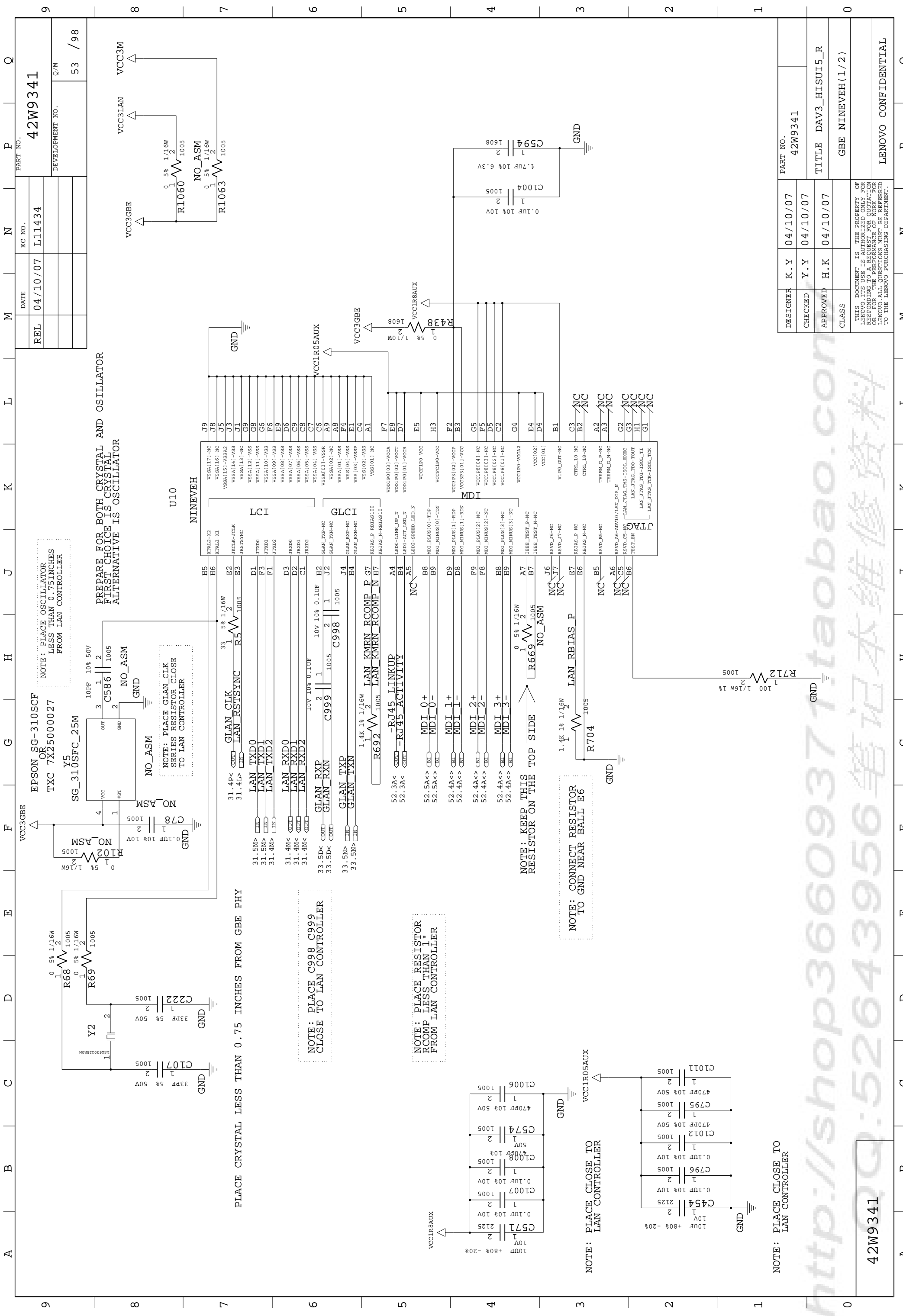

REL	04/10/07	L11434	DATE	EC NO.	42W9341
				DEVELOPMENT NO.	53 / 98
					Q/M

DESIGNER	K. Y	04/10/07	PART NO.	42W9341
CHECKED	Y. Y	04/10/07	TITLE	DAV3_HISUI5_R
APPROVED	H. K	04/10/07	CLASS	GBE NINEVEH(1/2)
				THIS DOCUMENT IS THE PROPERTY OF
				LENOVO. ALL RIGHTS RESERVED. NO PARTS
				OR FOR THE PERFORMANCE OF WORK FOR
				LENOVO. ALL QUESTIONS MUST BE REFERRED
				TO THE LENOVO PURCHASING DEPARTMENT.



42W9341

9	8	7	6	5	4	3	2	1	0
A	B	C	D	E	F	G	H	J	K
M	L								
N									
P									
Q									

# MICRO PCIE CONN

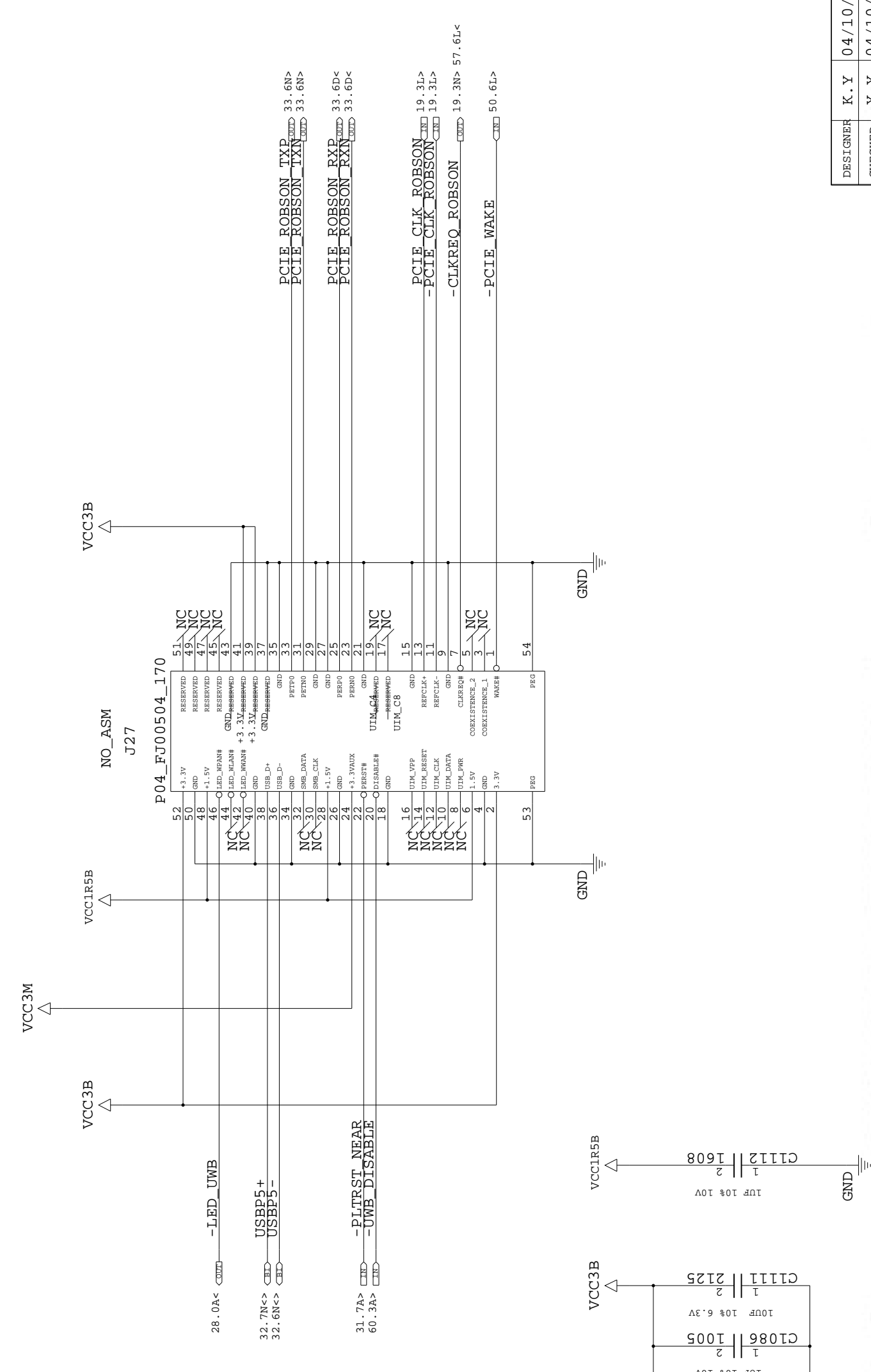

http://shop36609371.taobao.com 笔记本维修资料

DESIGNER	K.Y	04/10/07	PART NO.	42W9341
CHECKED	Y.Y	04/10/07	TITLE	DAV3_HISUI5_R
APPROVED	H.K	04/10/07	CLASS	MICRO PCIE CONN
THIS DOCUMENT IS THE PROPERTY OF LENOVO. IT IS TO BE USED ONLY FOR THE PURPOSES SPECIFIED HEREIN. ANY REPRODUCTION OR TRANSMISSION OF THIS DOCUMENT WITHOUT THE WRITTEN PERMISSION OF LENOVO IS STRICTLY PROHIBITED. FOR MORE INFORMATION, CONTACT YOUR LENOVO ACCOUNT MANAGER OR THE LENOVO PURCHASING DEPARTMENT.				

42W9341

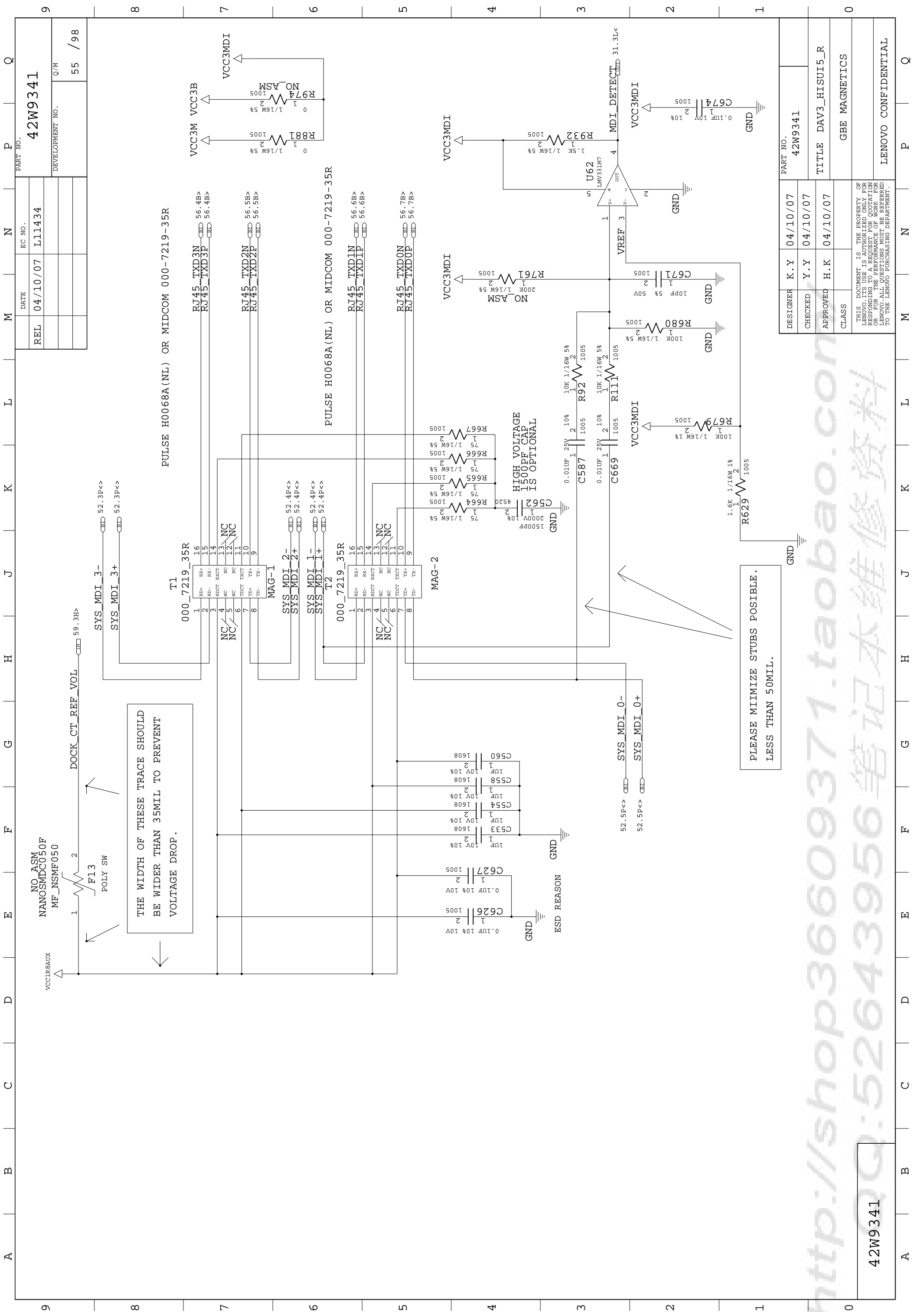

NO\_ASM  
NANOSMDC050F  
MF\_NSMF050

THE WIDTH OF THESE TRACE SHOULD BE WIDER THAN 35MIL TO PREVENT VOLTAGE DROP.

PLEASE MINIMIZE STUBS POSSIBLE. LESS THAN 50MIL.

http://shop36609371.taobao.com 笔记本维修资料

REL	DATE	EC NO.	PART NO.
	04/10/07	L11434	42W9341
			DEVELOPMENT NO.
			55 / 98

DESIGNER	K.Y	04/10/07	PART NO.	42W9341
CHECKED	Y.Y	04/10/07	TITLE	DAV3_HISUI5_R
APPROVED	H.K	04/10/07	CLASS	GBE MAGNETICS
THIS DOCUMENT IS THE PROPERTY OF GBE MAGNETICS. IT IS TO BE USED ONLY FOR THE PURPOSES SPECIFIED IN THE TITLE. ANY REUSE OR REPRODUCTION WITHOUT THE WRITTEN PERMISSION OF GBE MAGNETICS IS STRICTLY PROHIBITED. ALL QUESTIONS MUST BE REFERRED TO THE LENOVO PURCHASING DEPARTMENT.				
				LENOVO CONFIDENTIAL

REL	DATE	EC NO.	PART NO.
04/10/07	L11434	42W9341	
			DEVELOPMENT NO.
			56 / 98

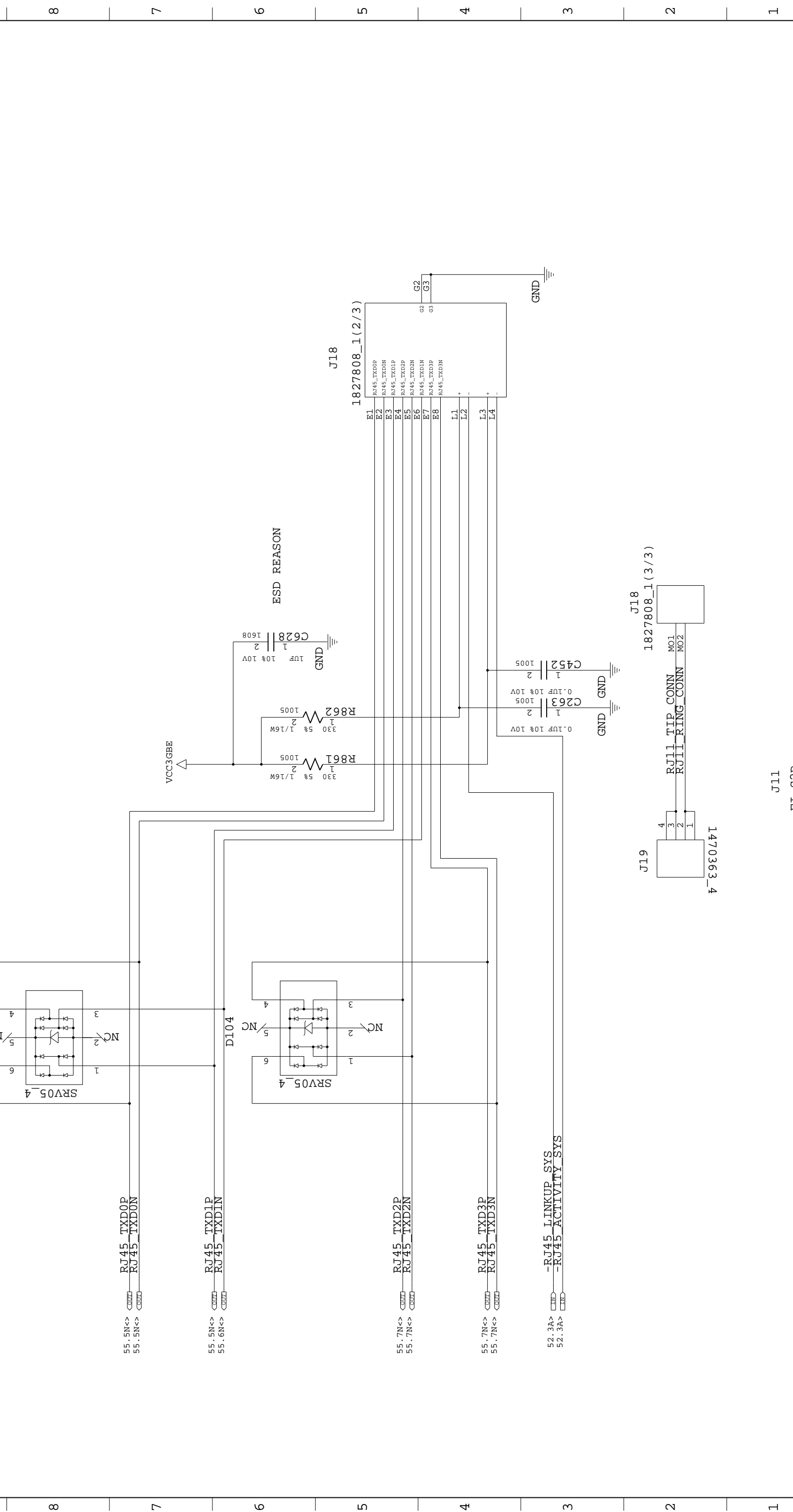

DESIGNER	K. Y	04/10/07	PART NO.	42W9341
CHECKED	Y. Y	04/10/07	TITLE	DAV3_HISUI5_R
APPROVED	H. K	04/10/07		
CLASS				RJ11/RJ45 CONNECTOR
THIS DOCUMENT IS THE PROPERTY OF LENOVO. IT IS LOANED TO YOU FOR USE ONLY. IT IS NOT TO BE REPRODUCED OR TRANSMITTED IN ANY FORM OR BY ANY MEANS, ELECTRONIC OR MECHANICAL, INCLUDING PHOTOCOPYING, RECORDING, OR BY ANY INFORMATION STORAGE AND RETRIEVAL SYSTEM. ALL RIGHTS RESERVED. FOR MORE INFORMATION, CONTACT YOUR LENOVO PURCHASING DEPARTMENT.				

http://shop36609371.taobao.com 笔记本维修资料

42W9341



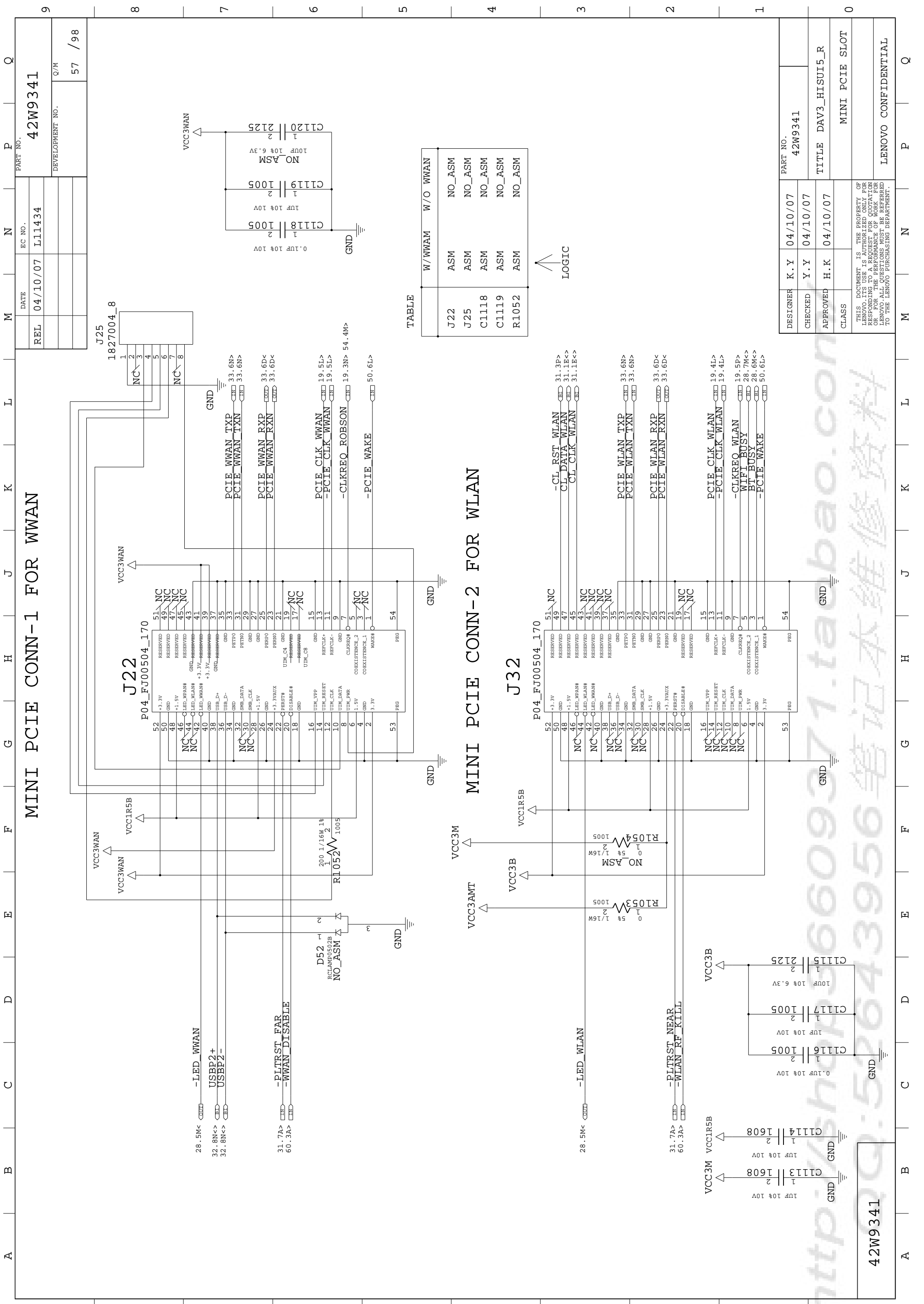

MINI PCIE CONN-1 FOR WWAN

MINI PCIE CONN-2 FOR WLAN

TABLE

	W/WWAM	W/O WWAN
J22	ASM	NO_ASM
J25	ASM	NO_ASM
C1118	ASM	NO_ASM
C1119	ASM	NO_ASM
R1052	ASM	NO_ASM

LOGIC

DESIGNER	K.Y	04/10/07	PART NO.	42W9341
CHECKED	Y.Y	04/10/07	TITLE	DAV3_HISUI5_R
APPROVED	H.K	04/10/07		MINI PCIE SLOT
CLASS				

THIS DOCUMENT IS THE PROPERTY OF LENOVO. IT IS LOANED TO YOU FOR USE ONLY. IT IS NOT TO BE REPRODUCED OR TRANSMITTED IN ANY FORM OR BY ANY MEANS, ELECTRONIC OR MECHANICAL, INCLUDING PHOTOCOPYING, RECORDING, OR BY ANY INFORMATION STORAGE AND RETRIEVAL SYSTEM. FOR MORE INFORMATION, CONTACT YOUR LENOVO ACCOUNT MANAGER OR THE LENOVO PURCHASING DEPARTMENT.

42W9341

http://shop36609371.taobao.com 笔记本维修资料

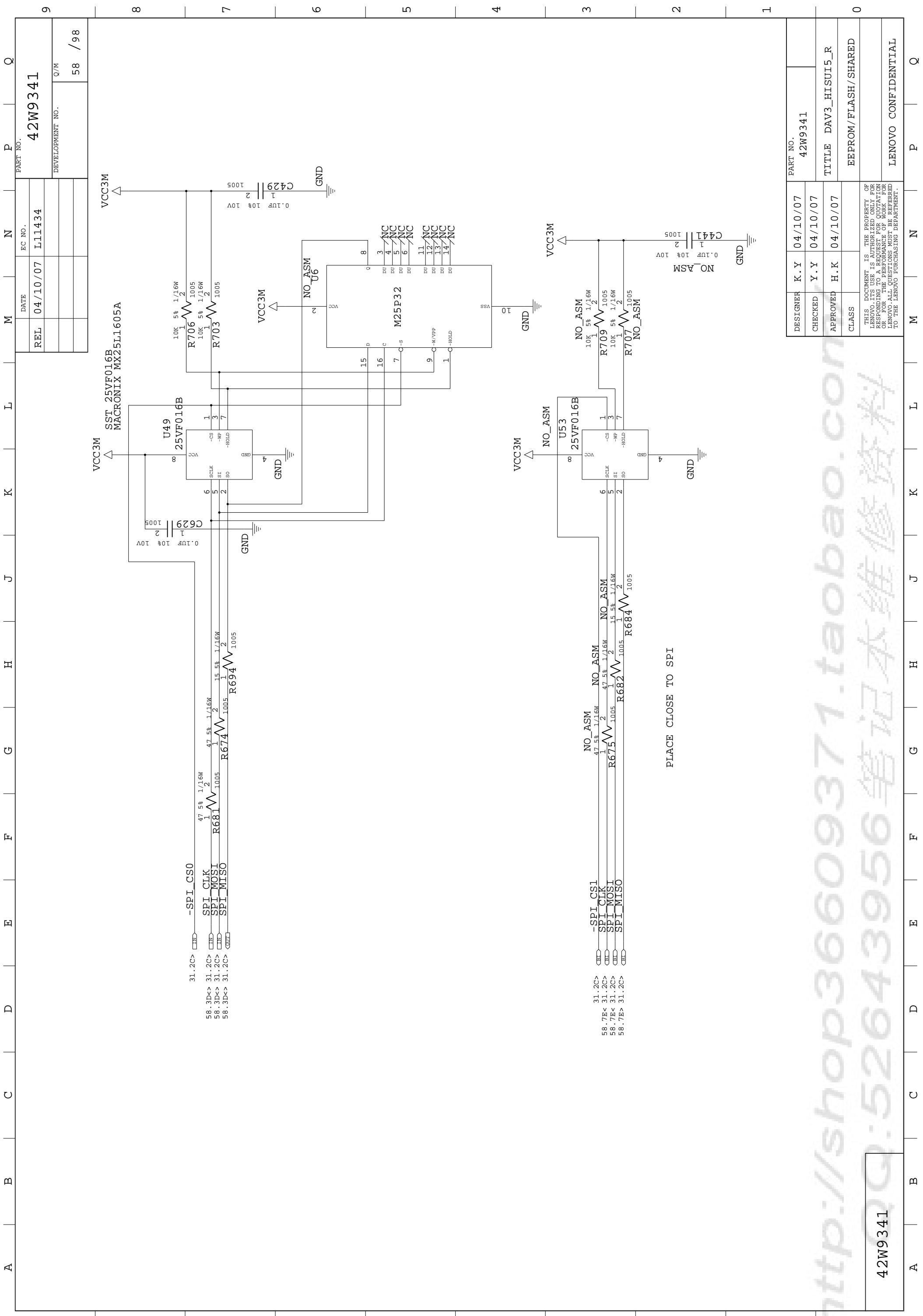

DESIGNER	K.Y	04/10/07	PART NO.	42W9341
CHECKED	Y.Y	04/10/07	TITLE	DAV3_HISUI5_R
APPROVED	H.K	04/10/07	CLASS	EEPROM/FLASH/SHARED
THIS DOCUMENT IS THE PROPERTY OF LENOVO. IT IS TO BE USED ONLY FOR THE PURPOSES SPECIFIED IN THE TITLE. ANY REUSE OR REPRODUCTION OF THIS DOCUMENT WITHOUT THE WRITTEN PERMISSION OF LENOVO PURCHASING DEPARTMENT IS STRICTLY PROHIBITED. ALL QUESTIONS MUST BE REFERRED TO THE LENOVO PURCHASING DEPARTMENT.				

http://shop36609371.taobao.com 笔记本维修资料

42W9341





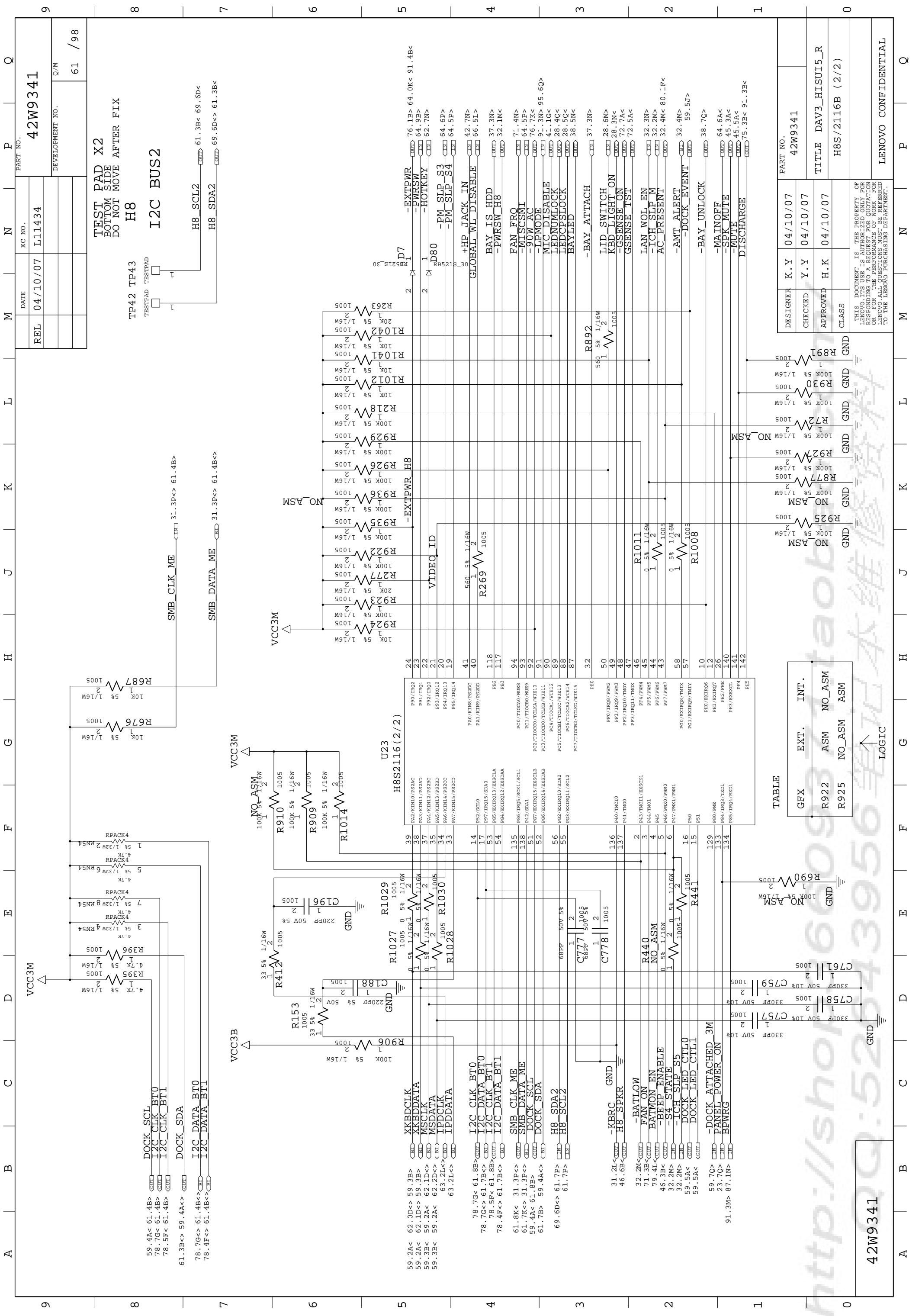

REL	04/10/07	L11434	PART NO.	42W9341
DATE	04/10/07	L11434	DEVELOPMENT NO.	Q/M
TEST PAD X2		DO NOT MOVE AFTER FIX		
H8				
I2C BUS2				
H8_SCL2		61.3B< 69.6D<		
H8_SDA2		69.6D< 61.3B<		

59.4A< 61.4B>	DOCK_SCL	61.3B< 59.4A<
78.7G< 61.4B>	I2C_CLK_BT0	I2C_DATA_BT0
78.5F< 61.4B>	I2C_CLK_BT1	I2C_DATA_BT1
61.3B< 59.4A<	DOCK_SDA	
78.7G< 61.4B>	I2C_DATA_BT0	
78.4F< 61.4B>	I2C_DATA_BT1	

TP42 TP43  
TESTPAD TESTPAD

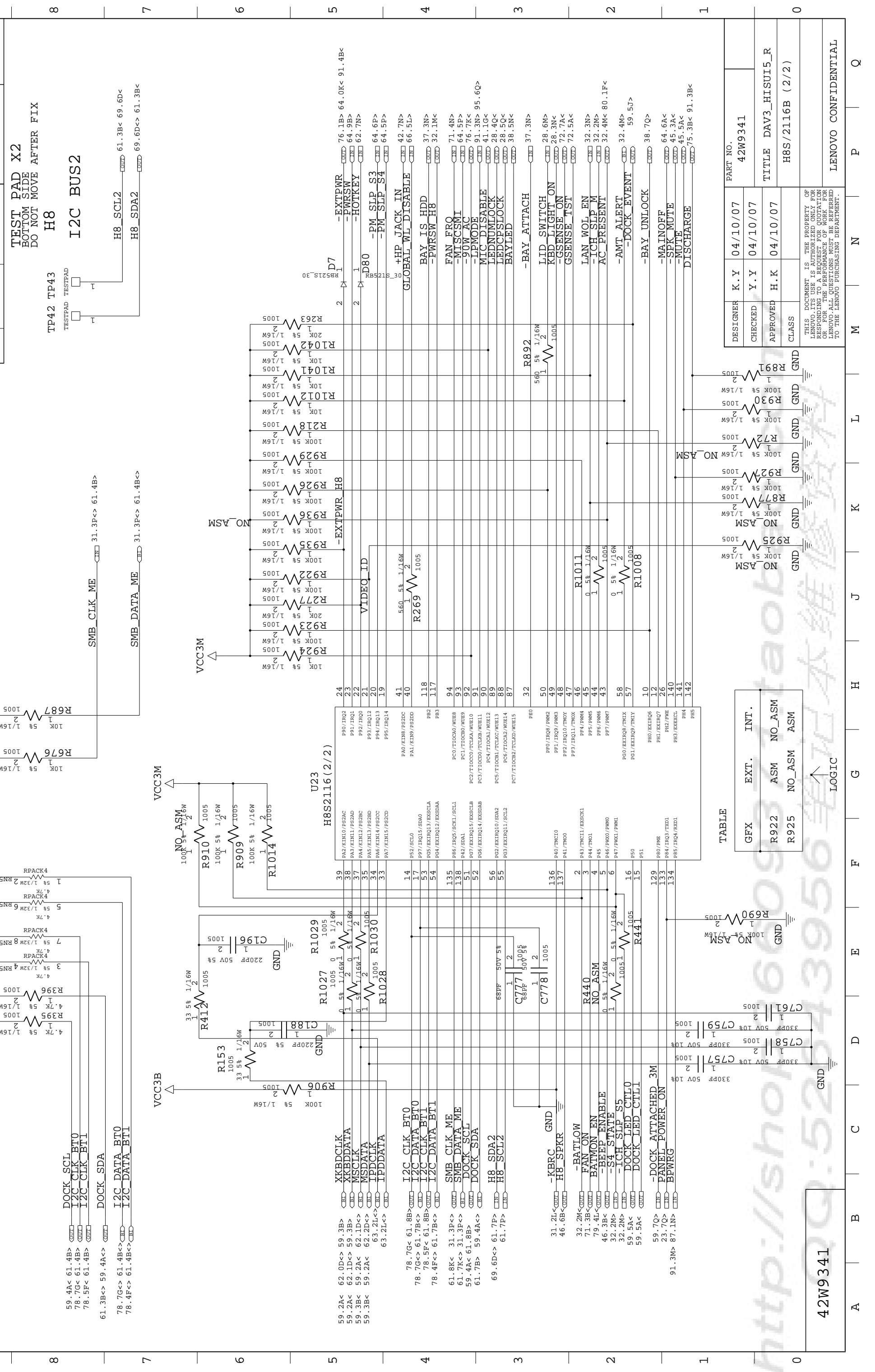

SMB\_CLK\_ME 31.3P< 61.4B>  
SMB\_DATA\_ME 31.3P< 61.4B>

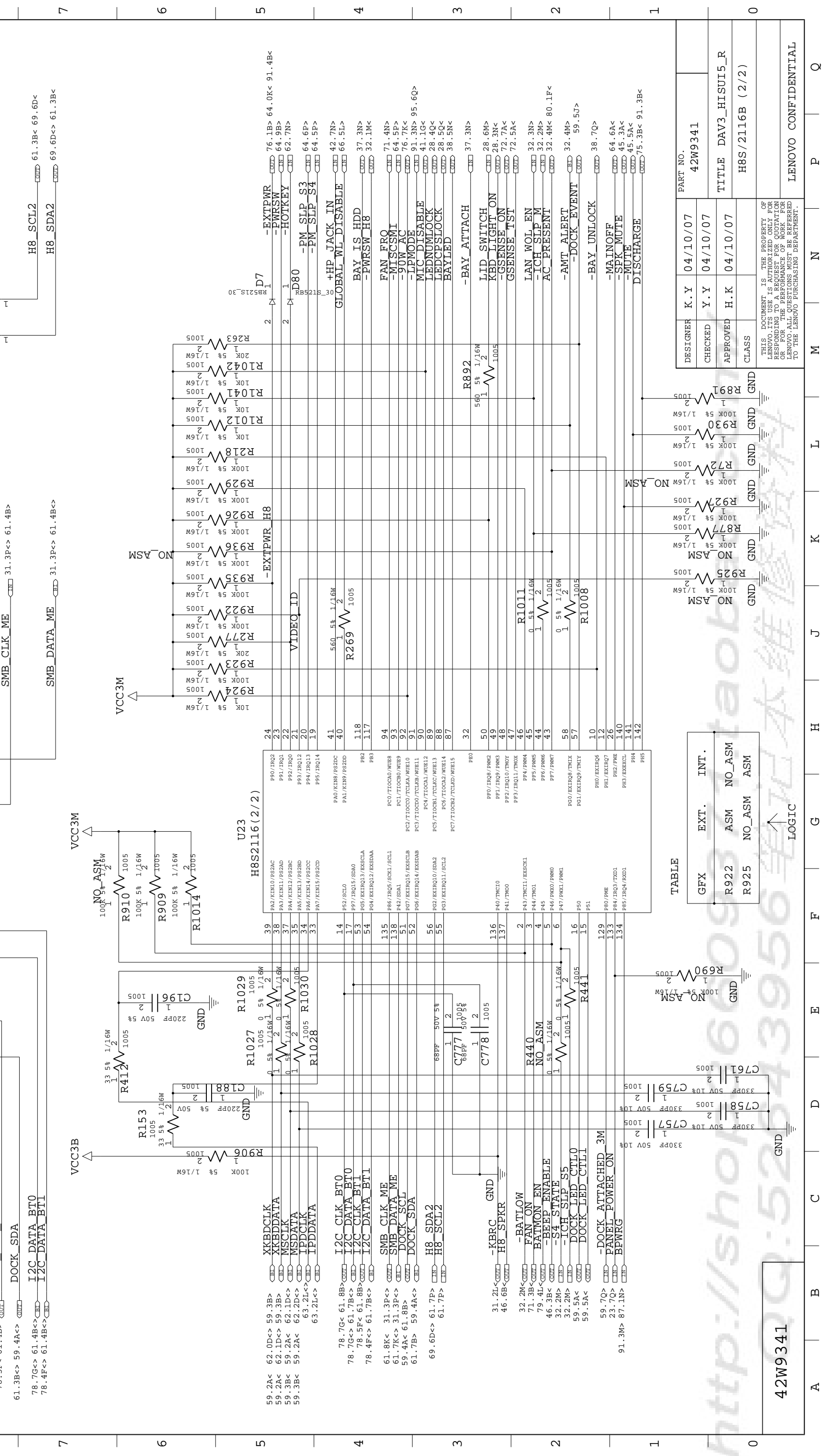

VIDEO\_ID  
EXT\_PWR\_H8  
GLOBAL\_WL\_DISABLE

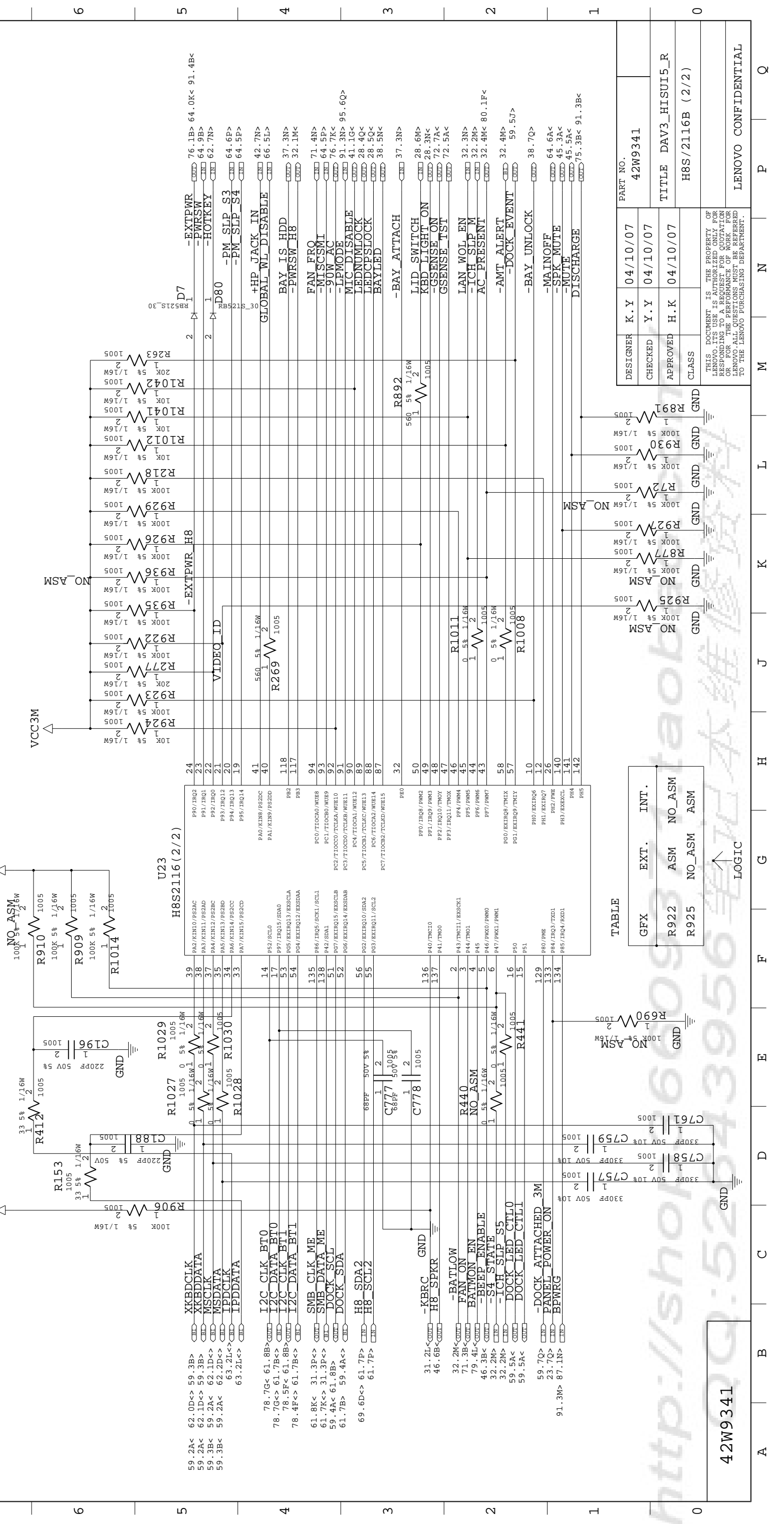

FAN FRO  
MISC\_SMI  
ICH\_SLP\_S5

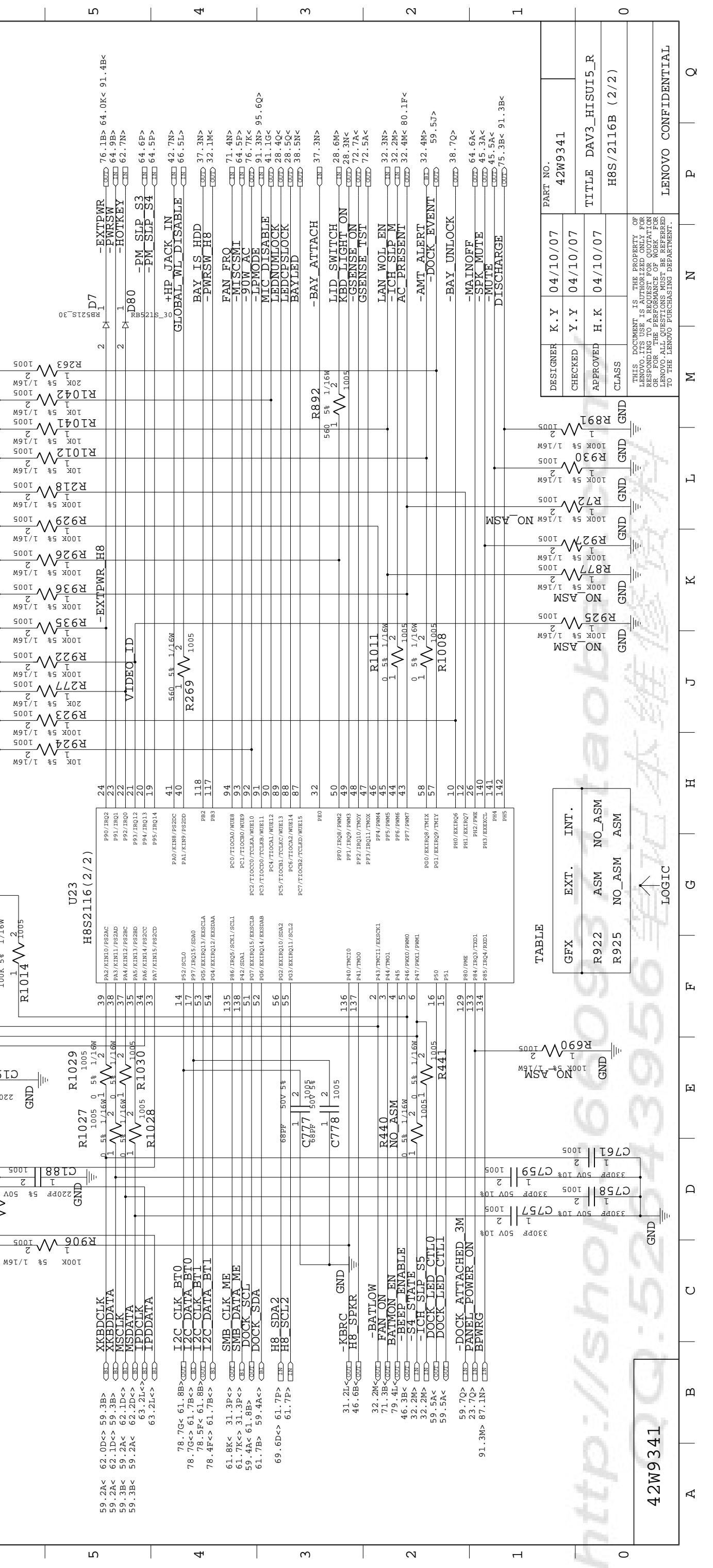

BAY\_ATTACH  
LID\_SWITCH  
-DOCK\_EVENT

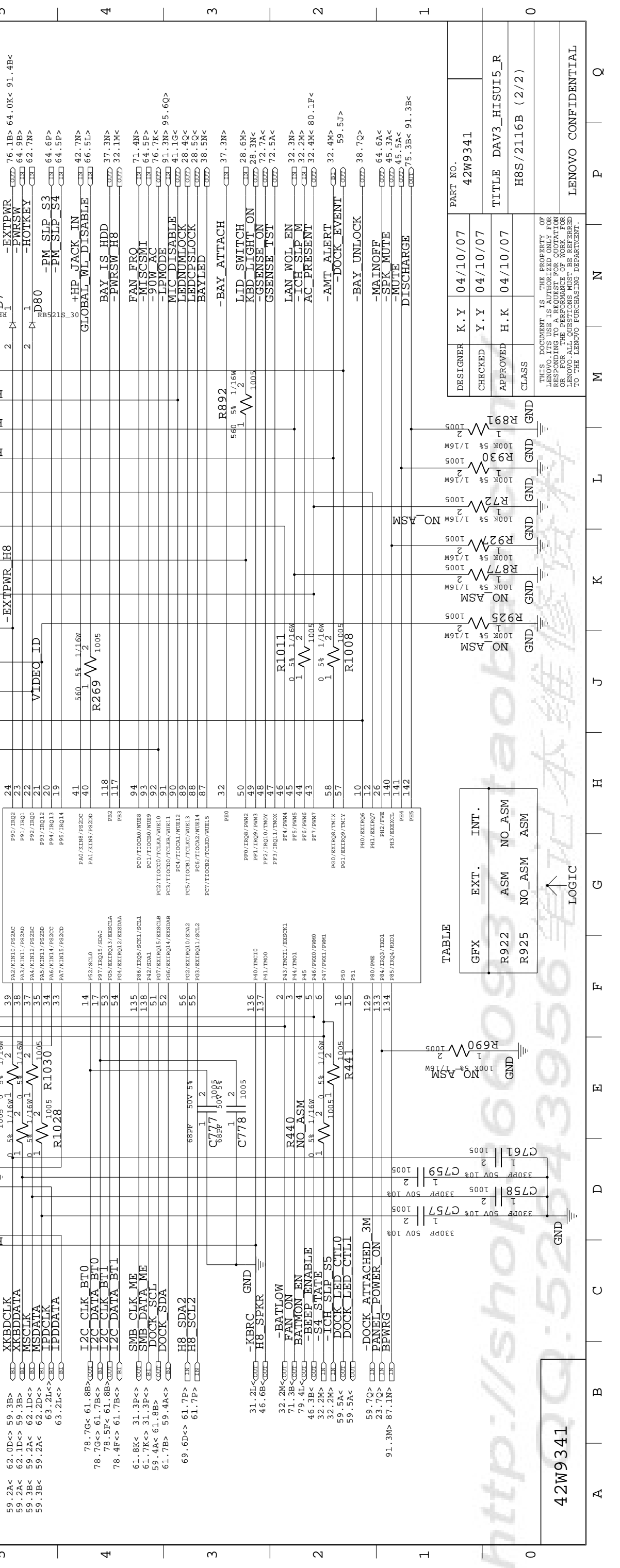

-BAY\_UNLOCK  
-MAINOFF  
-SPK\_MUTE

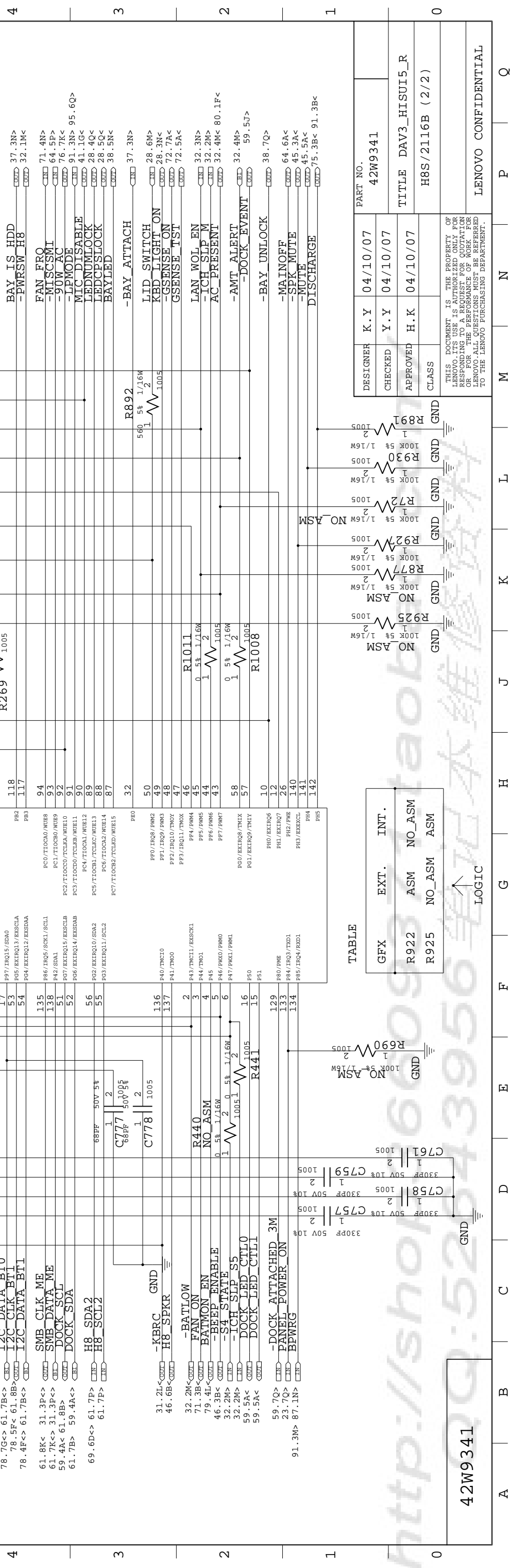

DISCHARGE

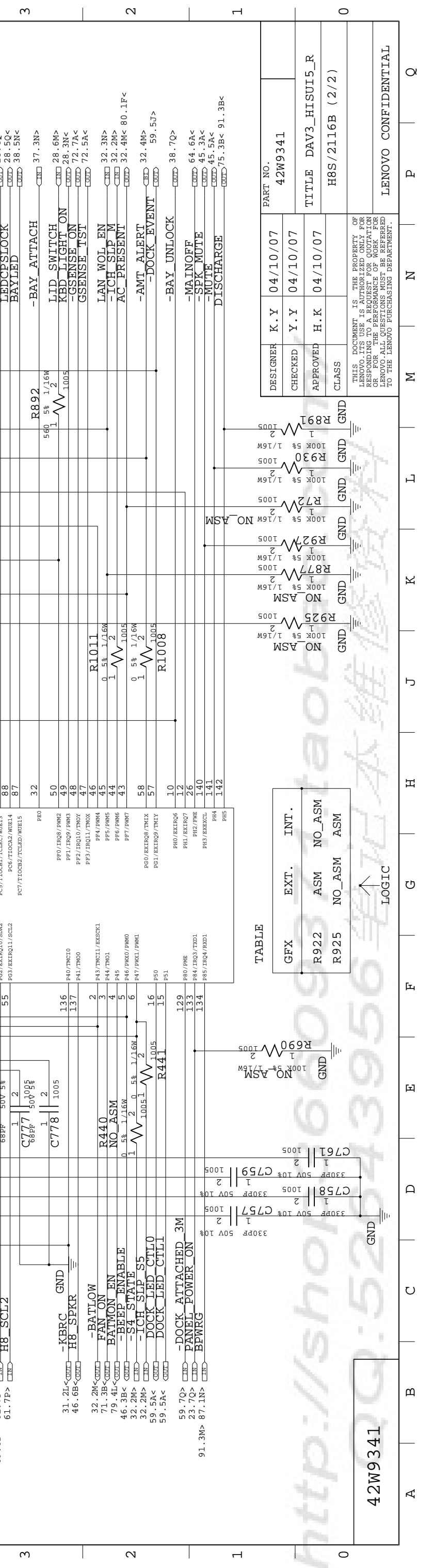

NO\_ASM

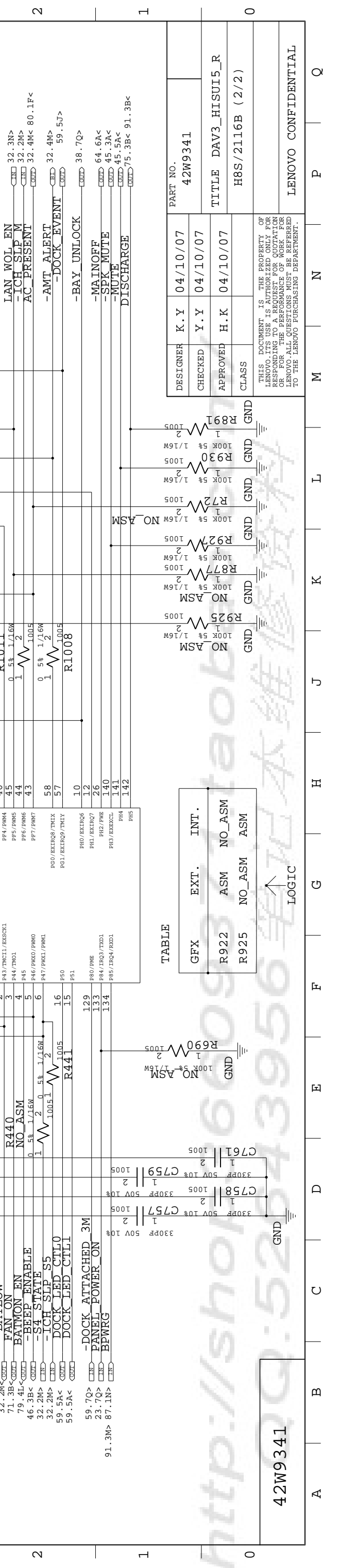

NO\_ASM

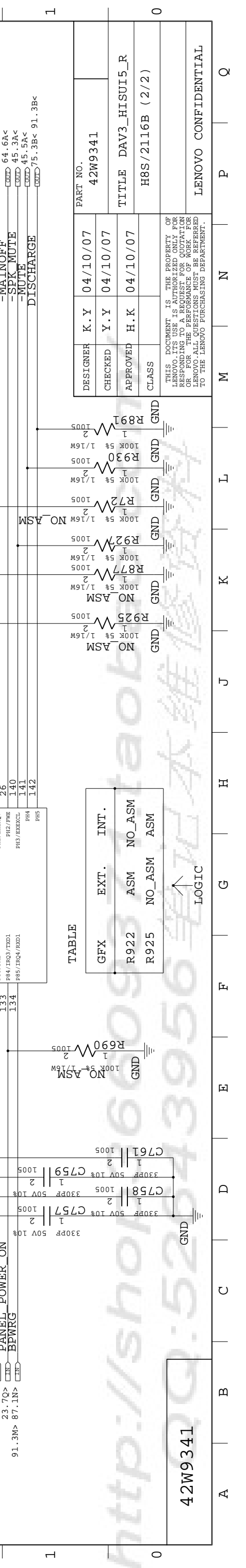

NO\_ASM

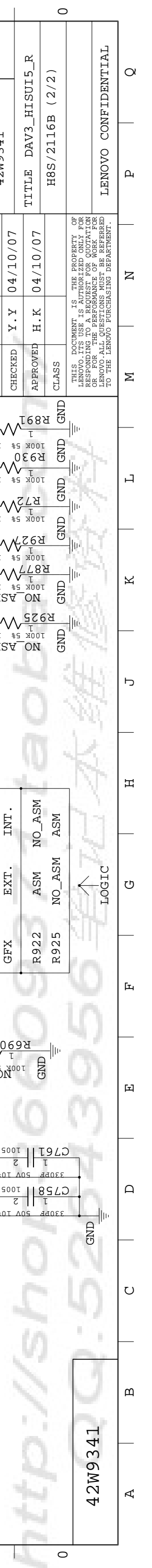

NO\_ASM



NO\_ASM

DESIGNER	K.Y	04/10/07	PART NO.	42W9341
CHECKED	Y.Y	04/10/07	TITLE	DAV3_HISUI5_R
APPROVED	H.K	04/10/07		H8S/2116B (2/2)
CLASS				

THIS DOCUMENT IS THE PROPERTY OF				
LENOVO. IT IS NOT TO BE REPRODUCED				
OR FOR THE PERFORMANCE OF WORK FOR				
LENOVO. ALL QUESTIONS MUST BE REFERRED				
TO THE LENOVO PURCHASING DEPARTMENT.				

42W9341

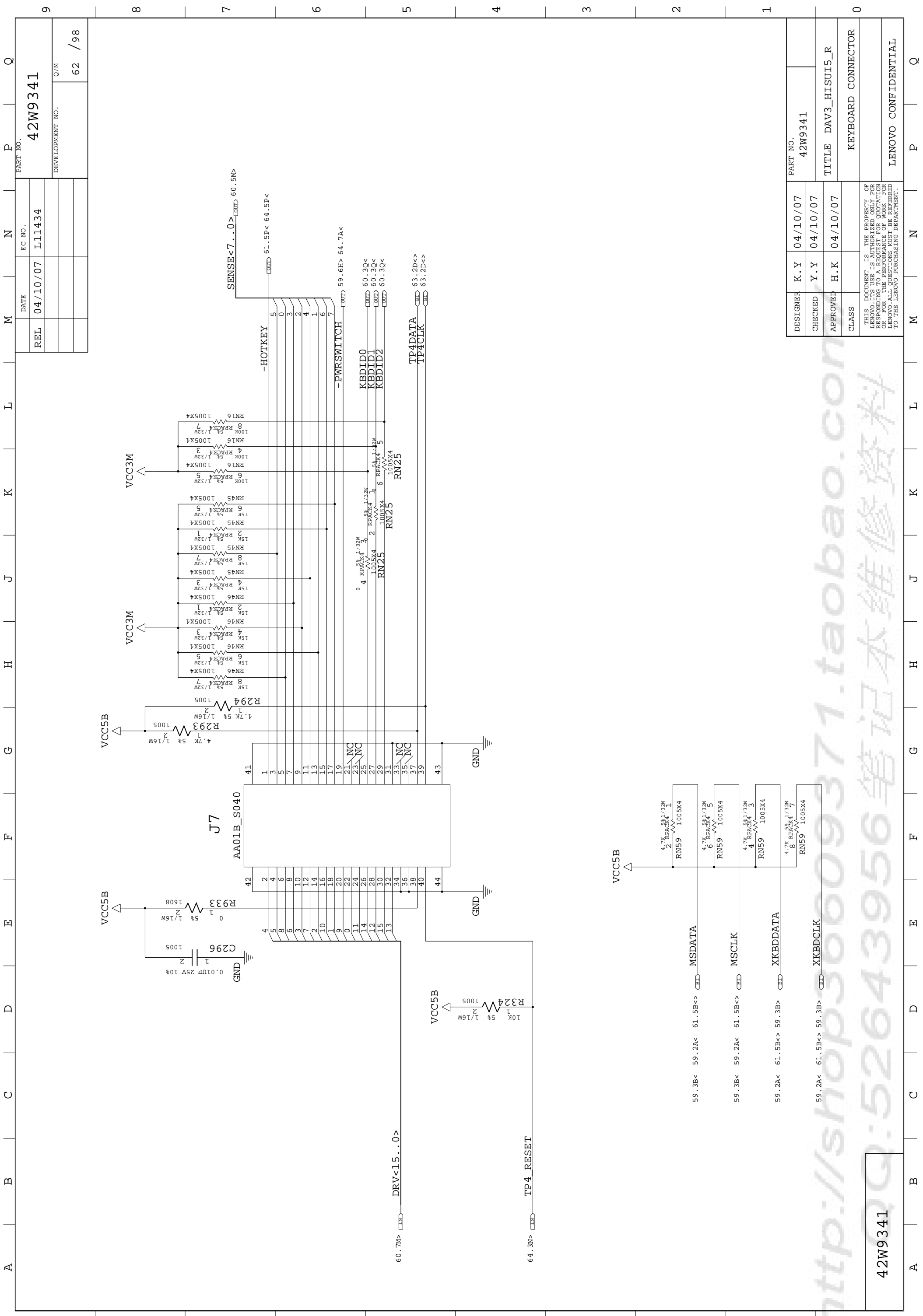

REL	DATE	EC NO.	PART NO.
	04/10/07	L11434	42W9341
			DEVELOPMENT NO.
			Q/M
			62 / 98

DESIGNER	K.Y	04/10/07	PART NO.	42W9341
CHECKED	Y.Y	04/10/07	TITLE	DAV3_HISUI5_R
APPROVED	H.K	04/10/07	CLASS	KEYBOARD CONNECTOR
THIS DOCUMENT IS THE PROPERTY OF LENOVO. IT IS LOANED TO YOU FOR USE ONLY. IT IS NOT TO BE REPRODUCED OR TRANSMITTED IN ANY FORM OR BY ANY MEANS, ELECTRONIC OR MECHANICAL, INCLUDING PHOTOCOPYING, RECORDING, OR BY ANY INFORMATION STORAGE AND RETRIEVAL SYSTEM. FOR MORE INFORMATION, CONTACT THE LENOVO PURCHASING DEPARTMENT.				

http://shop36609371.taobao.com 笔记本维修资料

42W9341

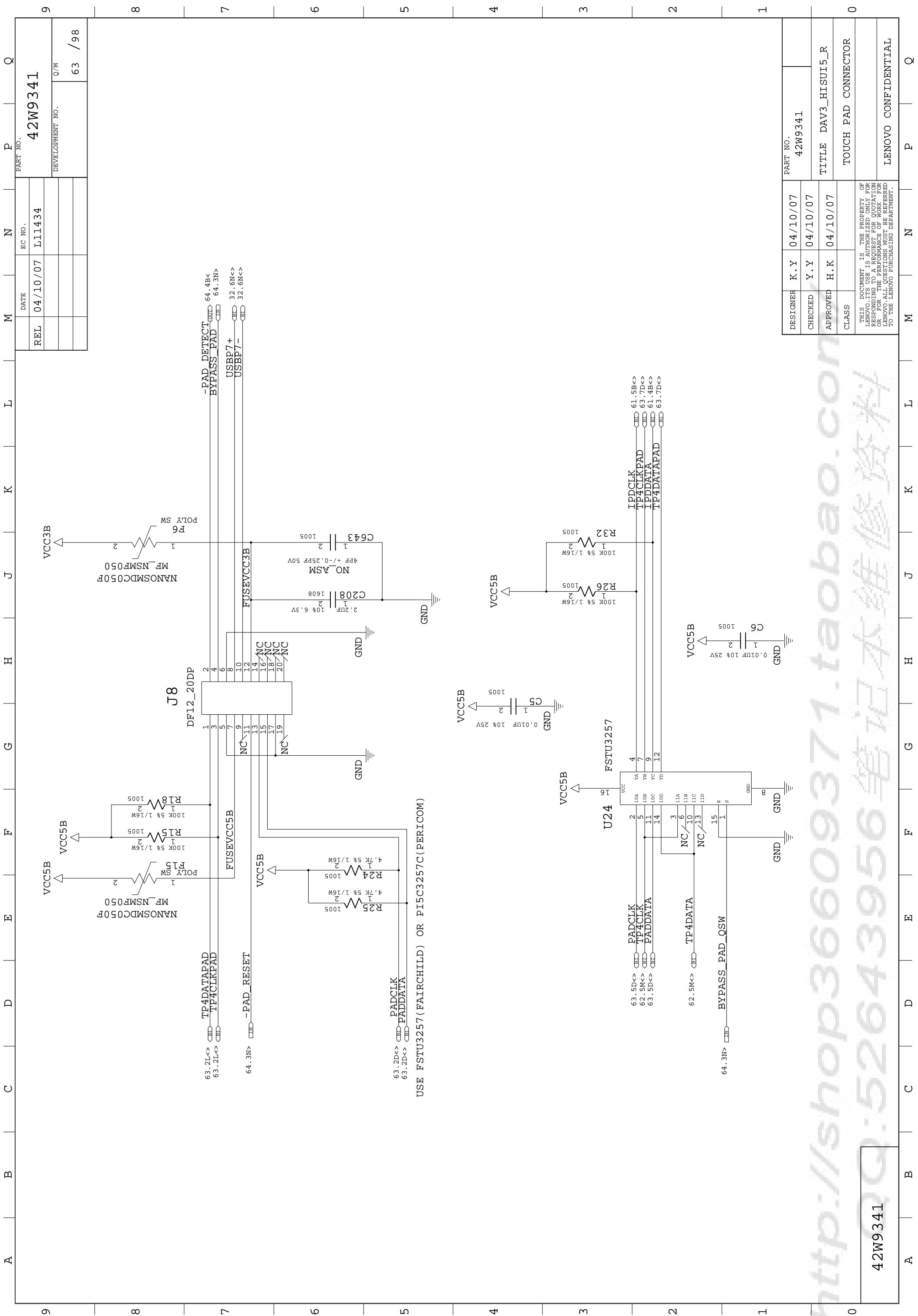

USE FSTU3257 (FAIRCHILD) OR PI5C3257C (PERICOM)

REL	DATE	EC NO.	PART NO.
	04/10/07	L11434	42W9341
			DEVELOPMENT NO.
			Q/M
			63 / 98

DESIGNER	K.Y	04/10/07	PART NO.	42W9341
CHECKED	Y.Y	04/10/07	TITLE	DAV3_HISUI5_R
APPROVED	H.K	04/10/07		TOUCH PAD CONNECTOR
CLASS				

THIS DOCUMENT IS THE PROPERTY OF LENOVO. IT IS LOANED TO YOU FOR USE ONLY. IT IS NOT TO BE REPRODUCED OR TRANSMITTED IN ANY FORM OR BY ANY MEANS, ELECTRONIC OR MECHANICAL, INCLUDING PHOTOCOPYING, RECORDING, OR BY ANY INFORMATION STORAGE AND RETRIEVAL SYSTEM. ALL RIGHTS RESERVED. FOR MORE INFORMATION, CONTACT THE LENOVO PURCHASING DEPARTMENT.

http://shop36609371.taobao.com 笔记本维修资料

42W9341





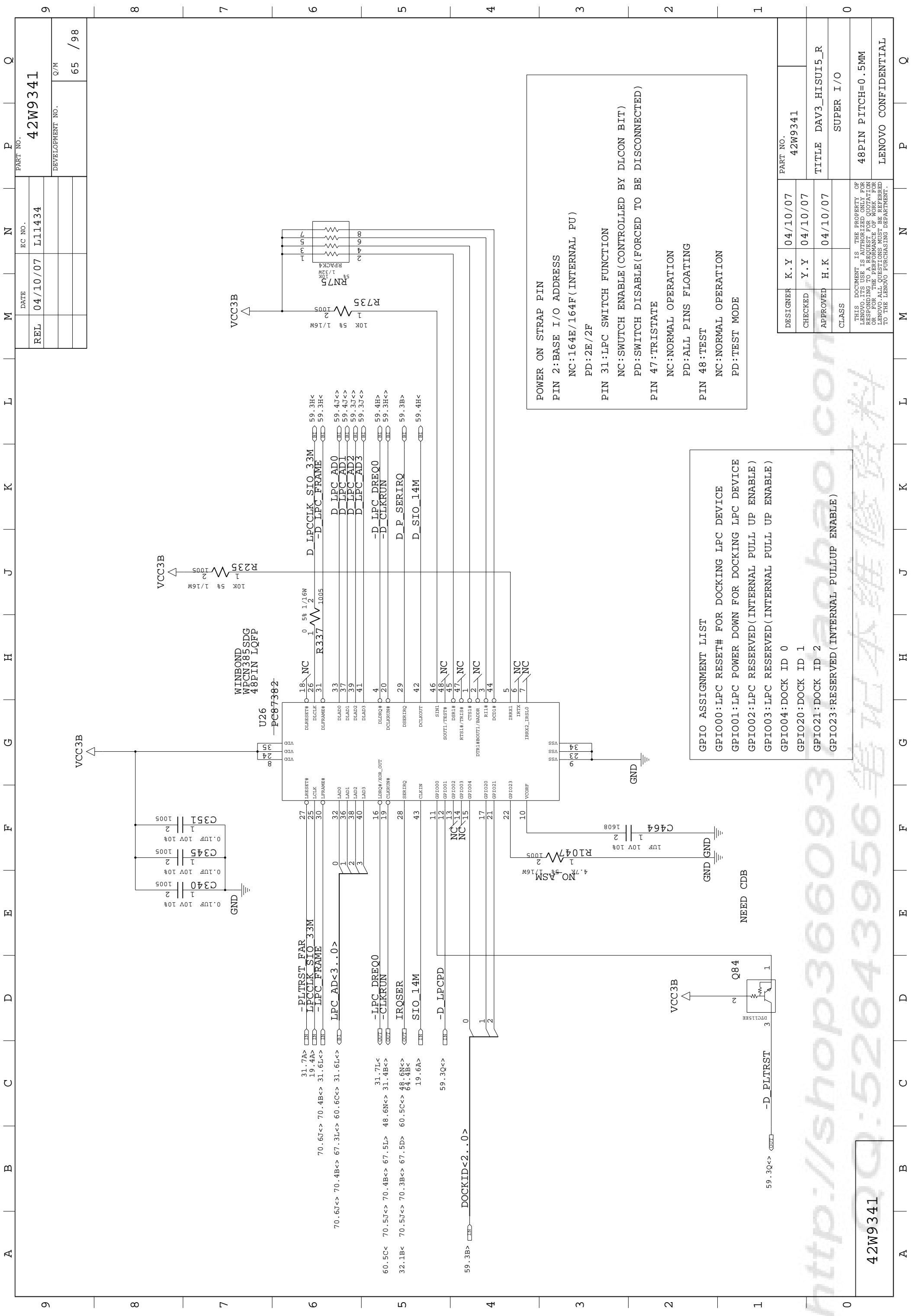

REL	04/10/07	L11434	42W9341
DATE	04/10/07	L11434	42W9341
EC NO.			
PART NO.			
DEVELOPMENT NO.			
Q/M			
			65 / 98

DESIGNER	K.Y	04/10/07	PART NO.	42W9341
CHECKED	Y.Y	04/10/07	TITLE	DAV3_HISUI5_R
APPROVED	H.K	04/10/07		SUPER I/O
CLASS				

THIS DOCUMENT IS THE PROPERTY OF LENOVO. IT IS TO BE USED ONLY FOR THE PURPOSES SPECIFIED HEREIN. ANY REPRODUCTION OR DISTRIBUTION OF THIS DOCUMENT WITHOUT THE WRITTEN PERMISSION OF LENOVO IS STRICTLY PROHIBITED. ALL RIGHTS RESERVED.

42W9341

M	N	P	Q
REL	DATE	EC NO.	PART NO.
	04/10/07	L11434	42W9341
			DEVELOPMENT NO.
			Q/M
			66 /98

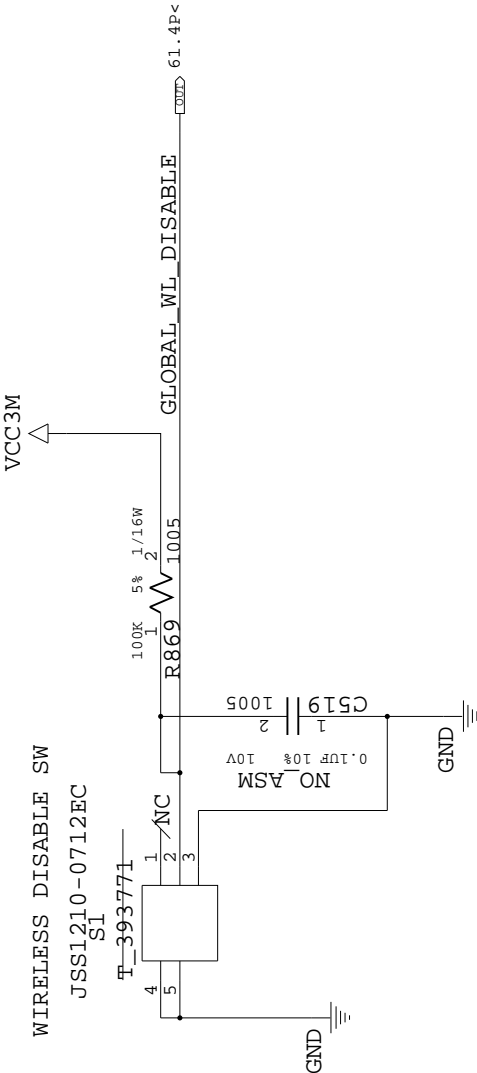

DESIGNER	K.Y	04/10/07	PART NO.	42W9341
CHECKED	Y.Y	04/10/07	TITLE	DAV3_HISUI5_R
APPROVED	H.K	04/10/07		WIRELESS DISABLE SW
CLASS				

THIS DOCUMENT IS THE PROPERTY OF LENOVO. IT IS LOANED TO YOU FOR USE ONLY. IT IS NOT TO BE REPRODUCED OR TRANSMITTED IN ANY FORM OR BY ANY MEANS, ELECTRONIC OR MECHANICAL, INCLUDING PHOTOCOPYING, RECORDING, OR BY ANY INFORMATION STORAGE AND RETRIEVAL SYSTEM. FOR MORE INFORMATION, CONTACT THE LENOVO PURCHASING DEPARTMENT. ALL RIGHTS RESERVED. © 2007 LENOVO CORPORATION. ALL RIGHTS RESERVED. FOR MORE INFORMATION, CONTACT THE LENOVO PURCHASING DEPARTMENT.

42W9341

http://shop36609371.taobao.com 笔记本维修资料

REL	04/10/07	L11434	42W9341
DATE	04/10/07	L11434	42W9341
EC NO.			
PART NO.			
DEVELOPMENT NO.			
Q/M			
			67 / 98

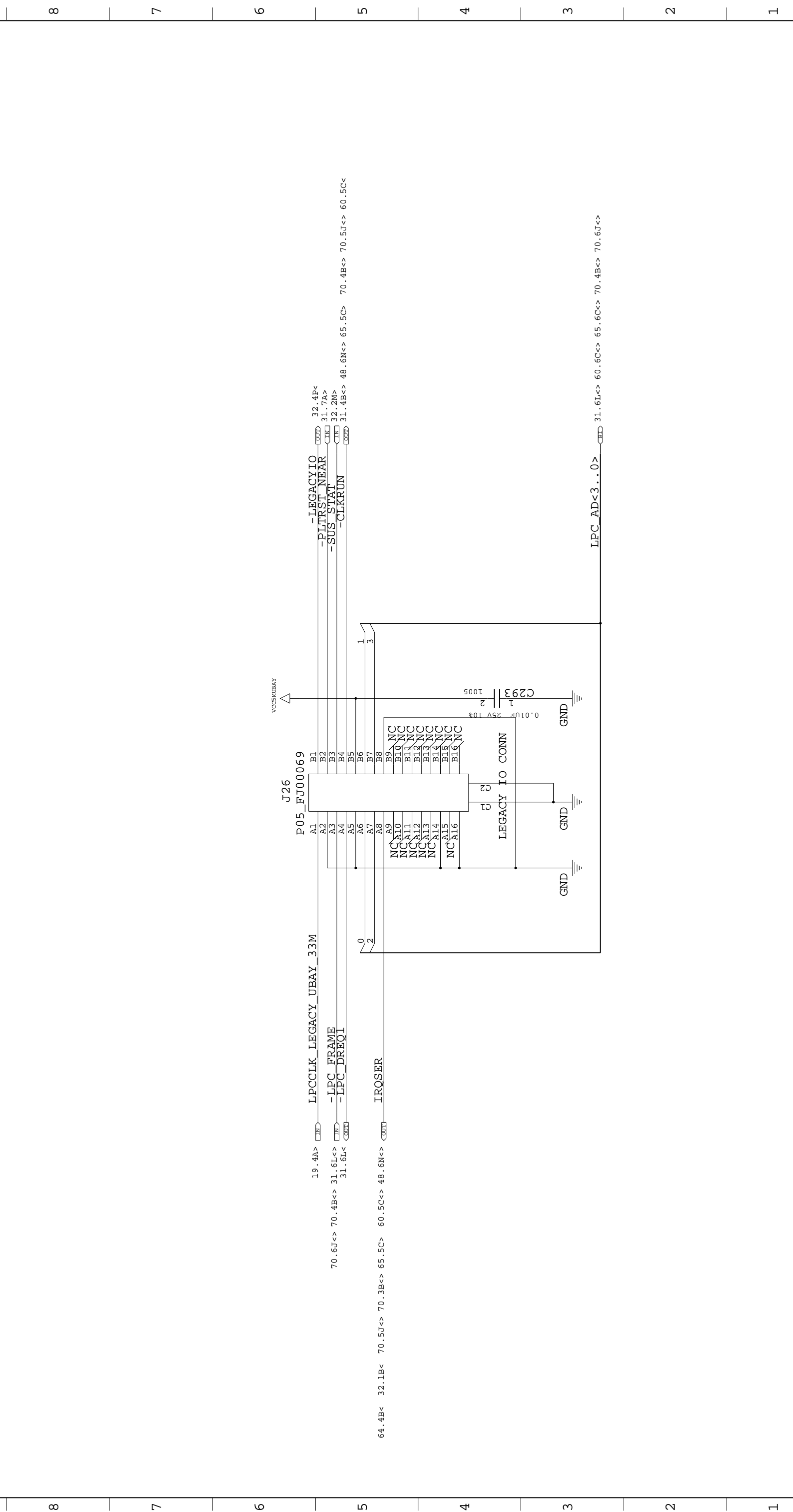

DESIGNER	K.Y	04/10/07	PART NO.	42W9341
CHECKED	Y.Y	04/10/07	TITLE	DAV3_HISUI5_R
APPROVED	H.K	04/10/07	CLASS	SERIAL INTERFACE
THIS DOCUMENT IS THE PROPERTY OF LENOVO. IT IS LOANED TO YOU FOR YOUR USE ONLY. IT IS NOT TO BE REPRODUCED OR TRANSMITTED IN ANY FORM OR BY ANY MEANS, ELECTRONIC OR MECHANICAL, INCLUDING PHOTOCOPYING, RECORDING, OR BY ANY INFORMATION STORAGE AND RETRIEVAL SYSTEM. FOR MORE INFORMATION, CONTACT YOUR LENOVO PURCHASING DEPARTMENT.				
42W9341				

http://shop36609371.taobao.com 笔记本维修资料

REL		DATE	EC NO.	PART NO.
		04/10/07	L11434	42W9341
				DEVELOPMENT NO.
				68 / 98
				Q/M

# BLANK PAGE

DESIGNER	K.Y	04/10/07	PART NO.
CHECKED	Y.Y	04/10/07	42W9341
APPROVED	H.K	04/10/07	TITLE DAV3_HISUI5_R
CLASS			BLANK PAGE
<small>THIS DOCUMENT IS THE PROPERTY OF LENOVO. IT IS LOANED TO YOU BY THE PURCHASER. IT IS TO BE USED ONLY FOR THE PURPOSES SPECIFIED IN THE ORDER. IT IS NOT TO BE REPRODUCED OR TRANSMITTED IN ANY FORM OR BY ANY MEANS, ELECTRONIC OR MECHANICAL, INCLUDING PHOTOCOPYING, RECORDING, OR BY ANY INFORMATION STORAGE AND RETRIEVAL SYSTEM, WITHOUT PERMISSION IN WRITING FROM LENOVO. ALL QUESTIONS MUST BE REFERRED TO THE LENOVO PURCHASING DEPARTMENT.</small>			

http://shop36609371.taobao.com

52643956 笔记本维修资料

42W9341

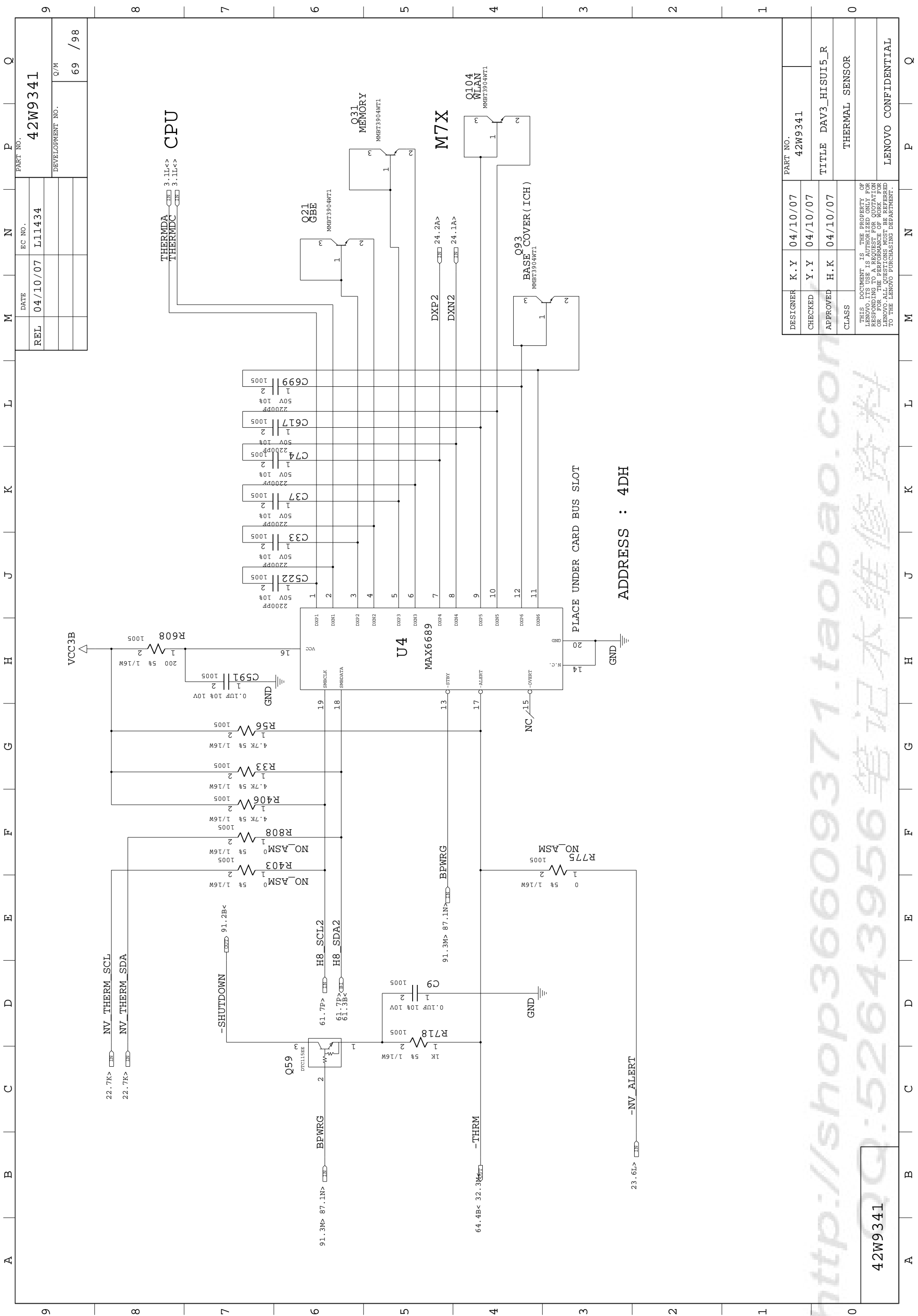

REL	04/10/07	L11434	42W9341
DATE	04/10/07	L11434	42W9341
EC NO.			
PART NO.			
DEVELOPMENT NO.			
Q/M			
			69 / 98

DESIGNER	K.Y	04/10/07	PART NO.	42W9341
CHECKED	Y.Y	04/10/07	TITLE	DAV3_HISUI5_R
APPROVED	H.K	04/10/07	CLASS	THERMAL SENSOR
THIS DOCUMENT IS THE PROPERTY OF LENOVO. IT IS LOANED TO YOU FOR USE ONLY. IT IS NOT TO BE REPRODUCED OR TRANSMITTED IN ANY FORM OR BY ANY MEANS, ELECTRONIC OR MECHANICAL, INCLUDING PHOTOCOPYING, RECORDING, OR BY ANY INFORMATION STORAGE AND RETRIEVAL SYSTEM. ALL RIGHTS ARE RESERVED. FOR MORE INFORMATION, CONTACT YOUR LENOVO ACCOUNT MANAGER OR THE LENOVO PURCHASING DEPARTMENT.				
LENOVO CONFIDENTIAL				

http://shop36609371.taobao.com 笔记本维修资料

42W9341

PLACE UNDER CARD BUS SLOT  
ADDRESS : 4DH

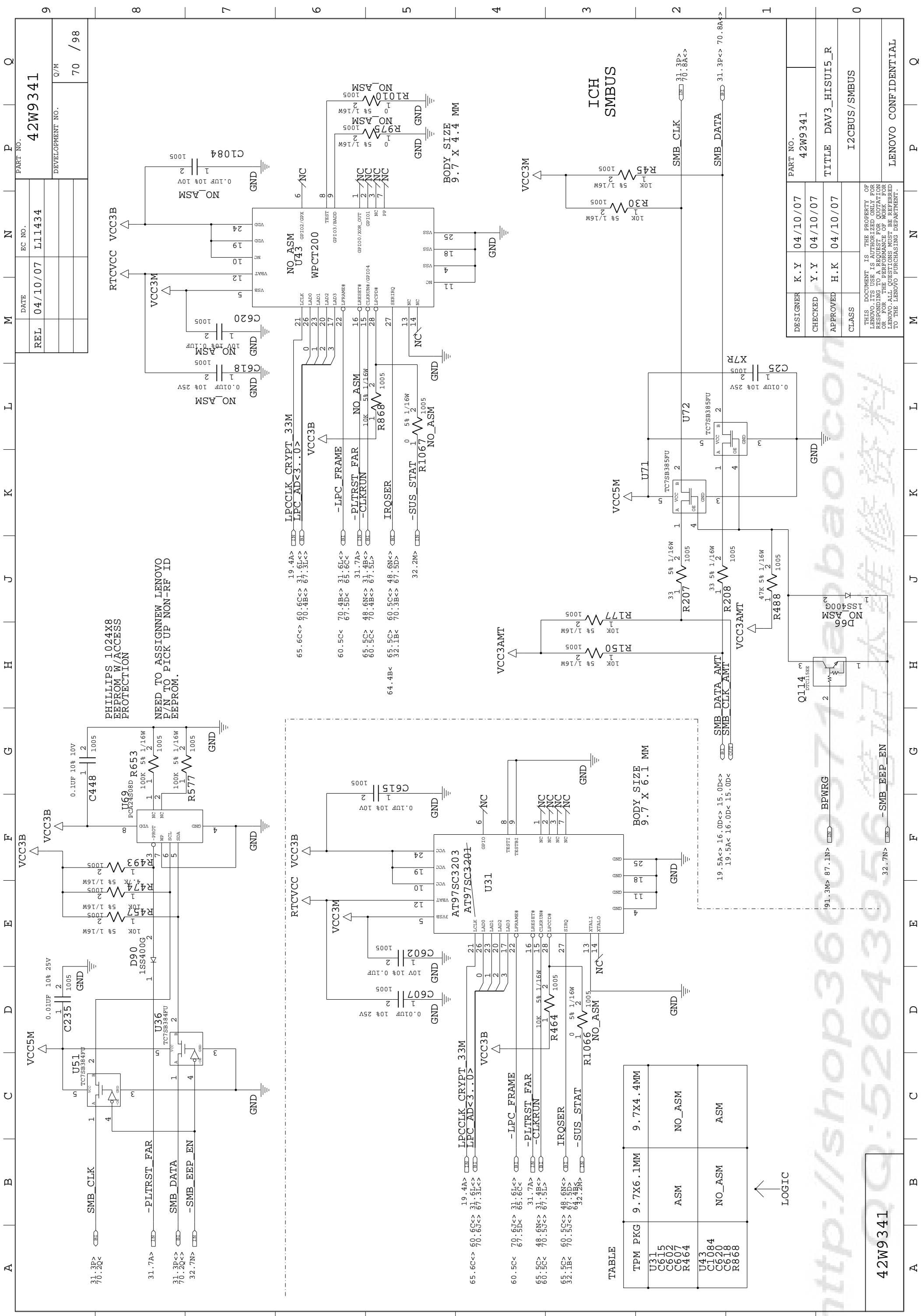

REL	04/10/07	L11434	42W9341
DATE	04/10/07	L11434	42W9341
EC NO.			
PART NO.			
DEVELOPMENT NO.			
Q/M			
			70 / 98

DESIGNER	K.Y	04/10/07	42W9341
CHECKED	Y.Y	04/10/07	
APPROVED	H.K	04/10/07	
CLASS			

PHILIPS 1024X8 EEPROM W/ACCESS PROTECTION

NEED TO ASSIGN NEW LENOVO P/N TO PICK UP NON-RF ID EEPROM.

TPM PKG	9.7X6.1MM	9.7X4.4MM
U31	ASM	NO_ASM
C615		
C602		
C607		
R464		
U43	NO_ASM	ASM
C1084		
C620		
C618		
R868		

LOGIC

DESIGNER	K.Y	04/10/07	42W9341
CHECKED	Y.Y	04/10/07	
APPROVED	H.K	04/10/07	
CLASS			

42W9341

TABLE

TPM PKG	9.7X6.1MM	9.7X4.4MM
U31	ASM	NO_ASM
C615		
C602		
C607		
R464		
U43	NO_ASM	ASM
C1084		
C620		
C618		
R868		

LOGIC

DESIGNER	K.Y	04/10/07	42W9341
CHECKED	Y.Y	04/10/07	
APPROVED	H.K	04/10/07	
CLASS			

42W9341

DESIGNER	K.Y	04/10/07	42W9341
CHECKED	Y.Y	04/10/07	
APPROVED	H.K	04/10/07	
CLASS			

42W9341

DESIGNER	K.Y	04/10/07	42W9341
CHECKED	Y.Y	04/10/07	
APPROVED	H.K	04/10/07	
CLASS			

42W9341

DESIGNER	K.Y	04/10/07	42W9341
CHECKED	Y.Y	04/10/07	
APPROVED	H.K	04/10/07	
CLASS			

42W9341

DESIGNER	K.Y	04/10/07	42W9341
CHECKED	Y.Y	04/10/07	
APPROVED	H.K	04/10/07	
CLASS			

42W9341

http://shop36609371.taobao.com 维修资料

THIS DOCUMENT IS THE PROPERTY OF LENOVO. IT IS LOANED TO YOU FOR USE ONLY. IT IS NOT TO BE REPRODUCED OR TRANSMITTED IN ANY FORM OR BY ANY MEANS, ELECTRONIC OR MECHANICAL, INCLUDING PHOTOCOPYING, RECORDING, OR BY ANY INFORMATION STORAGE AND RETRIEVAL SYSTEM. ALL RIGHTS RESERVED. FOR MORE INFORMATION, CONTACT YOUR LENOVO ACCOUNT MANAGER OR THE LENOVO PURCHASING DEPARTMENT.

LENOVO CONFIDENTIAL

REL	04/10/07	L11434	42W9341
DATE	04/10/07	L11434	42W9341
EC NO.			
PART NO.			
DEVELOPMENT NO.		71 / 98	

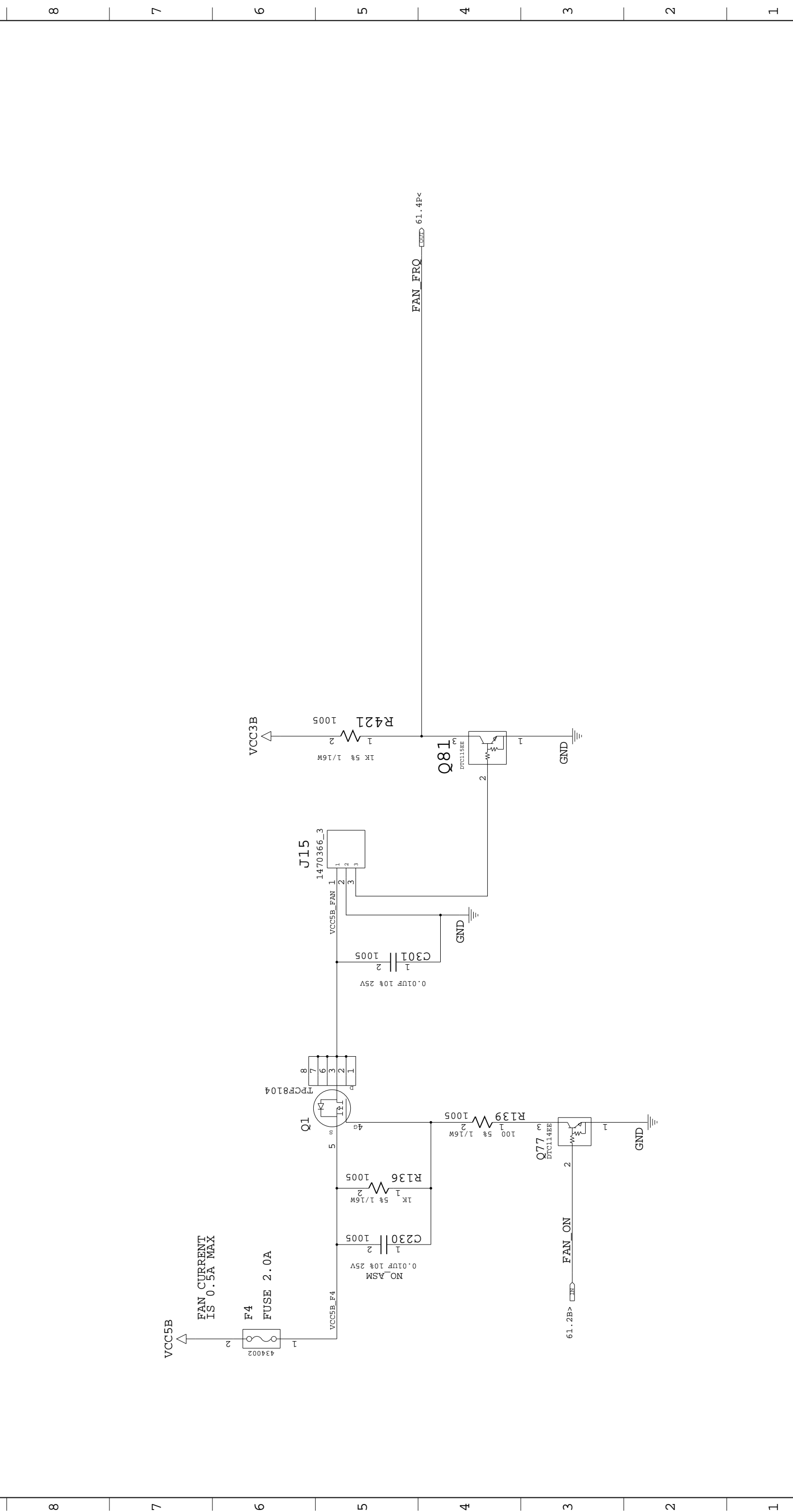

DESIGNER	K.Y	04/10/07	PART NO.	42W9341
CHECKED	Y.Y	04/10/07	TITLE	DAV3_HISUI5_R
APPROVED	H.K	04/10/07	CLASS	FAN CONNECTOR
THIS DOCUMENT IS THE PROPERTY OF LENOVO. IT IS LOANED TO YOU FOR USE ONLY IN CONNECTION WITH THE WORK PERFORMED FOR LENOVO. ALL QUESTIONS MUST BE REFERRED TO THE LENOVO PURCHASING DEPARTMENT.				

http://shop36609371.taobao.com 笔记本维修资料

42W9341

REL	DATE	EC NO.	PART NO.
	04/10/07	L11434	42W9341
			DEVELOPMENT NO.
			72 / 98

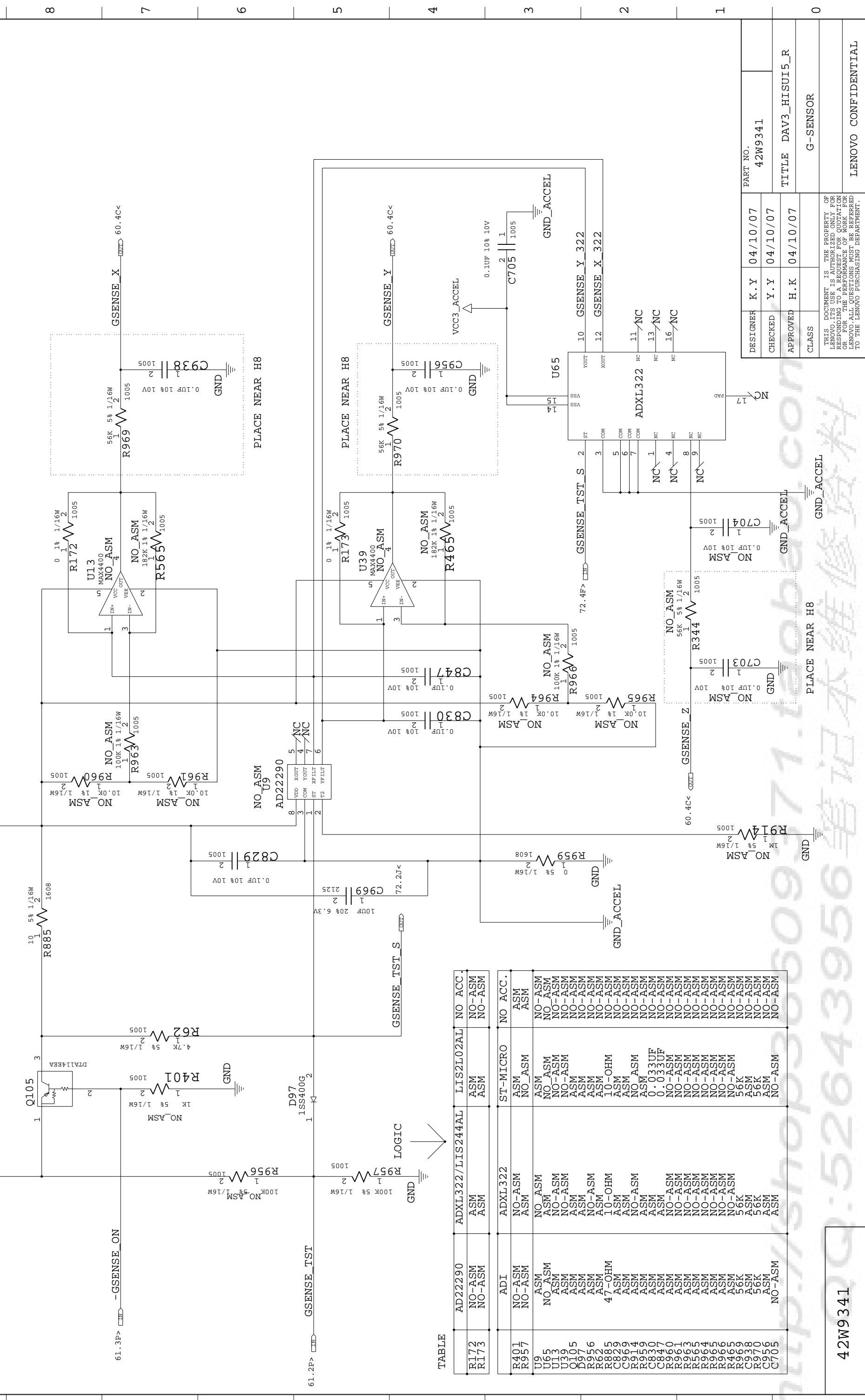

TABLE

R172	AD22290	NO-ASM	NO-ASM	LIS2L02AL	NO ACC.
R173	AD22290	NO-ASM	NO-ASM	LIS2L02AL	NO-ASM
R401	AD22290	NO-ASM	NO-ASM	LIS2L02AL	NO-ASM
R401	AD22290	NO-ASM	NO-ASM	LIS2L02AL	NO-ASM
U9	AD22290	NO-ASM	NO-ASM	LIS2L02AL	NO-ASM
U65	AD22290	NO-ASM	NO-ASM	LIS2L02AL	NO-ASM
U13	AD22290	NO-ASM	NO-ASM	LIS2L02AL	NO-ASM
U39	AD22290	NO-ASM	NO-ASM	LIS2L02AL	NO-ASM
Q105	AD22290	NO-ASM	NO-ASM	LIS2L02AL	NO-ASM
D97	AD22290	NO-ASM	NO-ASM	LIS2L02AL	NO-ASM
R956	AD22290	NO-ASM	NO-ASM	LIS2L02AL	NO-ASM
R957	AD22290	NO-ASM	NO-ASM	LIS2L02AL	NO-ASM
R959	AD22290	NO-ASM	NO-ASM	LIS2L02AL	NO-ASM
R966	AD22290	NO-ASM	NO-ASM	LIS2L02AL	NO-ASM
R967	AD22290	NO-ASM	NO-ASM	LIS2L02AL	NO-ASM
R968	AD22290	NO-ASM	NO-ASM	LIS2L02AL	NO-ASM
R969	AD22290	NO-ASM	NO-ASM	LIS2L02AL	NO-ASM
R970	AD22290	NO-ASM	NO-ASM	LIS2L02AL	NO-ASM
R971	AD22290	NO-ASM	NO-ASM	LIS2L02AL	NO-ASM
R972	AD22290	NO-ASM	NO-ASM	LIS2L02AL	NO-ASM
R973	AD22290	NO-ASM	NO-ASM	LIS2L02AL	NO-ASM
R974	AD22290	NO-ASM	NO-ASM	LIS2L02AL	NO-ASM
R975	AD22290	NO-ASM	NO-ASM	LIS2L02AL	NO-ASM
R976	AD22290	NO-ASM	NO-ASM	LIS2L02AL	NO-ASM
R977	AD22290	NO-ASM	NO-ASM	LIS2L02AL	NO-ASM
R978	AD22290	NO-ASM	NO-ASM	LIS2L02AL	NO-ASM
R979	AD22290	NO-ASM	NO-ASM	LIS2L02AL	NO-ASM
R980	AD22290	NO-ASM	NO-ASM	LIS2L02AL	NO-ASM
R981	AD22290	NO-ASM	NO-ASM	LIS2L02AL	NO-ASM
R982	AD22290	NO-ASM	NO-ASM	LIS2L02AL	NO-ASM
R983	AD22290	NO-ASM	NO-ASM	LIS2L02AL	NO-ASM
R984	AD22290	NO-ASM	NO-ASM	LIS2L02AL	NO-ASM
R985	AD22290	NO-ASM	NO-ASM	LIS2L02AL	NO-ASM
R986	AD22290	NO-ASM	NO-ASM	LIS2L02AL	NO-ASM
R987	AD22290	NO-ASM	NO-ASM	LIS2L02AL	NO-ASM
R988	AD22290	NO-ASM	NO-ASM	LIS2L02AL	NO-ASM
R989	AD22290	NO-ASM	NO-ASM	LIS2L02AL	NO-ASM
R990	AD22290	NO-ASM	NO-ASM	LIS2L02AL	NO-ASM
R991	AD22290	NO-ASM	NO-ASM	LIS2L02AL	NO-ASM
R992	AD22290	NO-ASM	NO-ASM	LIS2L02AL	NO-ASM
R993	AD22290	NO-ASM	NO-ASM	LIS2L02AL	NO-ASM
R994	AD22290	NO-ASM	NO-ASM	LIS2L02AL	NO-ASM
R995	AD22290	NO-ASM	NO-ASM	LIS2L02AL	NO-ASM
R996	AD22290	NO-ASM	NO-ASM	LIS2L02AL	NO-ASM
R997	AD22290	NO-ASM	NO-ASM	LIS2L02AL	NO-ASM
R998	AD22290	NO-ASM	NO-ASM	LIS2L02AL	NO-ASM
R999	AD22290	NO-ASM	NO-ASM	LIS2L02AL	NO-ASM
R1000	AD22290	NO-ASM	NO-ASM	LIS2L02AL	NO-ASM

DESIGNER	K.Y	04/10/07	PART NO.	42W9341
CHECKED	Y.Y	04/10/07	TITLE	DAV3_HISUI5_R
APPROVED	H.K	04/10/07	CLASS	G-SENSOR
THIS DOCUMENT IS THE PROPERTY OF LENOVO. IT IS LOANED TO YOU FOR USE ONLY. IT IS NOT TO BE REPRODUCED OR TRANSMITTED IN ANY FORM OR BY ANY MEANS, ELECTRONIC OR MECHANICAL, INCLUDING PHOTOCOPYING, RECORDING, OR BY ANY INFORMATION STORAGE AND RETRIEVAL SYSTEM. FOR MORE INFORMATION, CONTACT YOUR LOCAL LENOVO OFFICE. ALL QUESTIONS MUST BE REFERRED TO THE LENOVO PURCHASING DEPARTMENT.				
LENOVO CONFIDENTIAL				



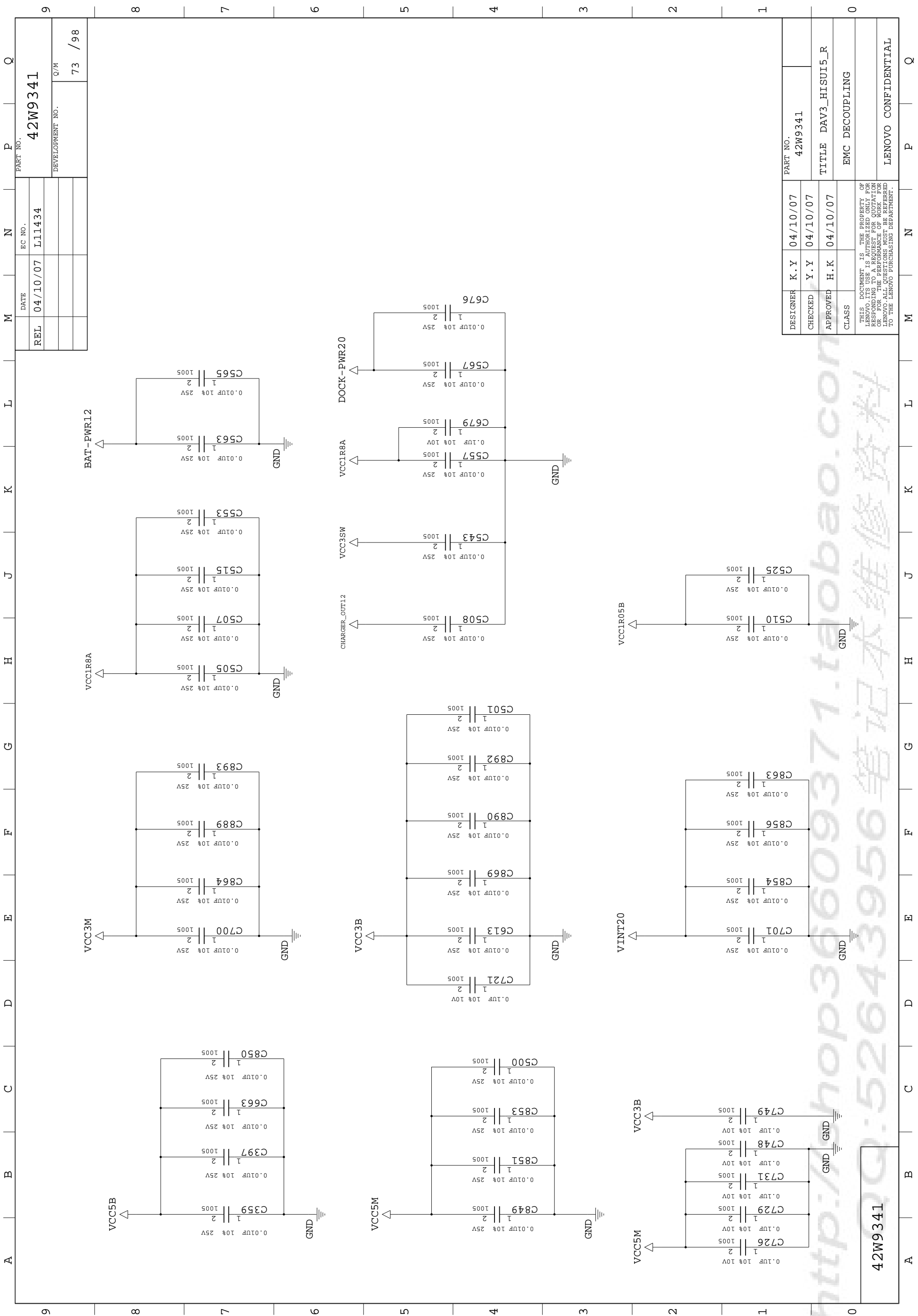

DESIGNER	K.Y	04/10/07	PART NO.	42W9341
CHECKED	Y.Y	04/10/07	TITLE	DAV3_HISUI5_R
APPROVED	H.K	04/10/07	CLASS	EMC DECOUPLING
<small>THIS DOCUMENT IS THE PROPERTY OF LENOVO. IT IS LOANED TO YOU FOR YOUR USE ONLY. IT IS NOT TO BE REPRODUCED OR TRANSMITTED IN ANY FORM OR BY ANY MEANS, ELECTRONIC OR MECHANICAL, INCLUDING PHOTOCOPYING, RECORDING, OR BY ANY INFORMATION STORAGE AND RETRIEVAL SYSTEM. ALL RIGHTS RESERVED. FOR MORE INFORMATION, CONTACT YOUR LENOVO ACCOUNT MANAGER OR THE LENOVO PURCHASING DEPARTMENT.</small>				

42W9341

http://shop36609371.taobao.com 笔记本维修资料

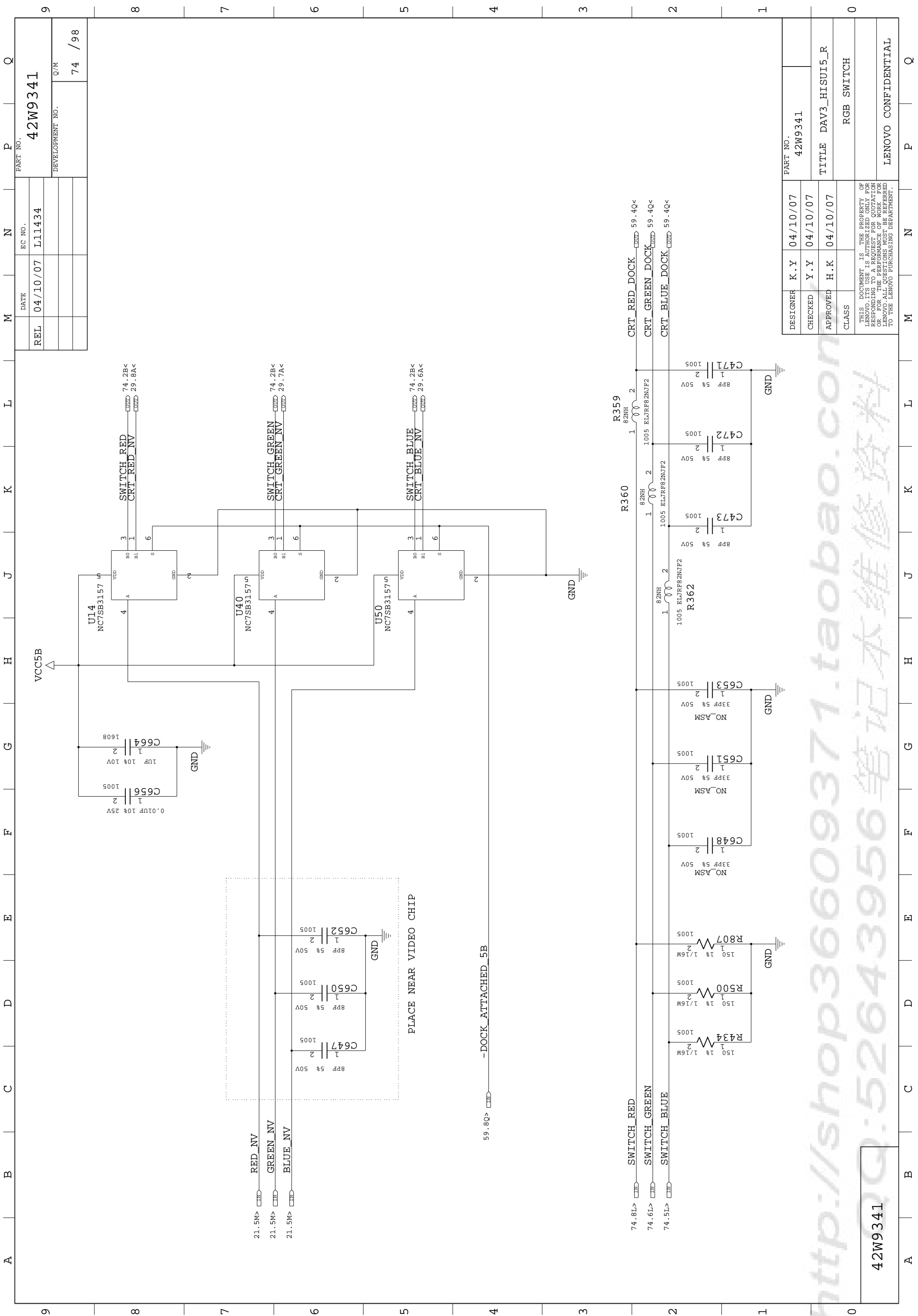

REL	DATE	EC NO.	PART NO.
	04/10/07	L11434	42W9341
			DEVELOPMENT NO.
			74 / 98

DESIGNER	K.Y	04/10/07	PART NO.
CHECKED	Y.Y	04/10/07	42W9341
APPROVED	H.K	04/10/07	TITLE DAV3_HISUI5_R
CLASS			RGB SWITCH

THIS DOCUMENT IS THE PROPERTY OF LENOVO. IT IS LOANED TO YOU FOR REFERENCE ONLY. IT IS NOT TO BE REPRODUCED OR FOR THE PERFORMANCE OF WORK FOR LENOVO. ALL QUESTIONS MUST BE REFERRED TO THE LENOVO PURCHASING DEPARTMENT.

42W9341

http://shop36609371.taobao.com 笔记本维修资料

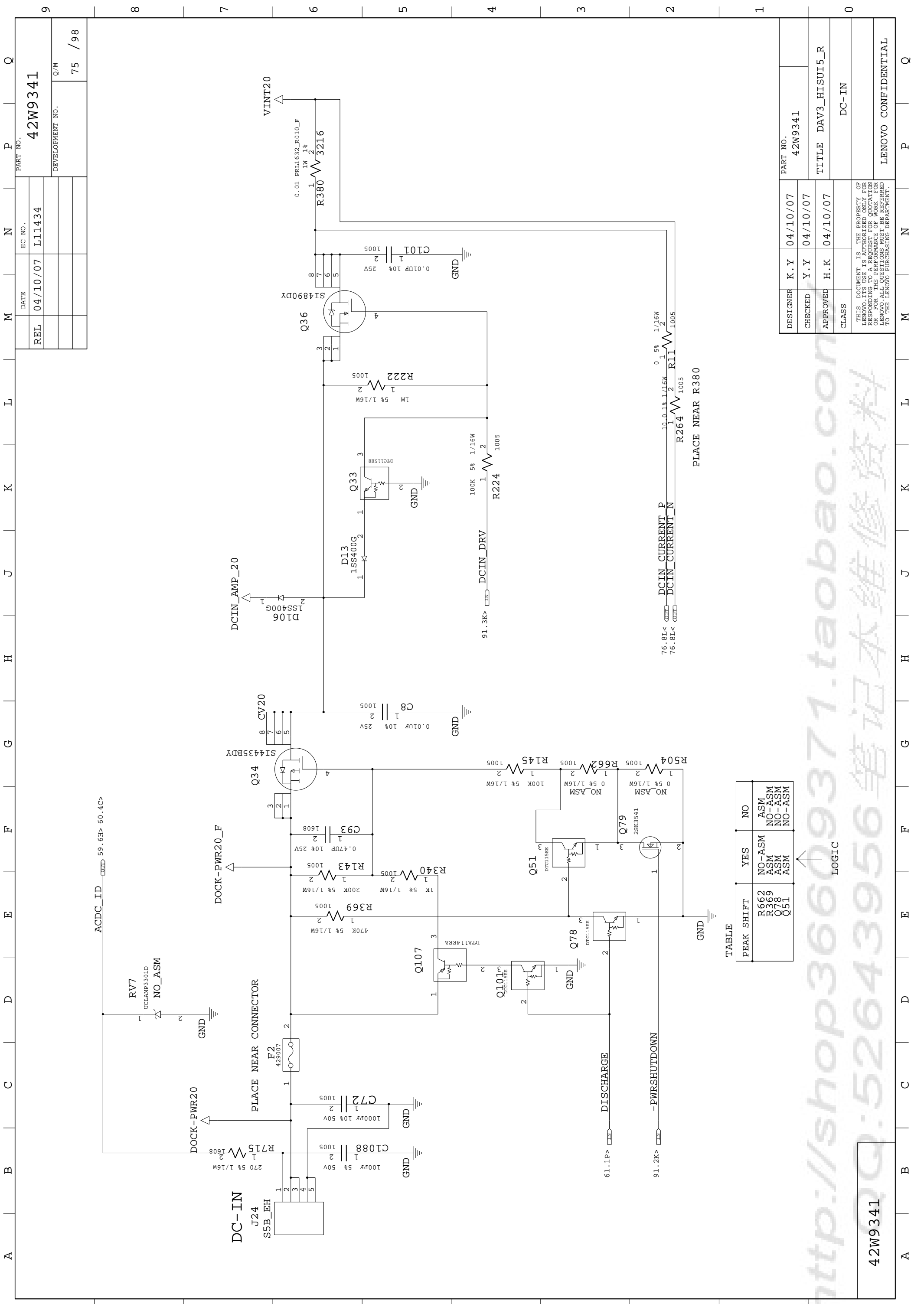

TABLE

PEAK SHIFT	YES	NO
R662	NO-ASM	ASM
R369	NO-ASM	NO-ASM
Q78	ASM	NO-ASM
Q51	ASM	NO-ASM

LOGIC

PLACE NEAR R380

DESIGNER	K.Y	04/10/07	PART NO.	42W9341
CHECKED	Y.Y	04/10/07	TITLE	DAV3_HISUI5_R
APPROVED	H.K	04/10/07	CLASS	DC-IN
THIS DOCUMENT IS THE PROPERTY OF LENOVO. IT IS LOANED TO YOU FOR YOUR USE ONLY. IT IS NOT TO BE REPRODUCED OR TRANSMITTED IN ANY FORM OR BY ANY MEANS, ELECTRONIC OR MECHANICAL, INCLUDING PHOTOCOPYING, RECORDING, OR BY ANY INFORMATION STORAGE AND RETRIEVAL SYSTEM. FOR MORE INFORMATION, CONTACT YOUR LENOVO PURCHASING DEPARTMENT.				

42W9341

http://shop36609371.taobao.com 笔记本维修资料



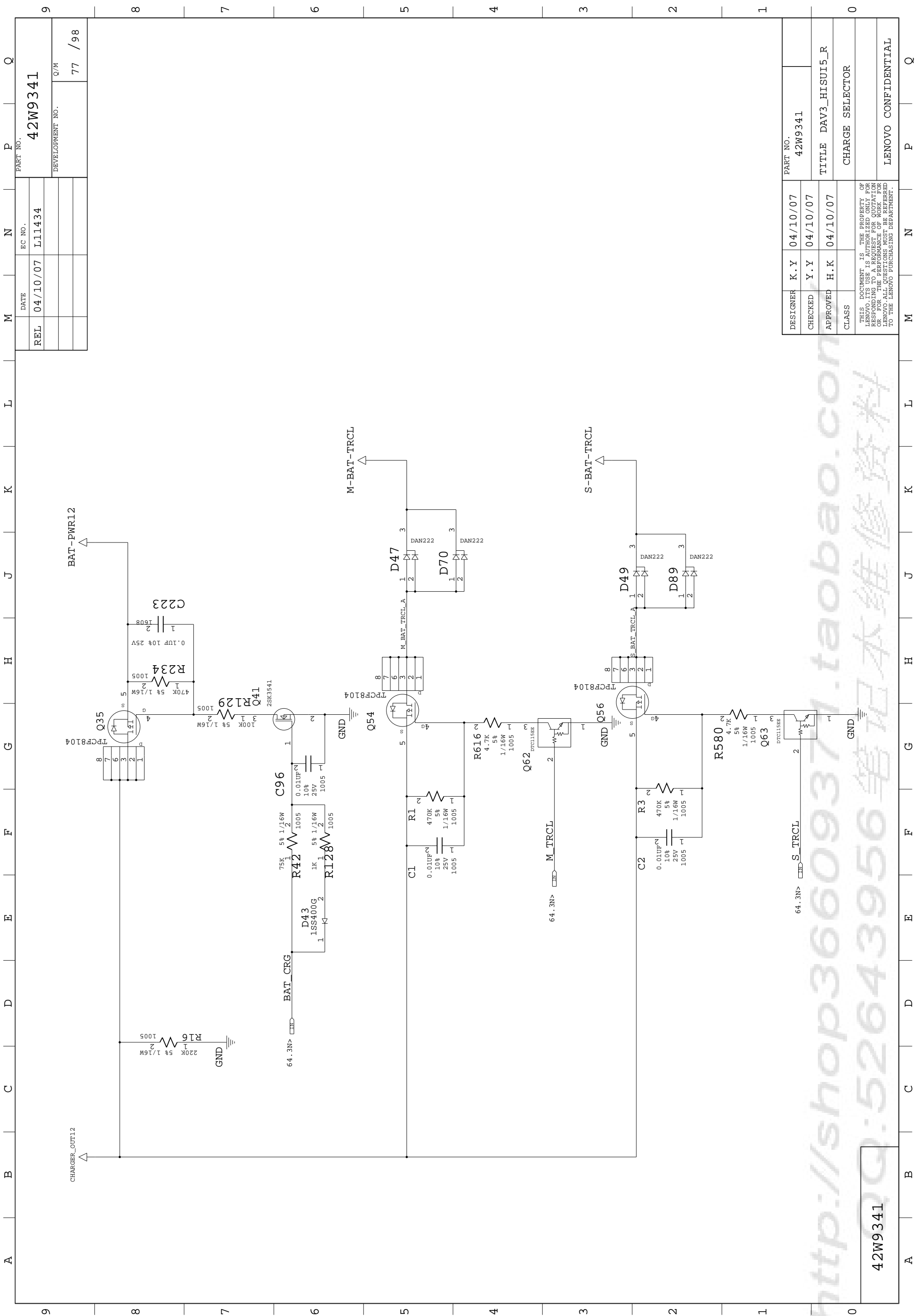

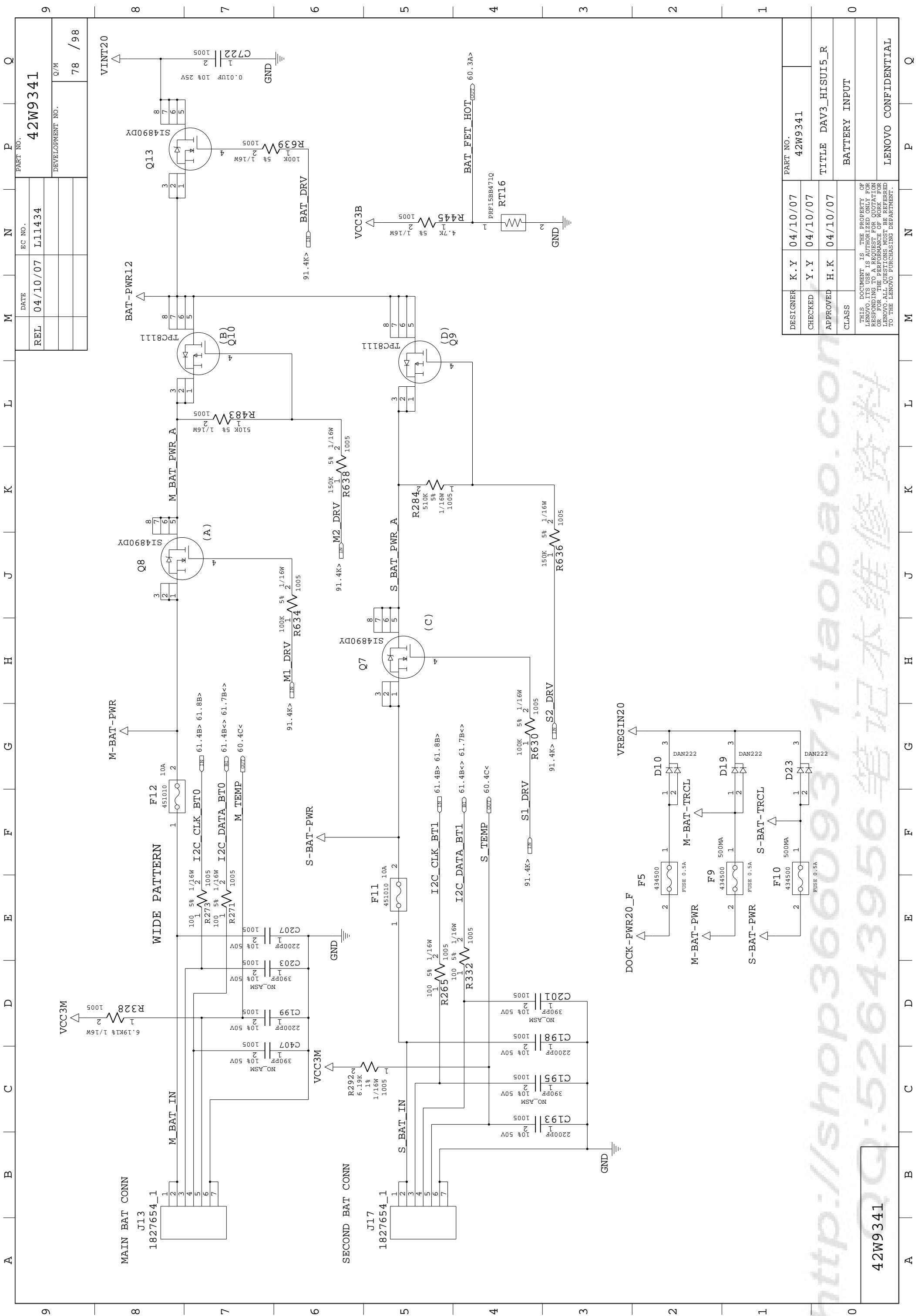

DESIGNER	K.Y	04/10/07	PART NO.	42W9341
CHECKED	Y.Y	04/10/07	TITLE	DAV3_HISUI5_R
APPROVED	H.K	04/10/07	BATTERY INPUT	
CLASS				

THIS DOCUMENT IS THE PROPERTY OF LENOVO. IT IS LOANED TO YOU FOR USE ONLY. IT IS NOT TO BE REPRODUCED OR TRANSMITTED IN ANY FORM OR BY ANY MEANS, ELECTRONIC OR MECHANICAL, INCLUDING PHOTOCOPYING, RECORDING, OR BY ANY INFORMATION STORAGE AND RETRIEVAL SYSTEM. ALL RIGHTS ARE RESERVED. FOR MORE INFORMATION, CONTACT YOUR LOCAL LENOVO OFFICE. ALL QUESTIONS MUST BE REFERRED TO THE LENOVO PURCHASING DEPARTMENT.

http://shop36609371.taobao.com 笔记本维修资料

42W9341

9	A	B	C	D	E	F	G	H	J	K	L	M	N	P	Q
												REL	DATE	EC NO.	PART NO.
												04/10/07	L11434		42W9341
															DEVELOPMENT NO.
															79 / 98

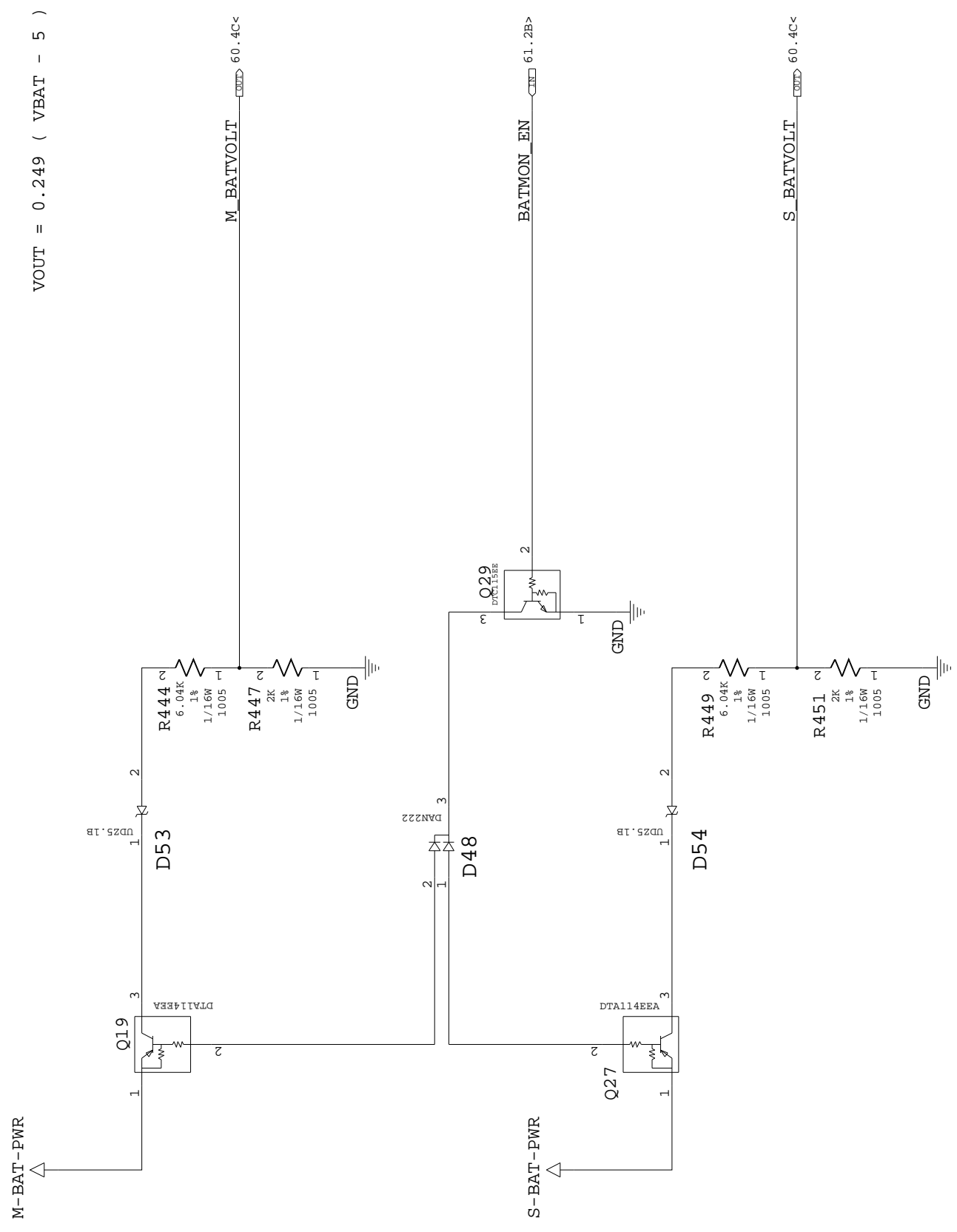

DESIGNER	K.Y	04/10/07	PART NO.	42W9341
CHECKED	Y.Y	04/10/07	TITLE	DAV3_HISUI5_R
APPROVED	H.K	04/10/07	CLASS	BATTERY MONITOR
THIS DOCUMENT IS THE PROPERTY OF LENOVO. IT IS LOANED TO YOU FOR USE ONLY. IT IS NOT TO BE REPRODUCED OR TRANSMITTED IN ANY FORM OR BY ANY MEANS, ELECTRONIC OR MECHANICAL, INCLUDING PHOTOCOPYING, RECORDING, OR BY ANY INFORMATION STORAGE AND RETRIEVAL SYSTEM. WITHOUT PERMISSION IN WRITING FROM LENOVO, ALL QUESTIONS MUST BE REFERRED TO THE LENOVO PURCHASING DEPARTMENT.				

http://shop36609371.taobao.com 笔记本维修资料

42W9341

9	A	B	C	D	E	F	G	H	J	K	L	M	N	P	Q
---	---	---	---	---	---	---	---	---	---	---	---	---	---	---	---

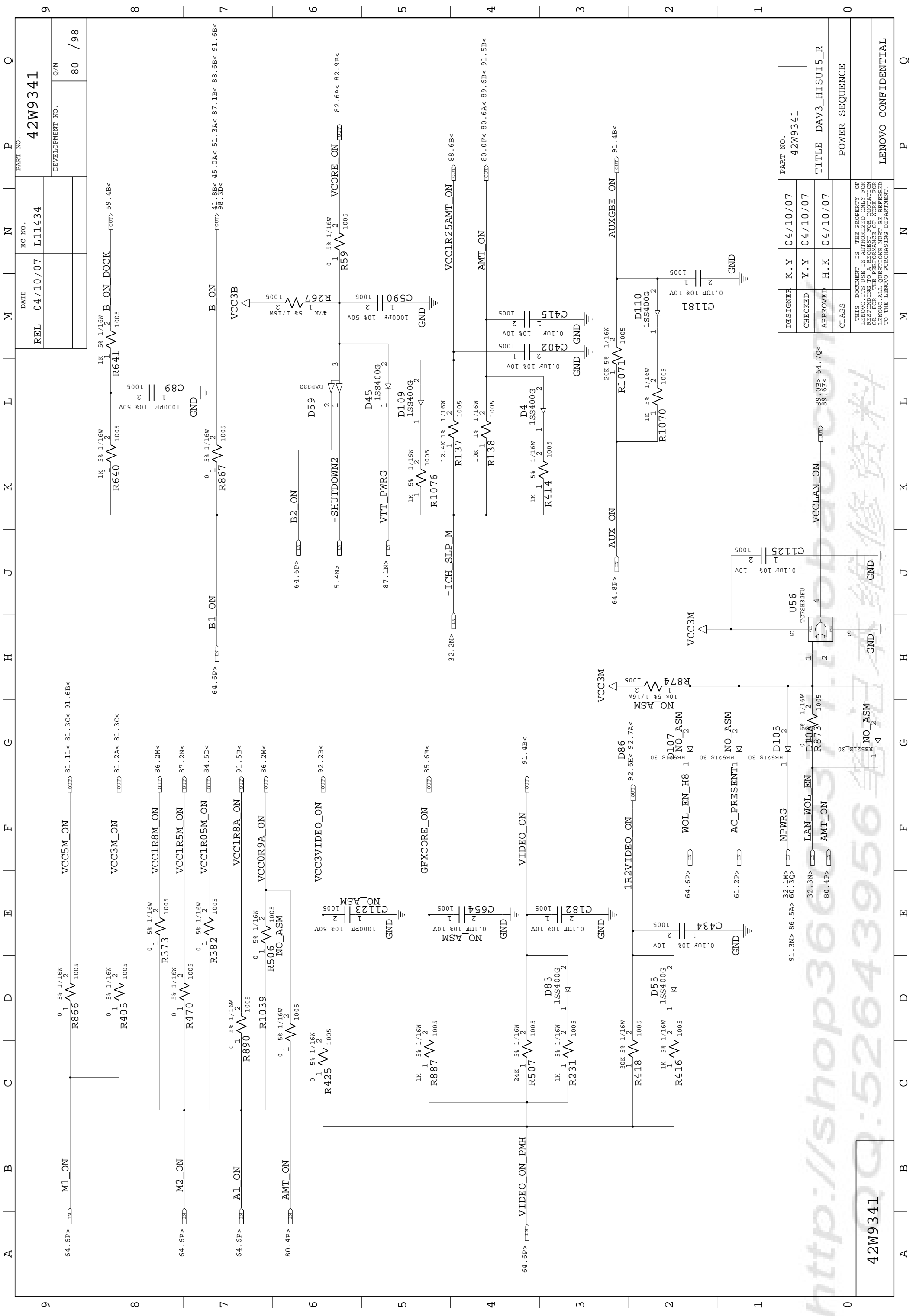

REL	DATE	EC NO.	PART NO.
	04/10/07	L11434	42W9341
DEVELOPMENT NO.			Q/M
			80 / 98

DESIGNER	K.Y	04/10/07	PART NO.	42W9341
CHECKED	Y.Y	04/10/07	TITLE	DAV3_HISUI5_R
APPROVED	H.K	04/10/07	CLASS	POWER SEQUENCE
THIS DOCUMENT IS THE PROPERTY OF LENOVO. IT IS LOANED TO YOU FOR USE ONLY. IT IS NOT TO BE REPRODUCED OR TRANSMITTED IN ANY FORM OR BY ANY MEANS, ELECTRONIC OR MECHANICAL, INCLUDING PHOTOCOPYING, RECORDING, OR BY ANY INFORMATION STORAGE AND RETRIEVAL SYSTEM. ALL RIGHTS RESERVED. FOR MORE INFORMATION, CONTACT YOUR LENOVO ACCOUNT MANAGER OR THE LENOVO PURCHASING DEPARTMENT.				

88.8B> 64.70<	88.8B> 64.70<	88.8B> 64.70<	88.8B> 64.70<	88.8B> 64.70<
VCC3M	VCC3M	VCC3M	VCC3M	VCC3M
VCCCLAN_ON	VCCCLAN_ON	VCCCLAN_ON	VCCCLAN_ON	VCCCLAN_ON
AUX_ON	AUX_ON	AUX_ON	AUX_ON	AUX_ON
AUXGBE_ON	AUXGBE_ON	AUXGBE_ON	AUXGBE_ON	AUXGBE_ON
AMT_ON	AMT_ON	AMT_ON	AMT_ON	AMT_ON
VIDEO_ON	VIDEO_ON	VIDEO_ON	VIDEO_ON	VIDEO_ON
VIDEO_ON_PMH	VIDEO_ON_PMH	VIDEO_ON_PMH	VIDEO_ON_PMH	VIDEO_ON_PMH
GFXCORE_ON	GFXCORE_ON	GFXCORE_ON	GFXCORE_ON	GFXCORE_ON
VCC3VIDEO_ON	VCC3VIDEO_ON	VCC3VIDEO_ON	VCC3VIDEO_ON	VCC3VIDEO_ON
VCC0R9A_ON	VCC0R9A_ON	VCC0R9A_ON	VCC0R9A_ON	VCC0R9A_ON
VCC1R8A_ON	VCC1R8A_ON	VCC1R8A_ON	VCC1R8A_ON	VCC1R8A_ON
VCC1R05M_ON	VCC1R05M_ON	VCC1R05M_ON	VCC1R05M_ON	VCC1R05M_ON
VCC1R5M_ON	VCC1R5M_ON	VCC1R5M_ON	VCC1R5M_ON	VCC1R5M_ON
VCC1R8M_ON	VCC1R8M_ON	VCC1R8M_ON	VCC1R8M_ON	VCC1R8M_ON
VCC3M_ON	VCC3M_ON	VCC3M_ON	VCC3M_ON	VCC3M_ON
VCC5M_ON	VCC5M_ON	VCC5M_ON	VCC5M_ON	VCC5M_ON
AMT_ON	AMT_ON	AMT_ON	AMT_ON	AMT_ON
A1_ON	A1_ON	A1_ON	A1_ON	A1_ON
M2_ON	M2_ON	M2_ON	M2_ON	M2_ON
M1_ON	M1_ON	M1_ON	M1_ON	M1_ON
B1_ON	B1_ON	B1_ON	B1_ON	B1_ON
B2_ON	B2_ON	B2_ON	B2_ON	B2_ON
B_ON	B_ON	B_ON	B_ON	B_ON
VCORE_ON	VCORE_ON	VCORE_ON	VCORE_ON	VCORE_ON
VCORE_ON	VCORE_ON	VCORE_ON	VCORE_ON	VCORE_ON
82.6A< 82.9B<	82.6A< 82.9B<	82.6A< 82.9B<	82.6A< 82.9B<	82.6A< 82.9B<

http://shop36609371.taobao.com 52643956

42W9341



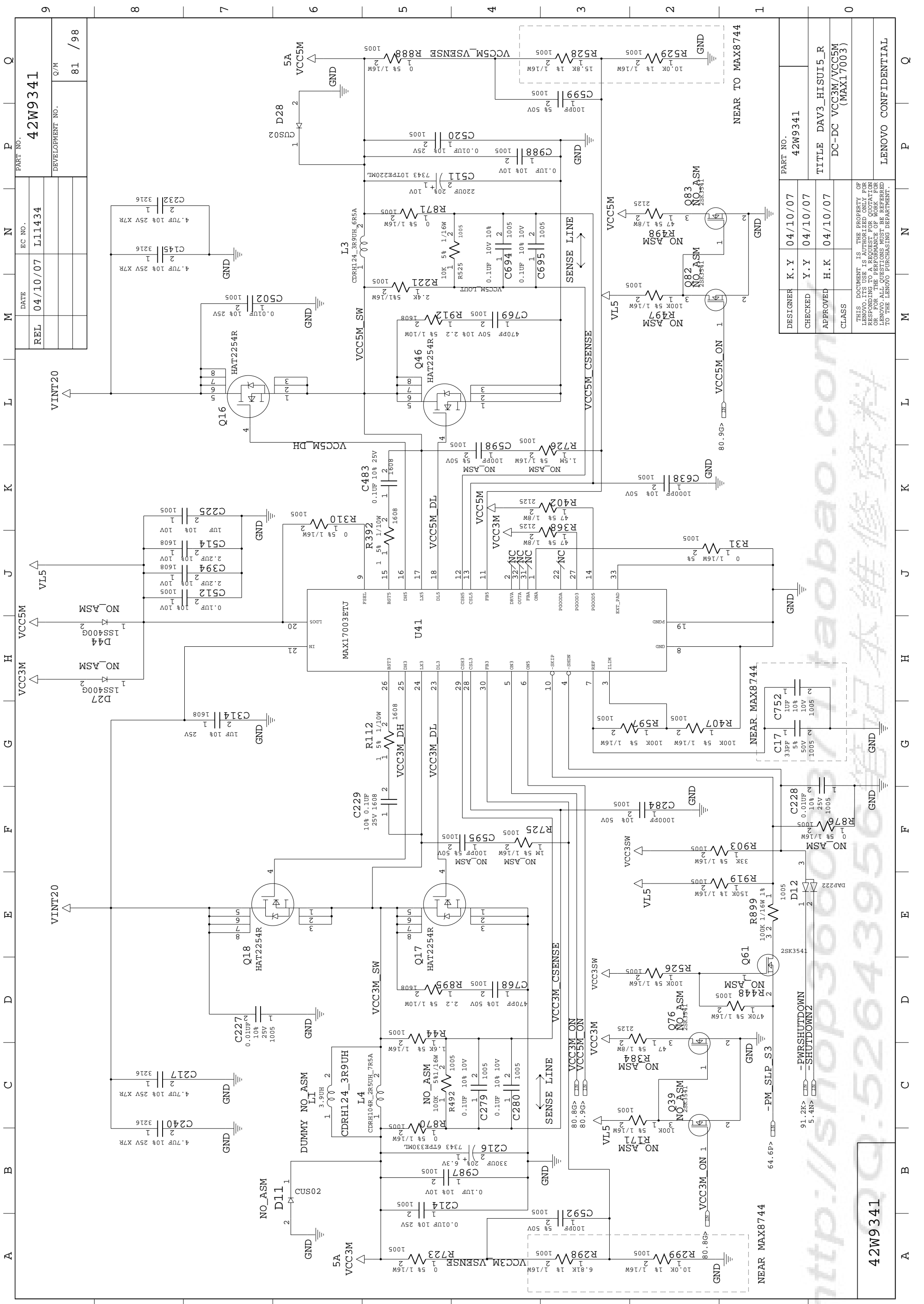

REL	DATE	EC NO.	PART NO.
	04/10/07	L11434	42W9341
			DEVELOPMENT NO.
			Q/M
			81 / 98

DESIGNER	K. Y	04/10/07	PART NO.	42W9341
CHECKED	Y. Y	04/10/07	TITLE	DAV3_HISUI5_R
APPROVED	H. K	04/10/07	DC-DC	VCC3M/VCC5M (MAX17003)
CLASS				

THIS DOCUMENT IS THE PROPERTY OF LENOVO. IT IS LOANED TO YOU FOR USE ONLY. IT IS NOT TO BE REPRODUCED OR TRANSMITTED IN ANY FORM OR BY ANY MEANS, ELECTRONIC OR MECHANICAL, INCLUDING PHOTOCOPYING, RECORDING, OR BY ANY INFORMATION STORAGE AND RETRIEVAL SYSTEM. FOR MORE INFORMATION, CONTACT YOUR LENOVO ACCOUNT MANAGER OR THE LENOVO PURCHASING DEPARTMENT.

http://shop36609371.taobao.com 笔记本维修资料

42W9341

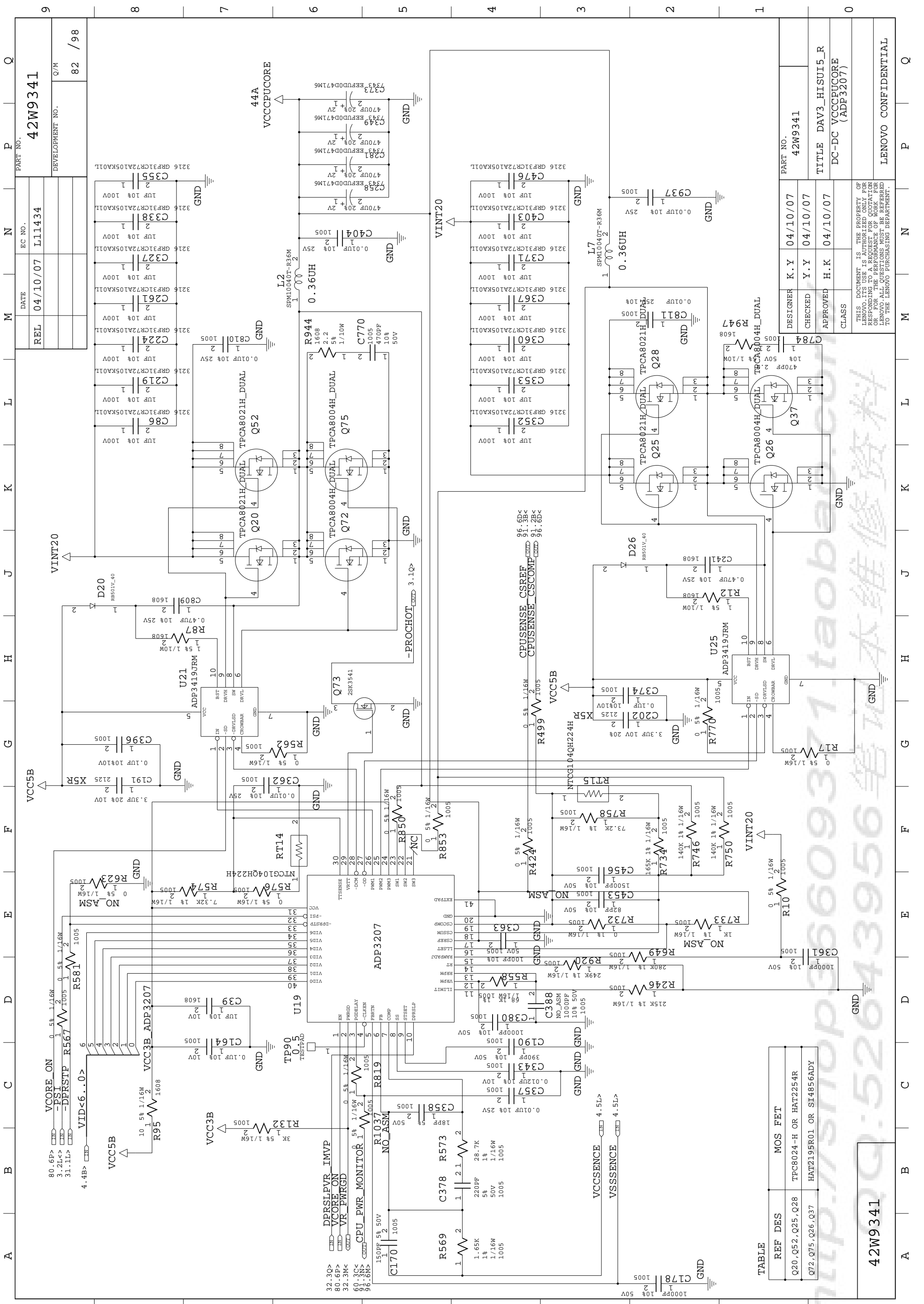

REF DES	MOS FET
Q20, Q25, Q28	TPC8024-H OR HAT2254R
Q72, Q75, Q26, Q37	HAT2195R01 OR SI4856ADY

DESIGNER	CHECKED	APPROVED	CLASS
K.Y	Y.Y	H.K	

DATE	DESIGNER	CHECKED	APPROVED	CLASS
04/10/07	K.Y	Y.Y	H.K	

THIS DOCUMENT IS THE PROPERTY OF LENOVO. IT IS LOANED TO YOU BY LENOVO. IT IS NOT TO BE REPRODUCED OR TRANSMITTED IN ANY FORM OR BY ANY MEANS, ELECTRONIC OR MECHANICAL, INCLUDING PHOTOCOPYING, RECORDING, OR BY ANY INFORMATION STORAGE AND RETRIEVAL SYSTEM. ALL RIGHTS ARE RESERVED. FOR MORE INFORMATION, CONTACT YOUR LENOVO ACCOUNT MANAGER. LENOVO-ALL QUESTIONS MUST BE REFERRED TO THE LENOVO PURCHASING DEPARTMENT.

42W9341

DC-DC VCC5BUCORE (ADP3207)

REL 04/10/07 L11434 42W9341

DATE 04/10/07 L11434 42W9341

DEVELOPMENT NO. Q/M 82 / 98

9 8 7 6 5 4 3 2 1 0

A B C D E F G H J K L M N P Q

A	B	C	D	E	F	G	H	J	K	L	M	N	P	Q
REL 04/10/07 L11434												PART NO. 42W9341		
DATE 04/10/07												EC NO. L11434		
DEVELOPMENT NO.												Q/M 83 / 98		

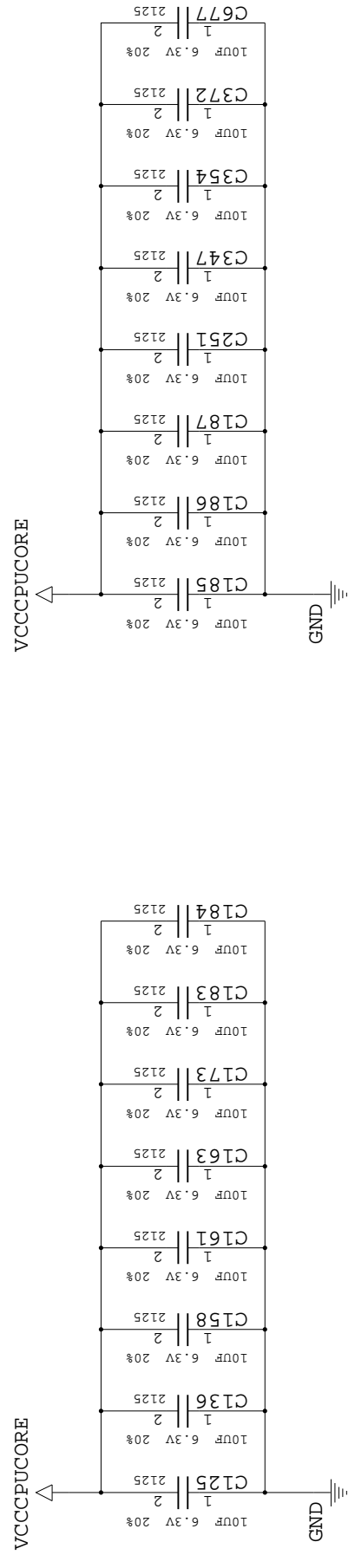

10UF 6.3V X5R 2125 1/16W X 16PCS

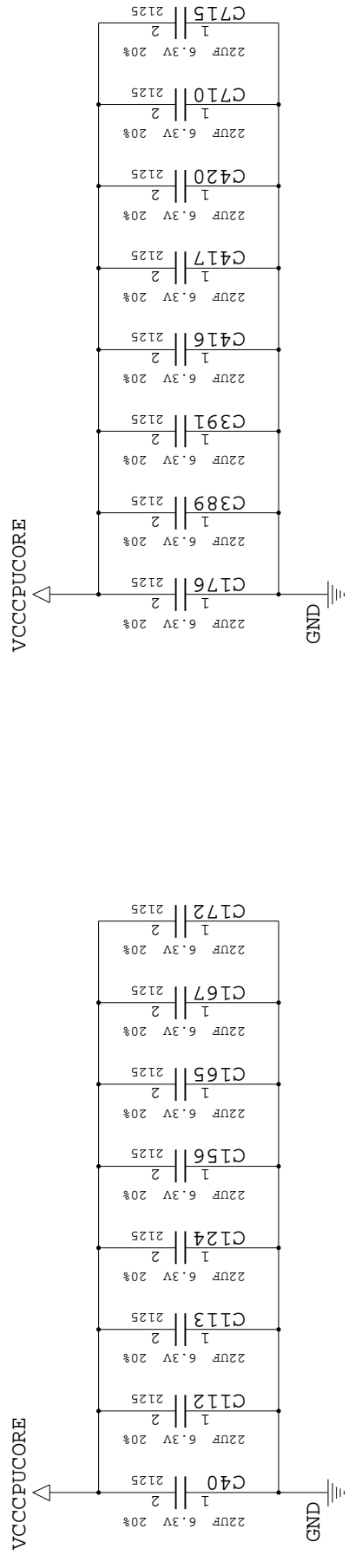

22UF 6.3V X5R 2125 1/16W X 16PCS

DESIGNER	K.Y	04/10/07	PART NO.	42W9341
CHECKED	Y.Y	04/10/07	TITLE	DAV3_HISUI5_R
APPROVED	H.K	04/10/07	CLASS	VCCPUCORE DECOUPLING
THIS DOCUMENT IS THE PROPERTY OF LENOVO. IT IS LOANED TO YOU FOR USE ONLY. IT IS NOT TO BE REPRODUCED OR TRANSMITTED IN ANY FORM OR BY ANY MEANS, ELECTRONIC OR MECHANICAL, INCLUDING PHOTOCOPYING, RECORDING, OR BY ANY INFORMATION STORAGE AND RETRIEVAL SYSTEM. WITHOUT PERMISSION IN WRITING FROM LENOVO, ALL QUESTIONS MUST BE REFERRED TO THE LENOVO PURCHASING DEPARTMENT.				
LENOVO CONFIDENTIAL				

42W9341

http://shop36609371.taobao.com 笔记本维修资料

M	N	P	Q
REL	DATE	EC NO.	PART NO.
	04/10/07	L11434	42W9341
			DEVELOPMENT NO.
			Q/M
			84 / 98

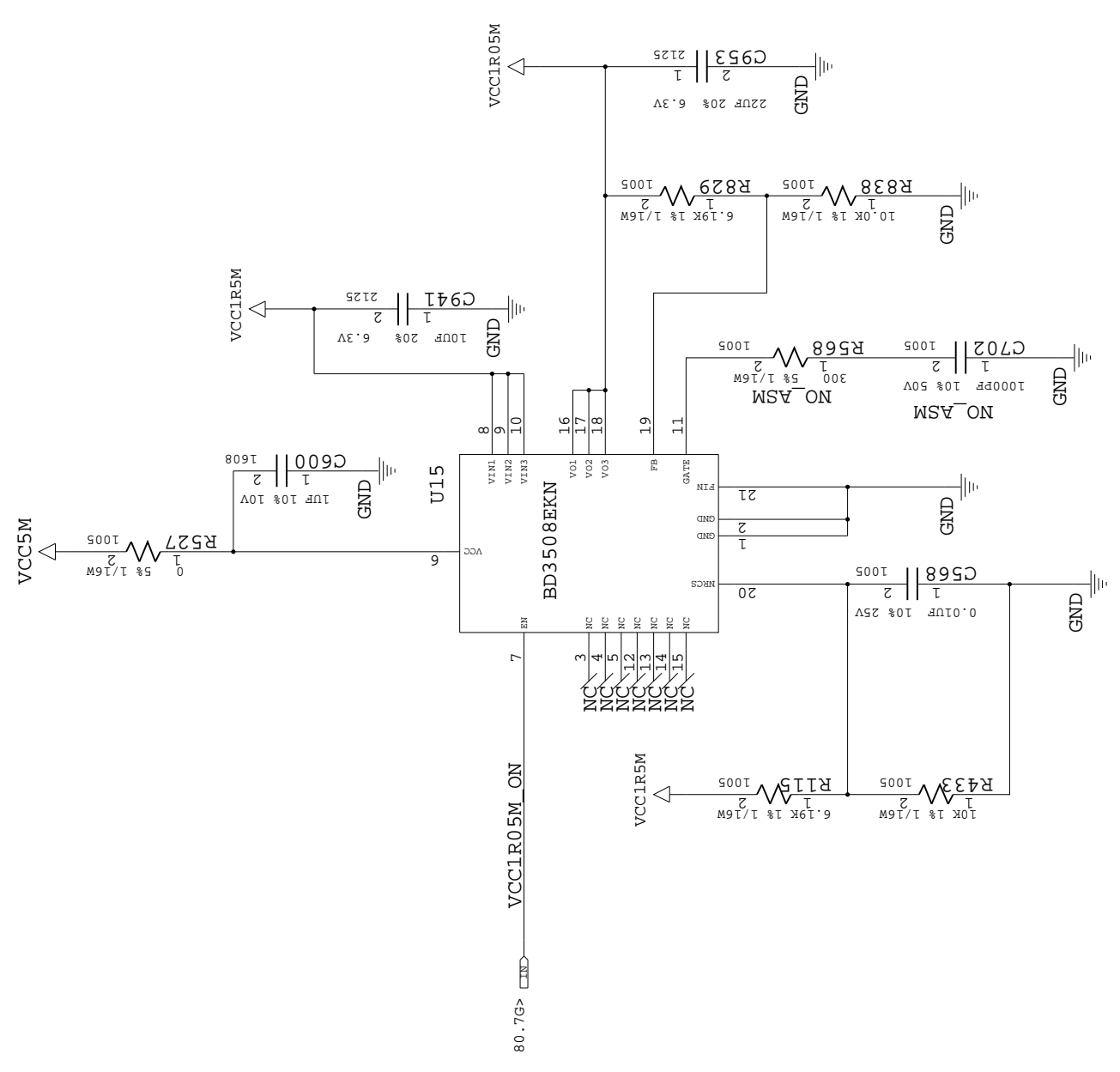

DESIGNER	K. Y	04/10/07	PART NO.	42W9341
CHECKED	Y. Y	04/10/07	TITLE	DAV3_HISUI5_R
APPROVED	H. K	04/10/07	CLASS	DC-DC VCC1R05M
THIS DOCUMENT IS THE PROPERTY OF LENOVO. IT IS LOANED TO YOU FOR REFERENCE ONLY. YOU ARE NOT TO REPRODUCE, COPY, OR TRANSMIT THIS DOCUMENT OR ANY PART THEREOF WITHOUT THE WRITTEN PERMISSION OF LENOVO. ALL QUESTIONS MUST BE REFERRED TO THE LENOVO PURCHASING DEPARTMENT.				

42W9341

http://shop36609371.taobao.com 笔记本维修资料

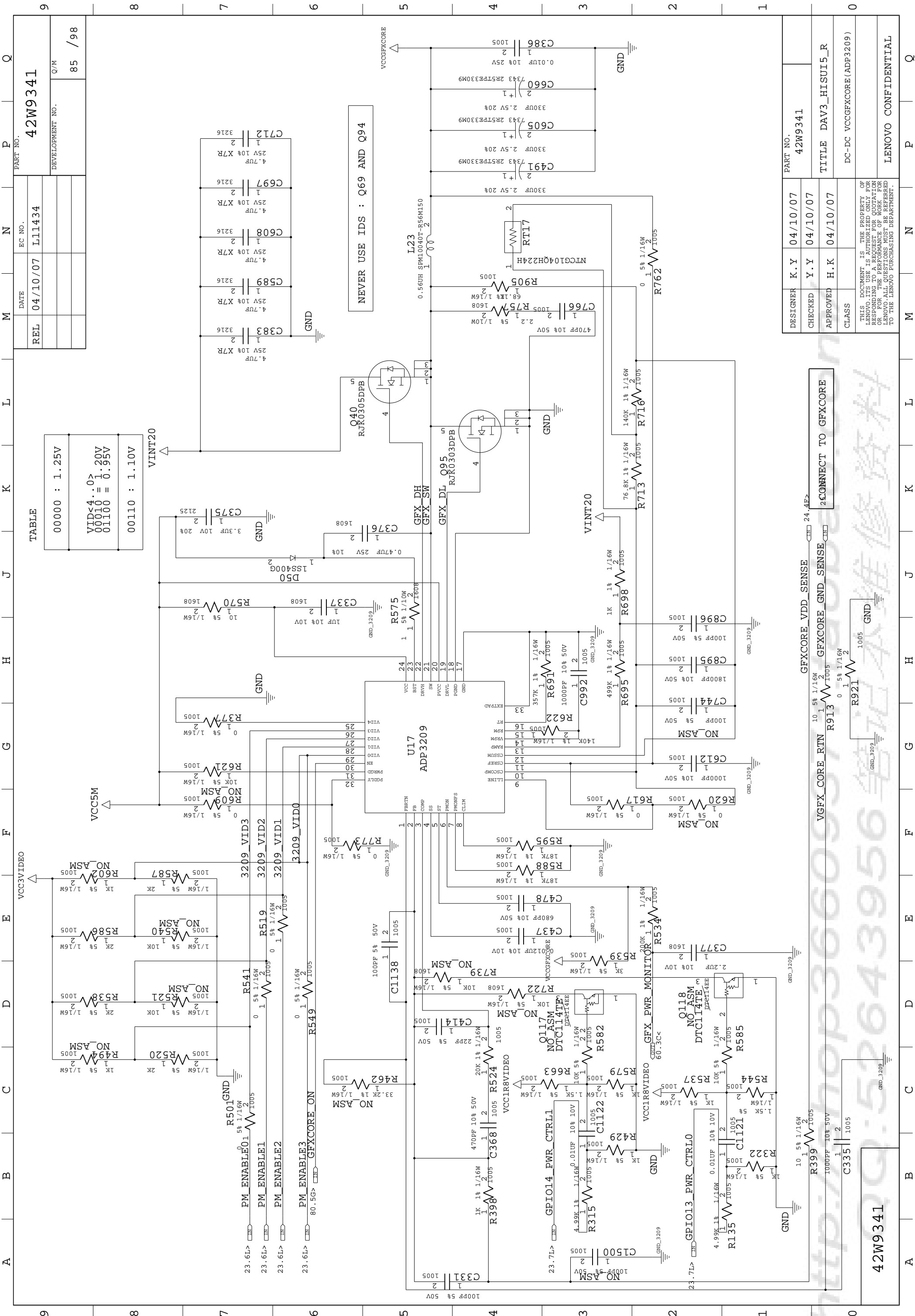

TABLE

00000 : 1.25V  
VID<4..0> = 1.20V  
00010 = 1.20V  
01100 = 0.95V  
00110 : 1.10V

DESIGNER	K.Y	04/10/07
CHECKED	Y.Y	04/10/07
APPROVED	H.K	04/10/07
CLASS		
PART NO.		42W9341
TITLE		DAV3_HISUI5_R
CLASS		DC-DC VCCGFXCORE(ADP3209)

42W9341

CONNECT TO GFXCORE

GFXCORE\_VDD Sense 24.4F2

VGFX\_CORE\_RTN 10 5% 1/16W R913

NO ASM

NEVER USE IDS : Q69 AND Q94

CONNECT TO GFXCORE

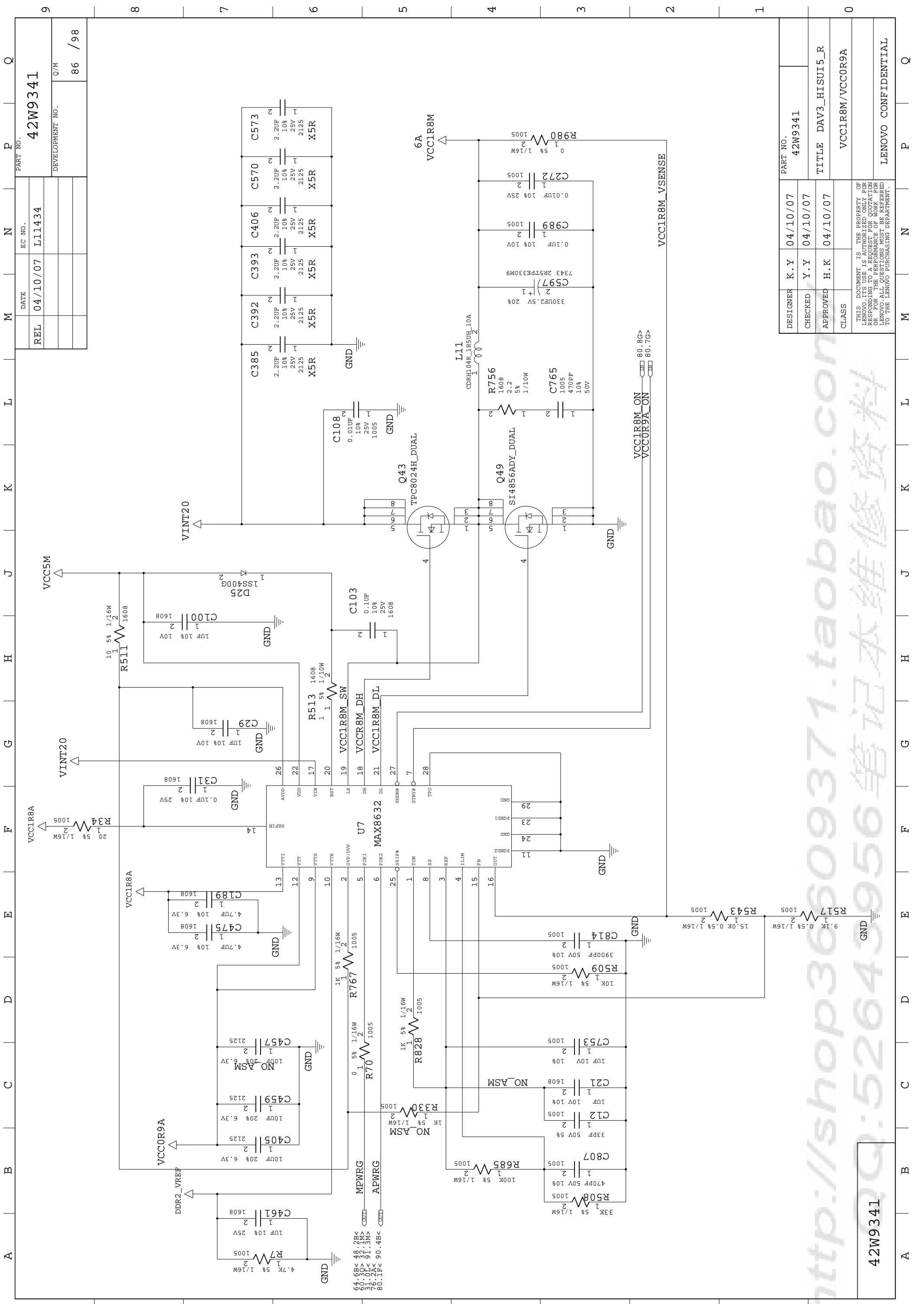

REL	DATE	EC NO.	PART NO.
	04/10/07	L11434	42W9341
			DEVELOPMENT NO.
			Q/M
			86 / 98

DESIGNER	K.Y	04/10/07	PART NO.	42W9341
CHECKED	Y.Y	04/10/07	TITLE	DAV3_HISUI5_R
APPROVED	H.K	04/10/07		VCC1R8M/VCC0R9A
CLASS				

42W9341

THIS DOCUMENT IS THE PROPERTY OF  
LENOVO. IT IS LOANED TO YOU FOR USE  
ONLY IN CONNECTION WITH THE WORK  
PERFORMED FOR THE PERFORMANCE OF WORK.  
LENOVO-ALL QUESTIONS MUST BE REFERRED  
TO THE LENOVO PURCHASING DEPARTMENT.

http://shop36609371.taobao.com 笔记本维修资料



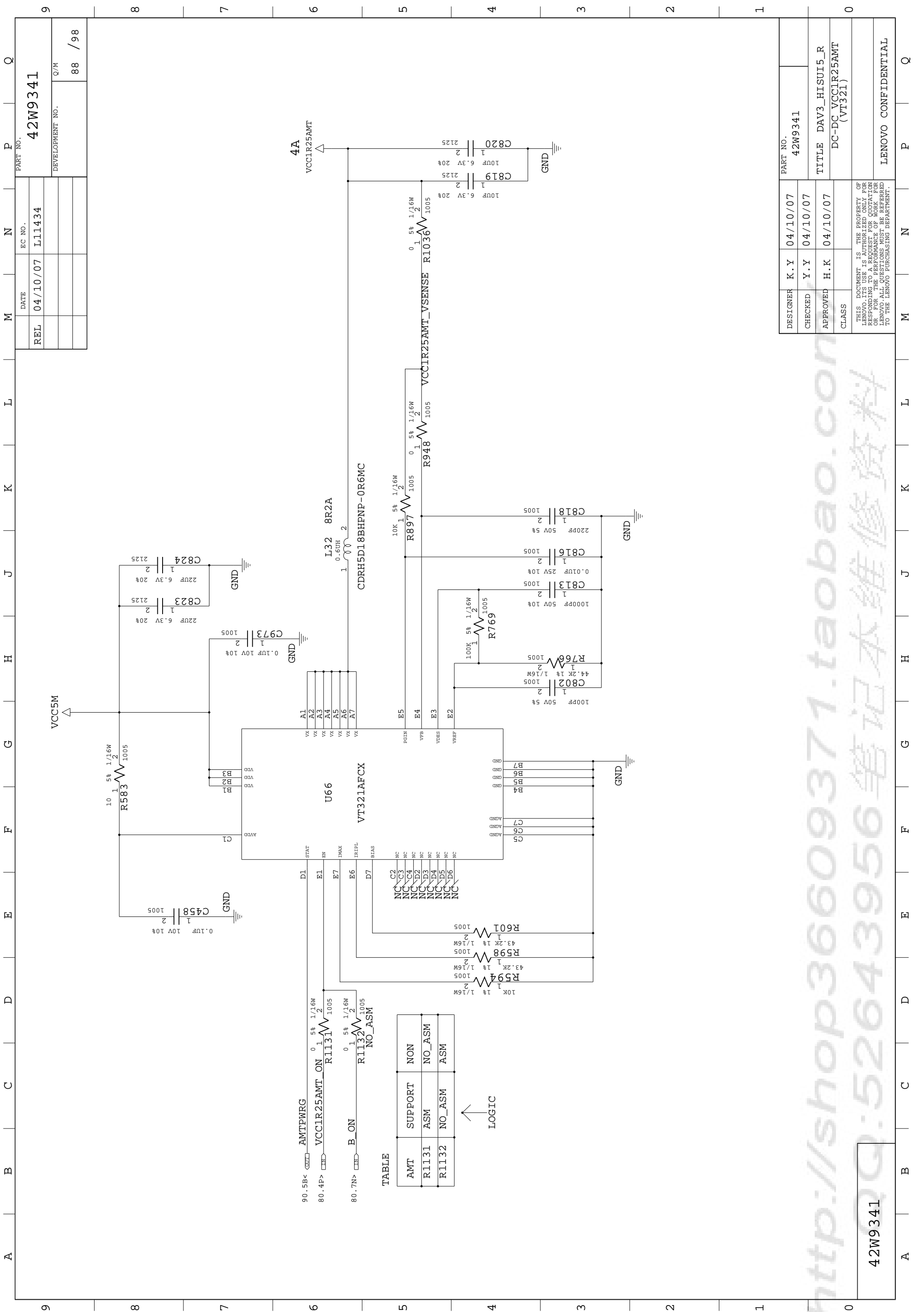

REL	04/10/07	EC NO.	L11434	PART NO.	42W9341
		DATE		DEVELOPMENT NO.	Q/M
					88 / 98

DESIGNER	K.Y	04/10/07	PART NO.	42W9341
CHECKED	Y.Y	04/10/07	TITLE	DAV3_HISUI5_R
APPROVED	H.K	04/10/07		DC-DC VCC1R25AMT (VT321)
CLASS				

THIS DOCUMENT IS THE PROPERTY OF LENOVO. IT IS LOANED TO YOU FOR USE ONLY. IT IS NOT TO BE REPRODUCED OR TRANSMITTED IN ANY FORM OR BY ANY MEANS, ELECTRONIC OR MECHANICAL, INCLUDING PHOTOCOPYING, RECORDING, OR BY ANY INFORMATION STORAGE AND RETRIEVAL SYSTEM. ALL RIGHTS ARE RESERVED. FOR MORE INFORMATION, CONTACT YOUR LENOVO ACCOUNT MANAGER. ALL QUESTIONS MUST BE REFERRED TO THE LENOVO PURCHASING DEPARTMENT.

http://shop36609371.taobao.com 笔记本维修资料

42W9341



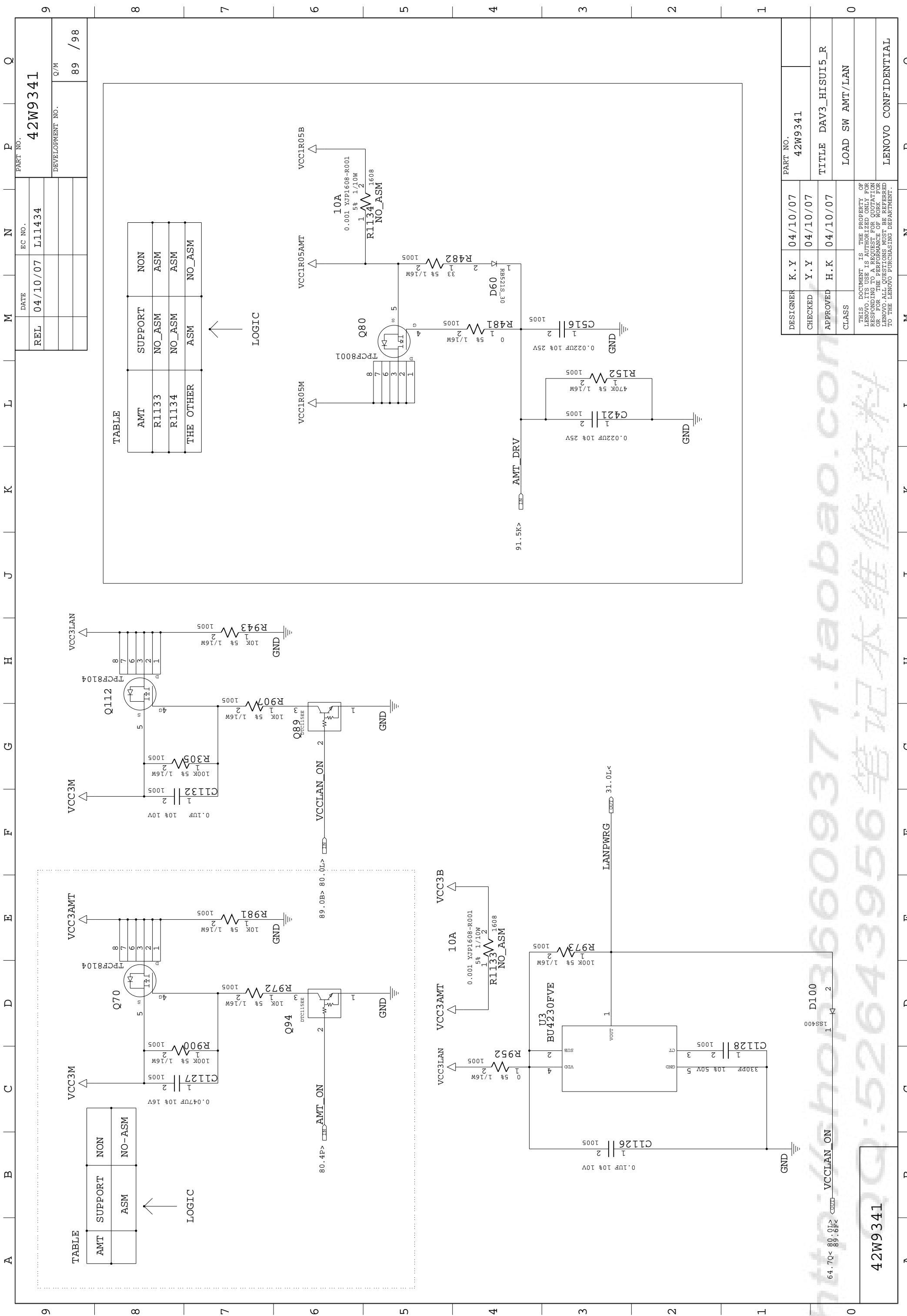

DESIGNER	K.Y	04/10/07	PART NO.	42W9341
CHECKED	Y.Y	04/10/07	TITLE	DAV3_HISUI5_R
APPROVED	H.K	04/10/07	LOAD SW	AMT/LAN
CLASS				

THIS DOCUMENT IS THE PROPERTY OF LENOVO. IT IS LOANED TO YOU FOR USE ONLY. IT IS NOT TO BE REPRODUCED OR TRANSMITTED IN ANY FORM OR BY ANY MEANS, ELECTRONIC OR MECHANICAL, INCLUDING PHOTOCOPYING, RECORDING, OR BY ANY INFORMATION STORAGE AND RETRIEVAL SYSTEM. ALL RIGHTS RESERVED. FOR MORE INFORMATION, CONTACT YOUR LENOVO ACCOUNT MANAGER. LENOVO-ALL QUESTIONS MUST BE REFERRED TO THE LENOVO PURCHASING DEPARTMENT.

<http://shop36609371.taobao.com> 笔记本维修资料  
 64.70 < 89.01 > VCCLEAN\_ON  
 42W9341

9	8	7	6	5	4	3	2	1	0
A	B	C	D	E	F	G	H	J	K
L	M	N	P	Q					
REL		DATE	EC NO.	PART NO.					
04/10/07		04/10/07	L11434	42W9341					
				DEVELOPMENT NO.		Q/M			
				90 / 98					

TABLE

	AMT	NON_AMT
R1051	NO_ASM	ASM
OTHERS	ASM	NO_ASM

↑  
LOGIC

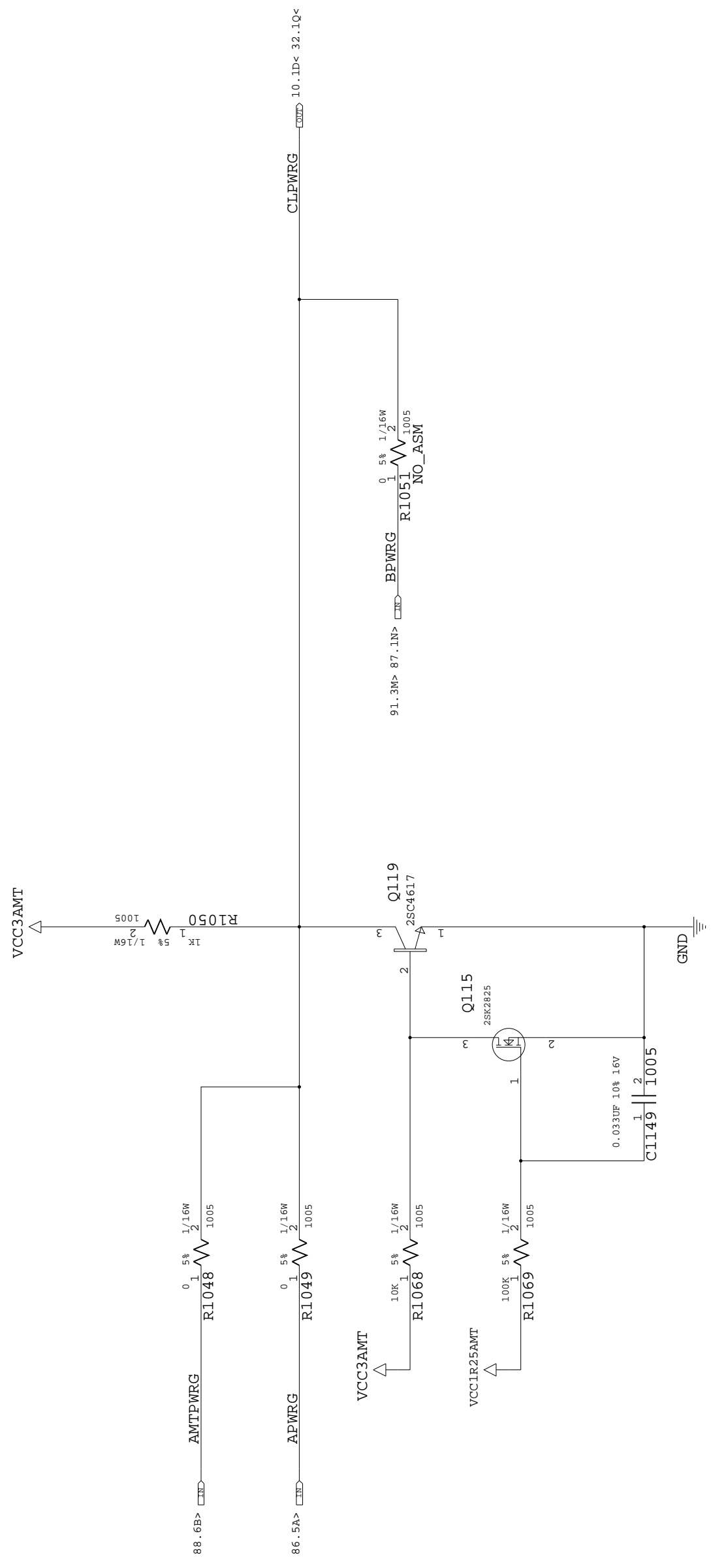

DESIGNER	K.Y	04/10/07	PART NO.	42W9341
CHECKED	Y.Y	04/10/07	TITLE	DAV3_HISUI5_R
APPROVED	H.K	04/10/07	CLASS	CLPWRG
THIS DOCUMENT IS THE PROPERTY OF LENOVO. IT IS LOANED TO YOU FOR YOUR USE ONLY. IT IS NOT TO BE REPRODUCED OR TRANSMITTED IN ANY FORM OR BY ANY MEANS, ELECTRONIC OR MECHANICAL, INCLUDING PHOTOCOPYING, RECORDING, OR BY ANY INFORMATION STORAGE AND RETRIEVAL SYSTEM. FOR MORE INFORMATION, CONTACT YOUR LENOVO ACCOUNT MANAGER OR THE LENOVO PURCHASING DEPARTMENT.				
LENOVO CONFIDENTIAL				

http://shop36609371.taobao.com 笔记本维修资料

42W9341

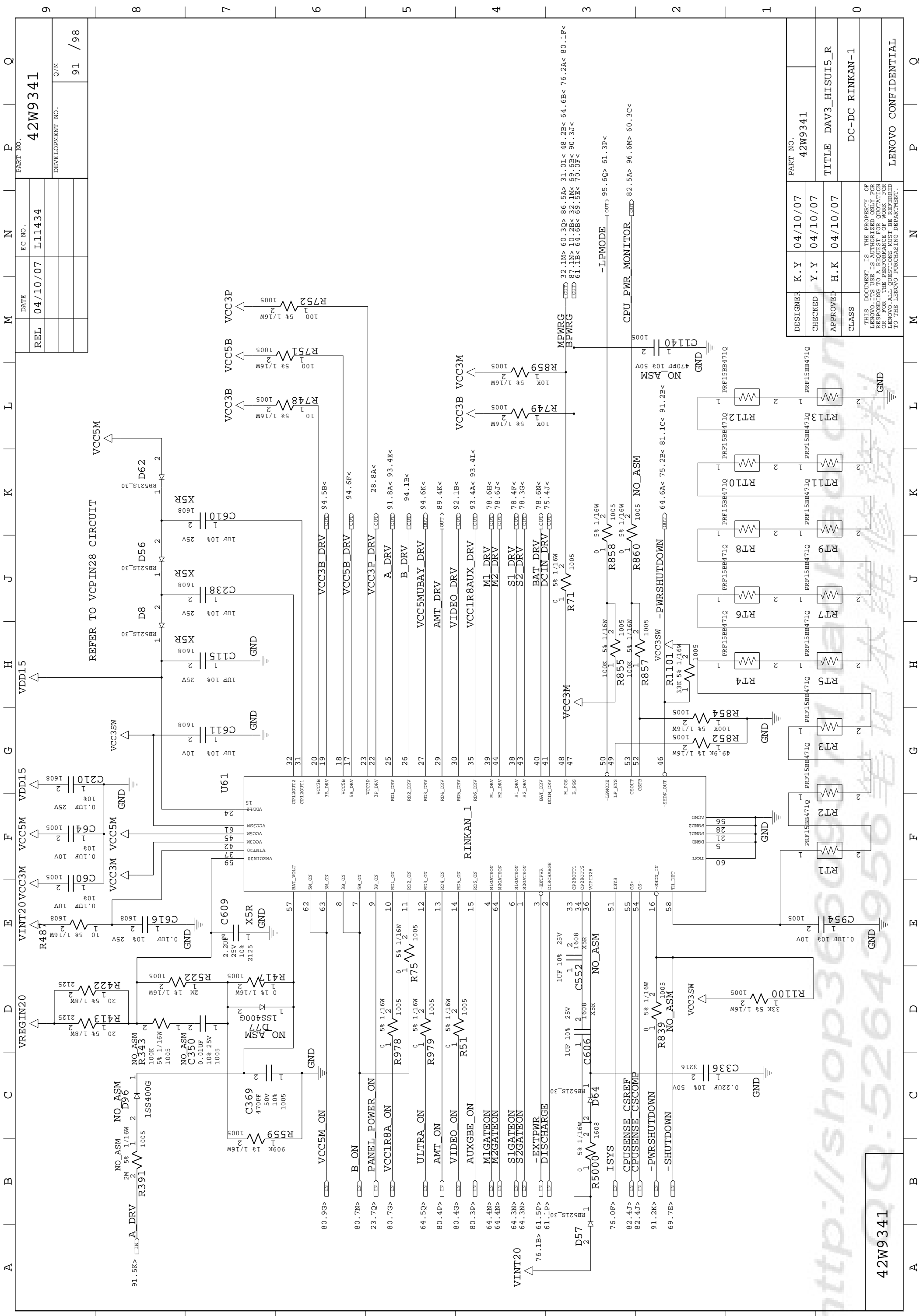

REL	DATE	EC NO.	PART NO.
	04/10/07	L11434	42W9341
			DEVELOPMENT NO.
			Q/M
			91 / 98

DESIGNER	K. Y	04/10/07	PART NO.
CHECKED	Y. Y	04/10/07	42W9341
APPROVED	H. K	04/10/07	TITLE
CLASS			DC-DC RINKAN-1

42W9341

THIS DOCUMENT IS THE PROPERTY OF  
LENOVO. IT IS LOANED TO YOU FOR  
YOUR USE ONLY. IT IS NOT TO BE  
REPRODUCED OR TRANSMITTED IN  
ANY FORM OR BY ANY MEANS, FOR  
OR FOR THE PERFORMANCE OF WORK FOR  
LENOVO. ALL QUESTIONS MUST BE REFERRED  
TO THE LENOVO PURCHASING DEPARTMENT.

LENOVO CONFIDENTIAL

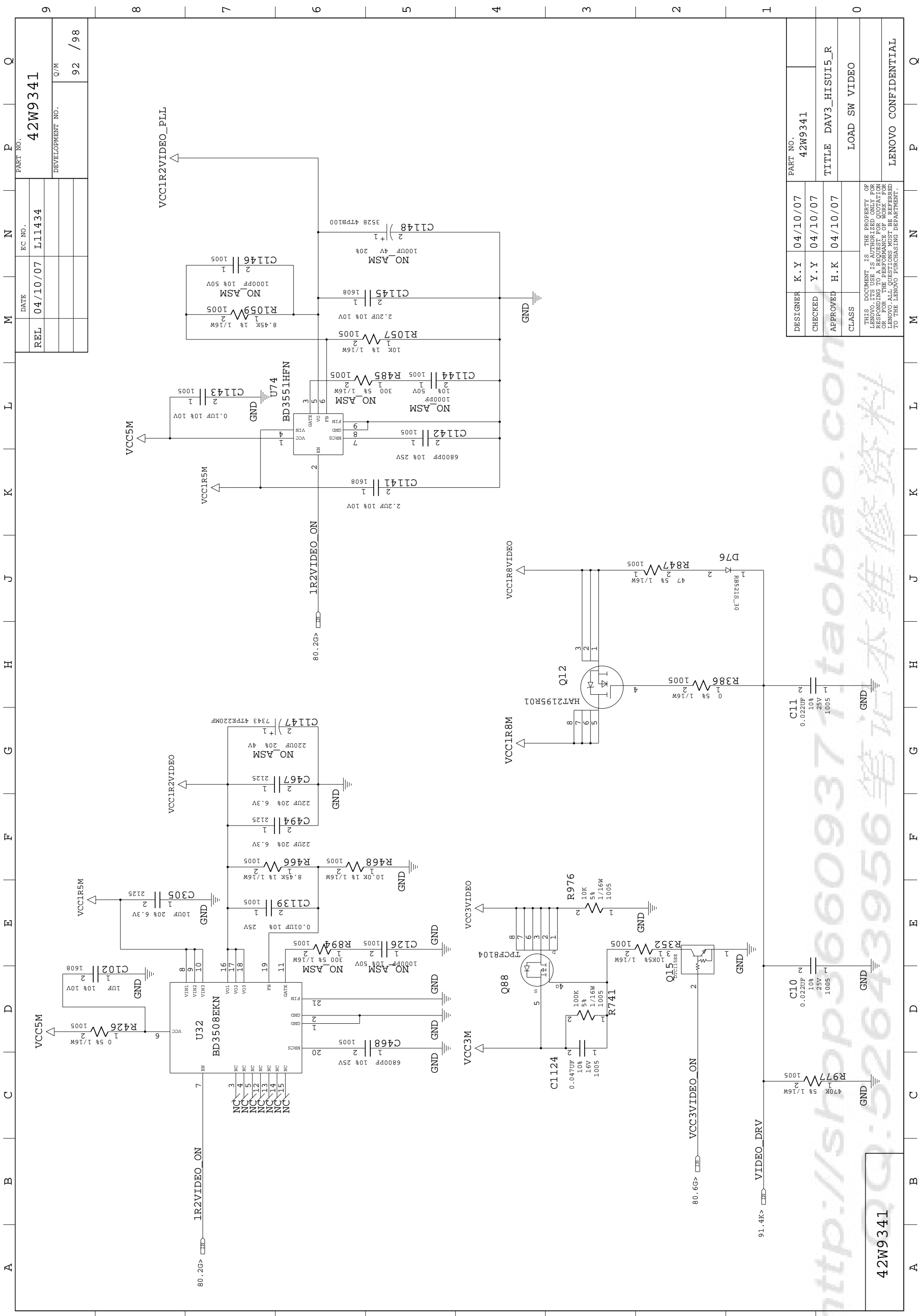

REL	DATE	EC NO.	PART NO.
	04/10/07	L11434	42W9341
			DEVELOPMENT NO.
			Q/M
			92 / 98

DESIGNER	K.Y	04/10/07	PART NO.	42W9341
CHECKED	Y.Y	04/10/07	TITLE	DAV3_HISUI5_R
APPROVED	H.K	04/10/07	CLASS	LOAD SW VIDEO
THIS DOCUMENT IS THE PROPERTY OF LENOVO. IT IS LOANED TO YOU FOR USE ONLY. IT IS NOT TO BE REPRODUCED OR TRANSMITTED IN ANY FORM OR BY ANY MEANS, ELECTRONIC OR MECHANICAL, INCLUDING PHOTOCOPYING, RECORDING, OR BY ANY INFORMATION STORAGE AND RETRIEVAL SYSTEM. ANY UNAUTHORIZED USE, REPRODUCTION, OR TRANSMISSION OF THIS DOCUMENT IS STRICTLY PROHIBITED. ALL RIGHTS ARE RESERVED. FOR MORE INFORMATION, CONTACT YOUR LENOVO PURCHASING DEPARTMENT.				

42W9341

http://shop36609371.taobao.com 笔记本维修资料

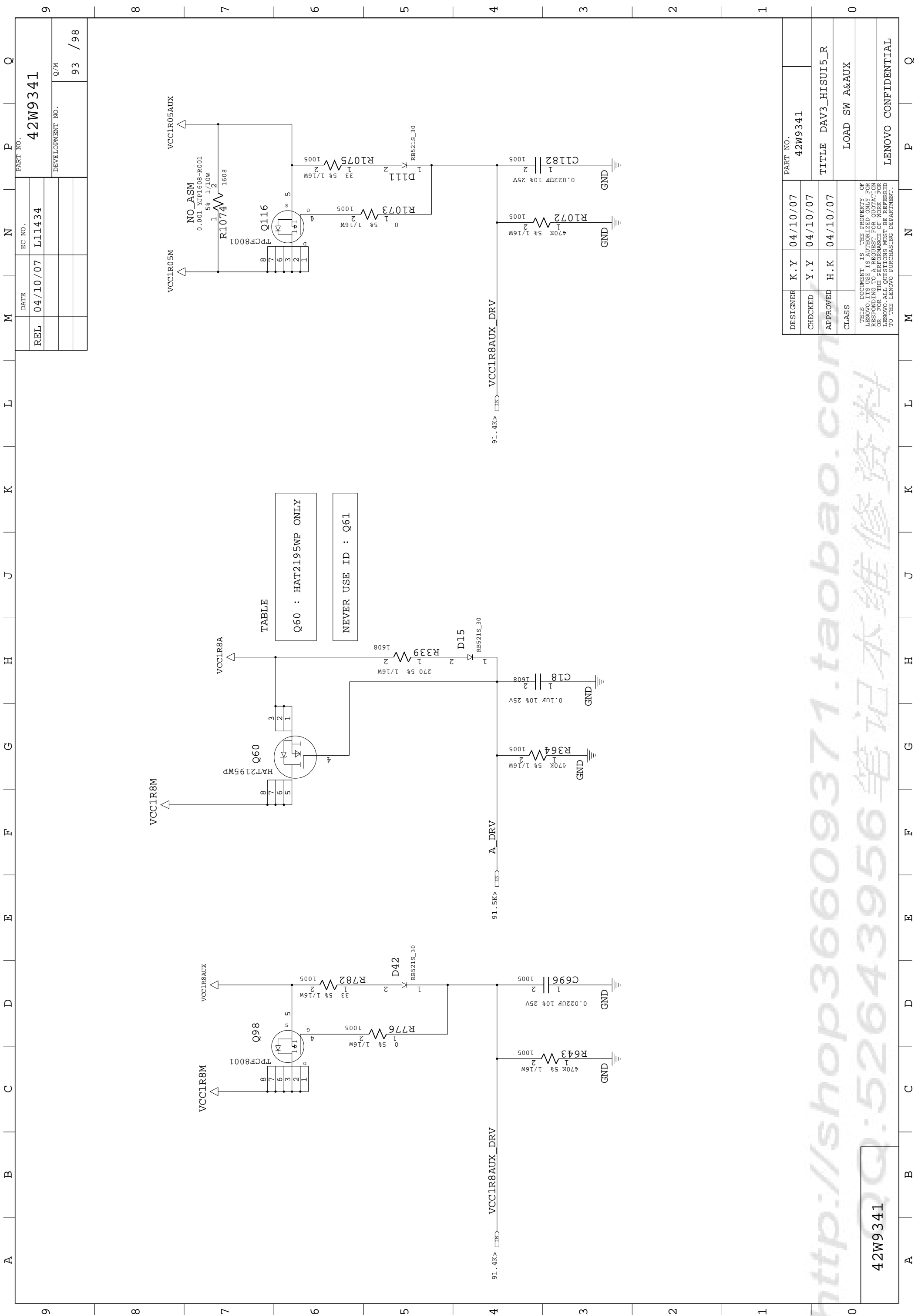

REL	DATE	EC NO.	PART NO.
	04/10/07	L11434	42W9341
			DEVELOPMENT NO.
			93 / 98

DESIGNER	K.Y	04/10/07	PART NO.	42W9341
CHECKED	Y.Y	04/10/07	TITLE	DAV3_HISUI5_R
APPROVED	H.K	04/10/07	LOAD SW	A&AUX
CLASS			THIS DOCUMENT IS THE PROPERTY OF LENOVO. IT IS LOANED TO YOU FOR USE ONLY. IT IS NOT TO BE REPRODUCED OR TRANSMITTED IN ANY FORM OR BY ANY MEANS, ELECTRONIC OR MECHANICAL, INCLUDING PHOTOCOPYING, RECORDING, OR BY ANY INFORMATION STORAGE AND RETRIEVAL SYSTEM, WITHOUT PERMISSION IN WRITING FROM LENOVO. ALL QUESTIONS MUST BE REFERRED TO THE LENOVO PURCHASING DEPARTMENT.	

http://shop36609371.taobao.com 笔记本维修资料

42W9341

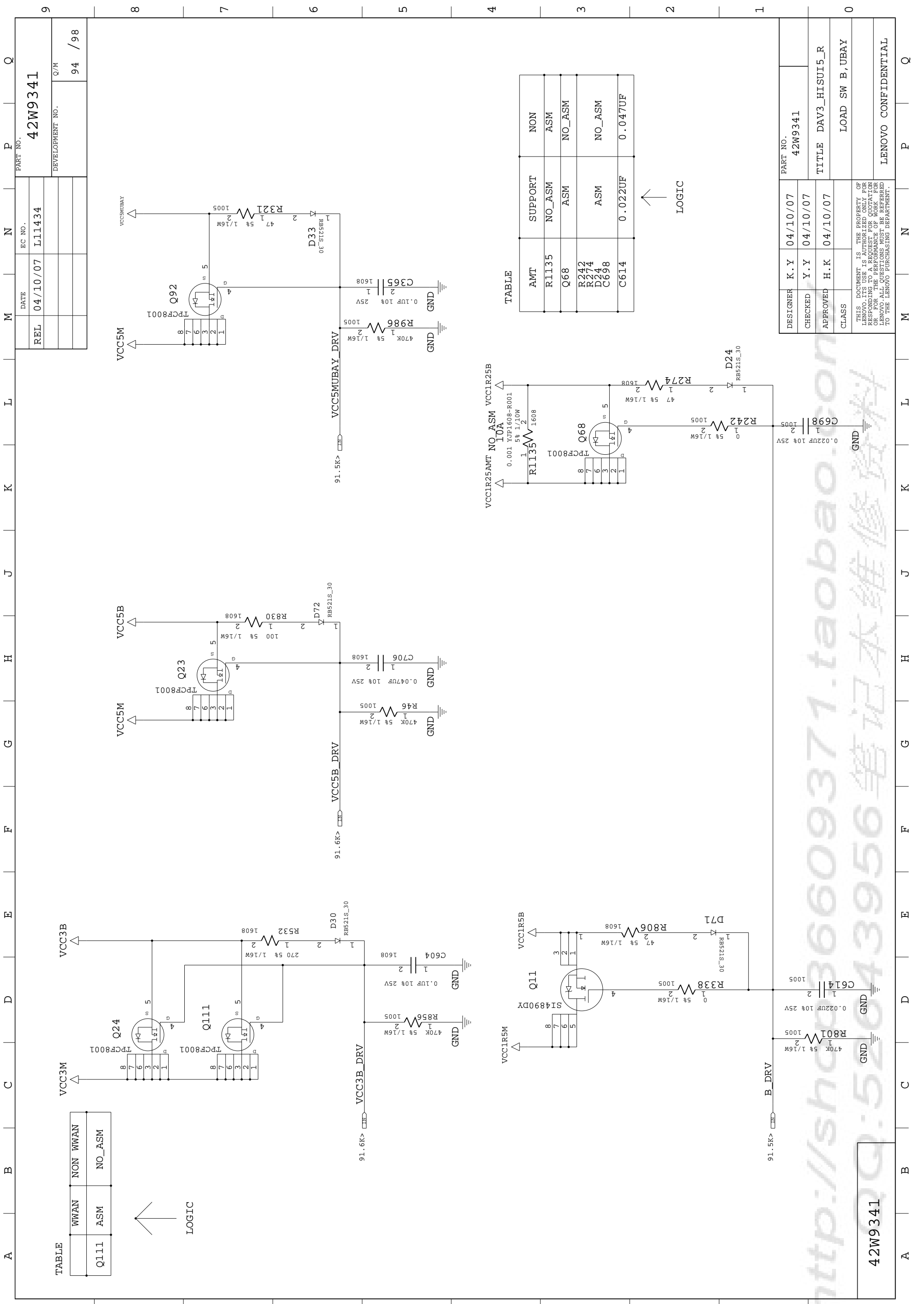

TABLE

Q111	NON WWAN
	NO_ASM

TABLE

AMT	SUPPORT	NON
R1135	NO_ASM	ASM
Q68	ASM	NO_ASM
R242	ASM	NO_ASM
R274	ASM	NO_ASM
D24	ASM	NO_ASM
C698	0.022UF	0.047UF

DESIGNER	K.Y	04/10/07	PART NO.	42W9341
CHECKED	Y.Y	04/10/07	TITLE	DAV3_HISUI5_R
APPROVED	H.K	04/10/07	CLASS	LOAD SW B,UBAY
THIS DOCUMENT IS THE PROPERTY OF LENOVO. IT IS LOANED TO YOU FOR YOUR USE ONLY. IT IS NOT TO BE REPRODUCED OR TRANSMITTED IN ANY FORM OR BY ANY MEANS, FOR OR FOR THE PERFORMANCE OF WORK FOR LENOVO. ALL QUESTIONS MUST BE REFERRED TO THE LENOVO PURCHASING DEPARTMENT.				

42W9341

http://shop36609371.taobao.com 笔记本维修资料

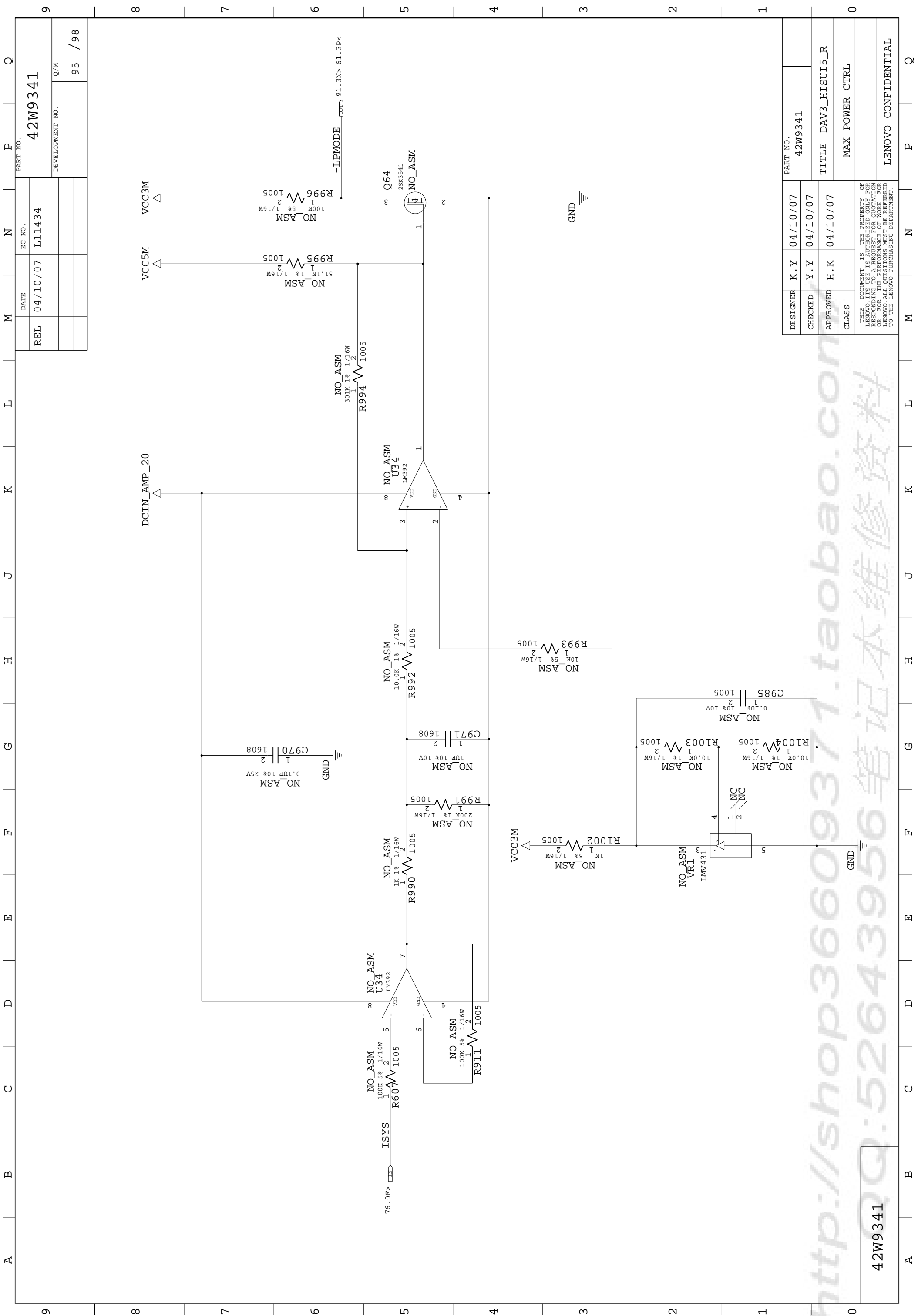

REL	DATE	EC NO.	PART NO.
	04/10/07	L11434	42W9341
			DEVELOPMENT NO.
			Q/M
			95 / 98

DESIGNER	K.Y	04/10/07	PART NO.	42W9341
CHECKED	Y.Y	04/10/07	TITLE	DAV3_HISUI5_R
APPROVED	H.K	04/10/07	CLASS	MAX POWER CTRL
THIS DOCUMENT IS THE PROPERTY OF LENOVO. IT IS LOANED TO YOU FOR USE ONLY. NO REPRODUCTION OR DISTRIBUTION IS PERMITTED WITHOUT THE WRITTEN PERMISSION OF LENOVO. FOR THE PERFORMANCE OF WORK FOR LENOVO. ALL QUESTIONS MUST BE REFERRED TO THE LENOVO PURCHASING DEPARTMENT.				

42W9341

http://shop36609371.taobao.com 笔记本维修资料

REL	04/10/07	L111434	42W9341
DEVELOPMENT NO.			96 / 98

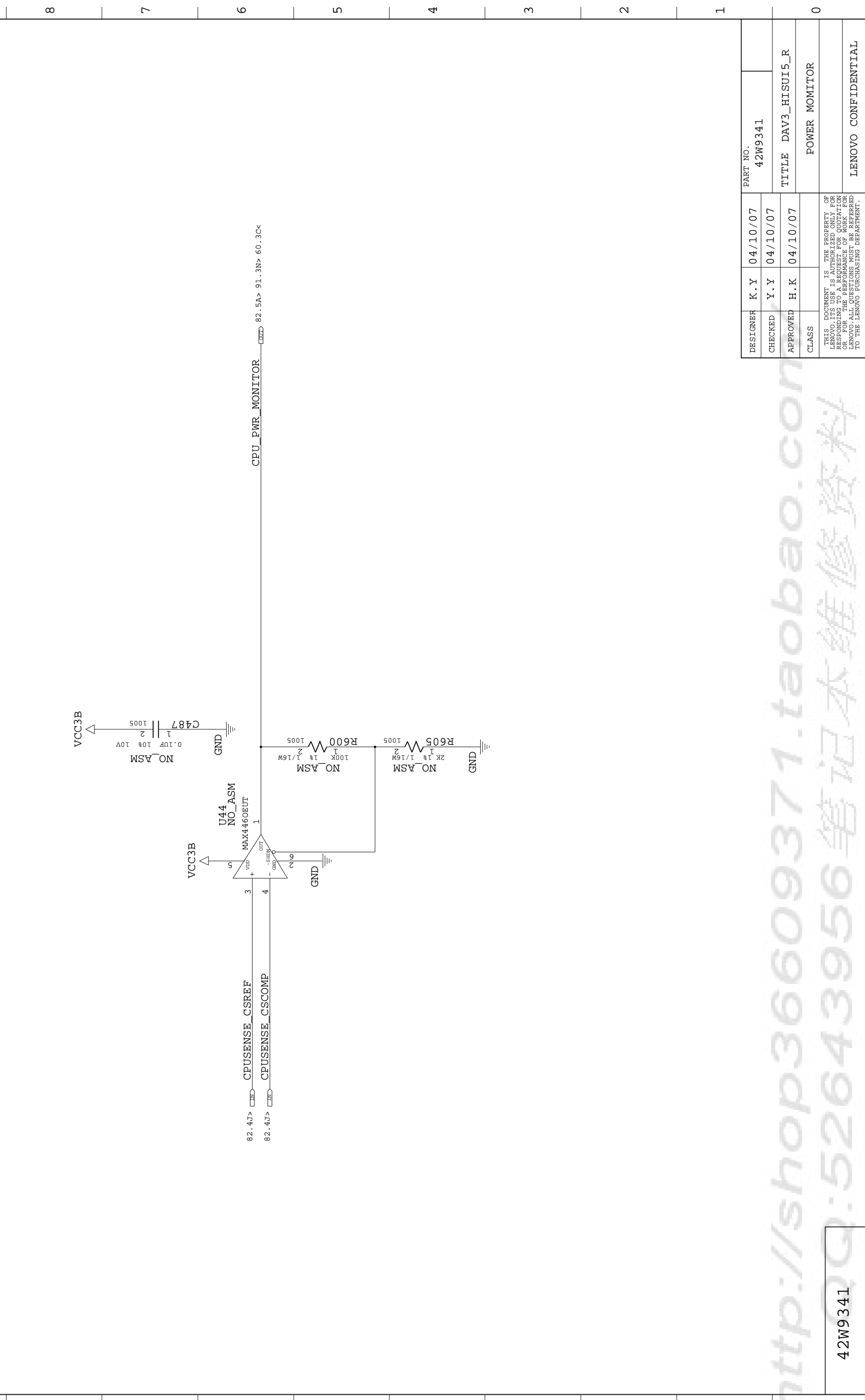

DESIGNER	K.Y	04/10/07	PART NO.	42W9341
CHECKED	Y.Y	04/10/07	TITLE	DAV3_HISUI5_R
APPROVED	H.K	04/10/07	POWER MONITOR	
CLASS				

THIS DOCUMENT IS THE PROPERTY OF LENOVO. IT IS LOANED TO YOU FOR USE ONLY IN CONNECTION WITH THE WORK YOU ARE PERFORMING FOR LENOVO. ALL QUESTIONS MUST BE REFERRED TO THE LENOVO PURCHASING DEPARTMENT.

http://shop36609371.taobao.com  
 52643956 笔记本维修资料



9	A	B	C	D	E	F	G	H	J	K	L	M	N	P	Q
DATE 04/10/07 EC NO. L11434 PART NO. 42W9341 REL DEVELOPMENT NO. Q/M 97 / 98															

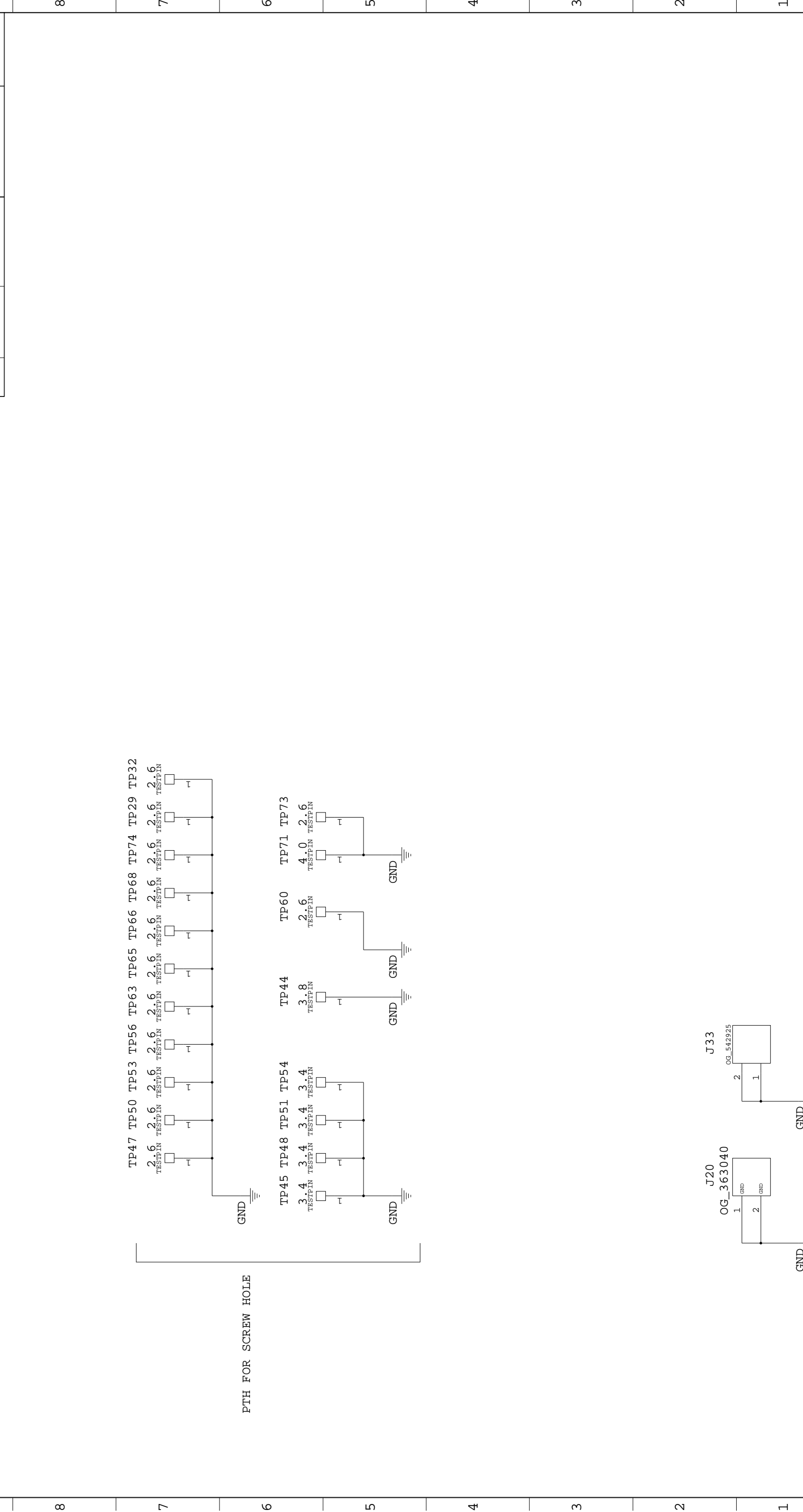

DESIGNER	K.Y	04/10/07	PART NO.	42W9341
CHECKED	Y.Y	04/10/07	TITLE	DAV3_HISUI5_R
APPROVED	H.K	04/10/07	PTH FOR SCREW HOLES	
CLASS				
THIS DOCUMENT IS THE PROPERTY OF LENOVO. IT IS LOANED TO YOU FOR USE ONLY. IT IS NOT TO BE REPRODUCED OR TRANSMITTED IN ANY FORM OR BY ANY MEANS, ELECTRONIC OR MECHANICAL, INCLUDING PHOTOCOPYING, RECORDING, OR BY ANY INFORMATION STORAGE AND RETRIEVAL SYSTEM, WITHOUT PERMISSION IN WRITING FROM LENOVO. ALL QUESTIONS MUST BE REFERRED TO THE LENOVO PURCHASING DEPARTMENT.				

http://shop36609371.taobao.com 笔记本电脑维修资料

42W9341

9	A	B	C	D	E	F	G	H	J	K	L	M	N	P	Q
---	---	---	---	---	---	---	---	---	---	---	---	---	---	---	---

REL	DATE	EC NO.	PART NO.
	04/10/07	L11434	42W9341
			DEVELOPMENT NO.
			Q/M
			98 / 98

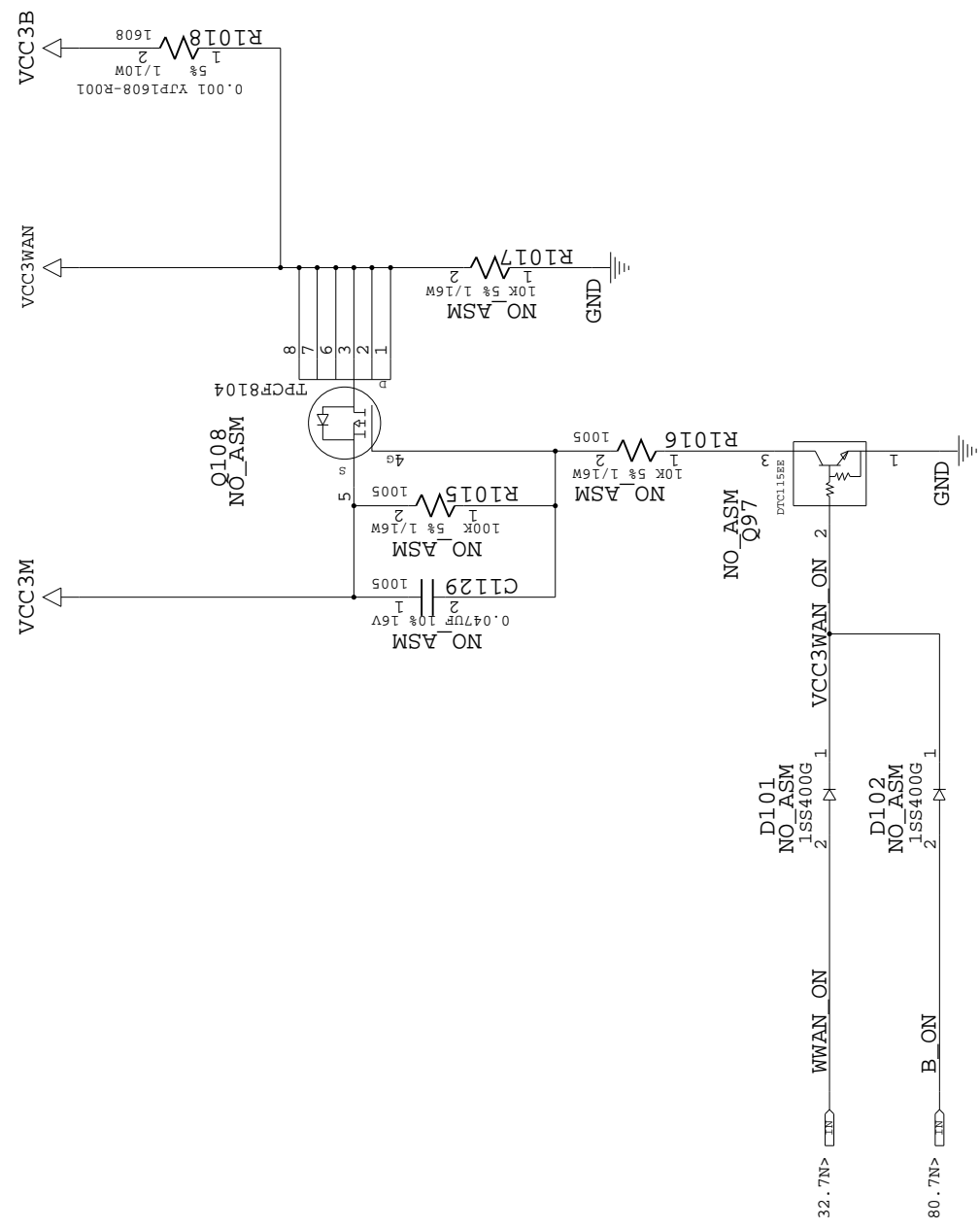

DESIGNER	K.Y	04/10/07	PART NO.	42W9341
CHECKED	Y.Y	04/10/07	TITLE	DAV3_HISUI5_R
APPROVED	H.K	04/10/07	CLASS	LOAD SW VCC3KDDI
THIS DOCUMENT IS THE PROPERTY OF LENOVO. IT IS LOANED TO YOU FOR YOUR USE ONLY. IT IS NOT TO BE REPRODUCED OR TRANSMITTED IN ANY FORM OR BY ANY MEANS, ELECTRONIC OR MECHANICAL, INCLUDING PHOTOCOPYING, RECORDING, OR BY ANY INFORMATION STORAGE AND RETRIEVAL SYSTEM. WITHOUT PERMISSION IN WRITING FROM LENOVO, ALL QUESTIONS MUST BE REFERRED TO THE LENOVO PURCHASING DEPARTMENT.				

http://shop36609371.taobao.com 笔记本维修资料

42W9341