

SHEET TITLE

01	COVER SHEET
02	BLOCK DIAGRAM
03	BOM & PCB MODIFY HISTORY
04	P4_LGA775_A
05	P4_LGA775_B
06	P4_LGA775_C
07	P4_LGA775_D,E,F,G
08	GMCH-LAKEPORT_HOST
09	GMCH-LAKEPORT_DDRII
10	GMCH-LAKEPORT_PCI E, DMI
11	GMCH-LAKEPORT_INT VGA
12	GMCH-LAKEPORT_GND
13	GMCH-LAKEPORT_PWR
14	DDRII CHANNEL A 1
15	DDRII CHANNEL B 2
16	DDRII TERMINATION
17	PCI EXPRESS*16 SLOT
18	ICH7 PCI, USB, DMI, LAN
19	ICH7 IDE, GPIO, SATA, CTRL
20	ICH7 VCC, GND
21	GB/CK410M CLOCK.
22	PCI SLOT 1,2,3
23	IDE/FLOPPY
24	ITE 8712 GBIX
25	COM_LPT
26	BIOS,CI,HWM,KB/MS
27	AC97 ALC655

SHEET TITLE

28	REAR AUDIO JACK
29	DISCRETE POWER
30	VCORE PWM_ISL6556
31	ATX, OTHERS POWER
32	RTL8110S/RTL8100C
33	FRONT PANEL

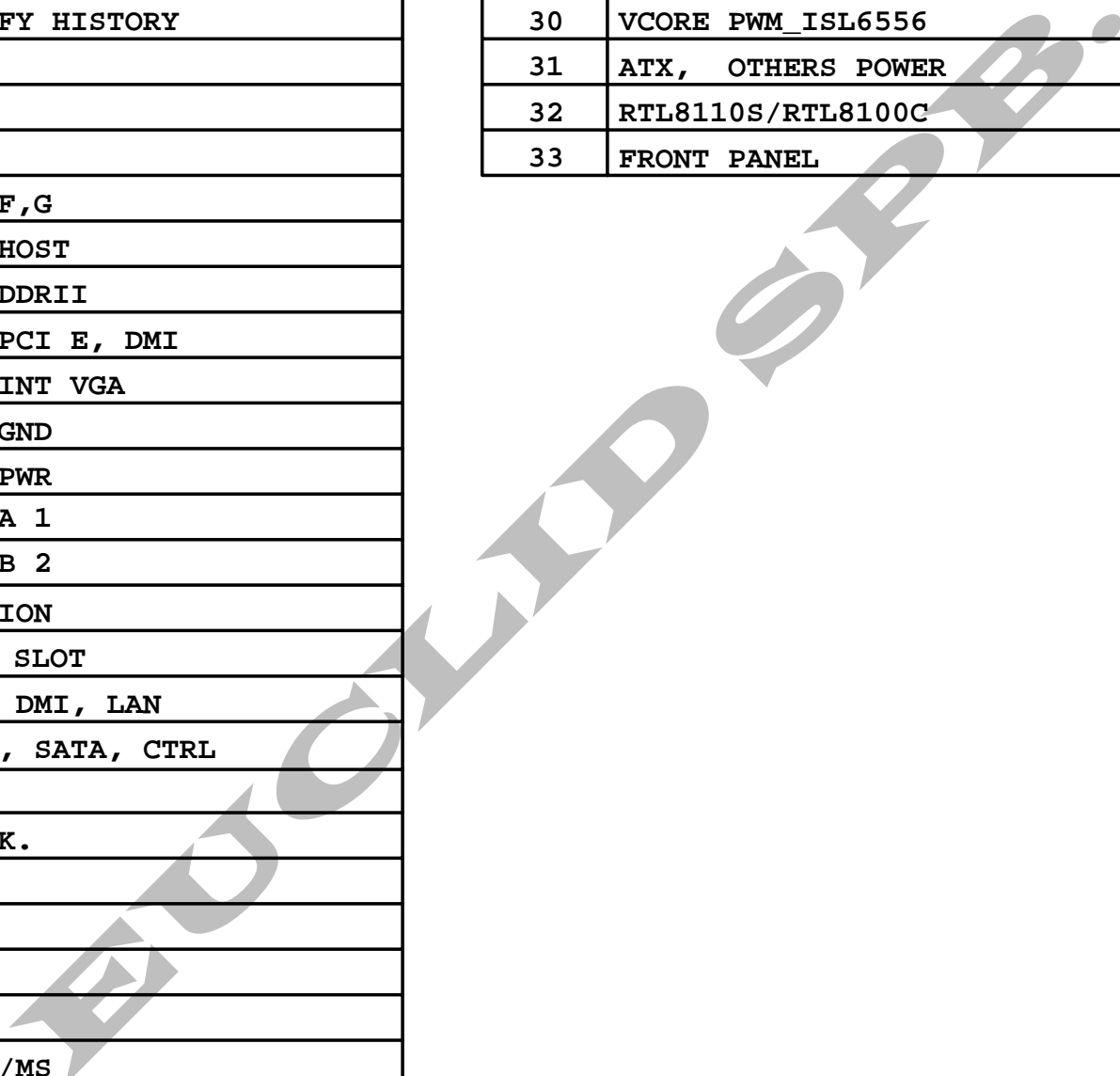

# BLOCK DIAGRAM

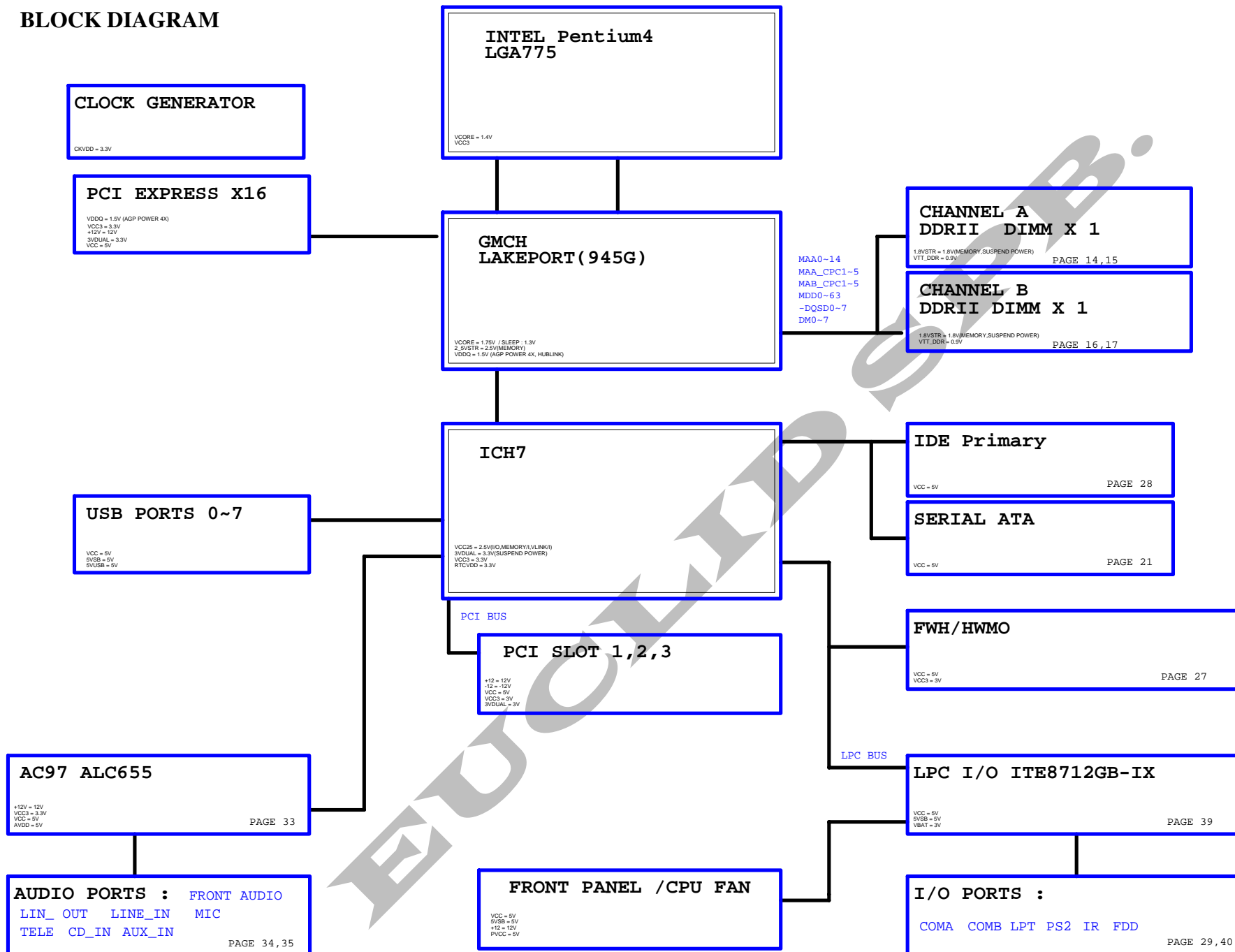



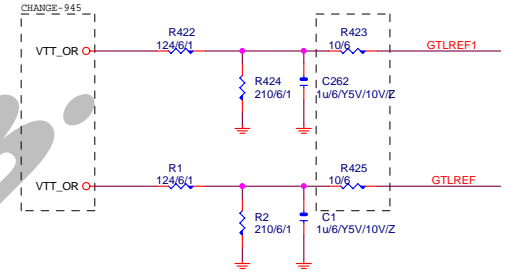
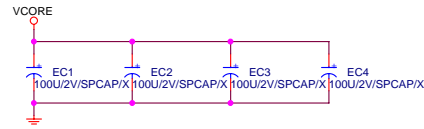
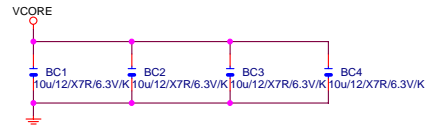
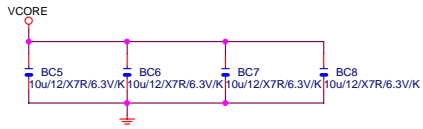

LGA775-D [DIP TYPE]

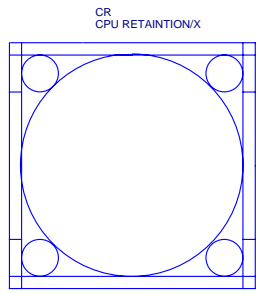
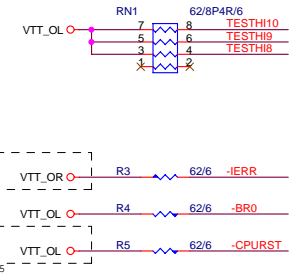
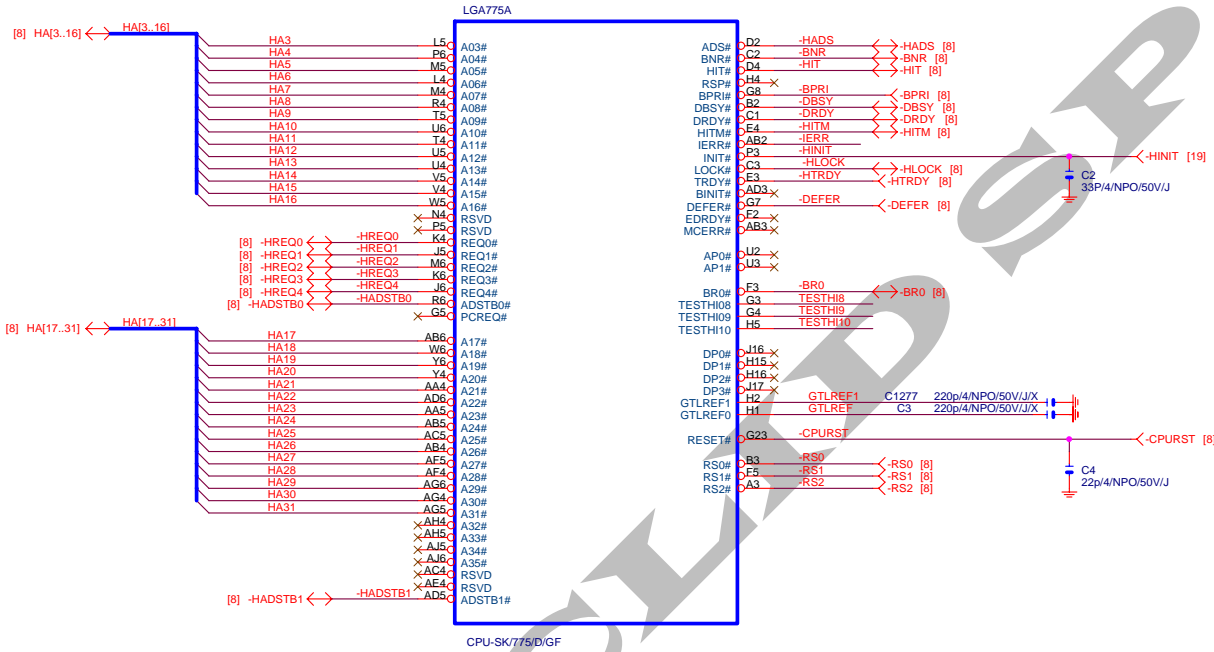

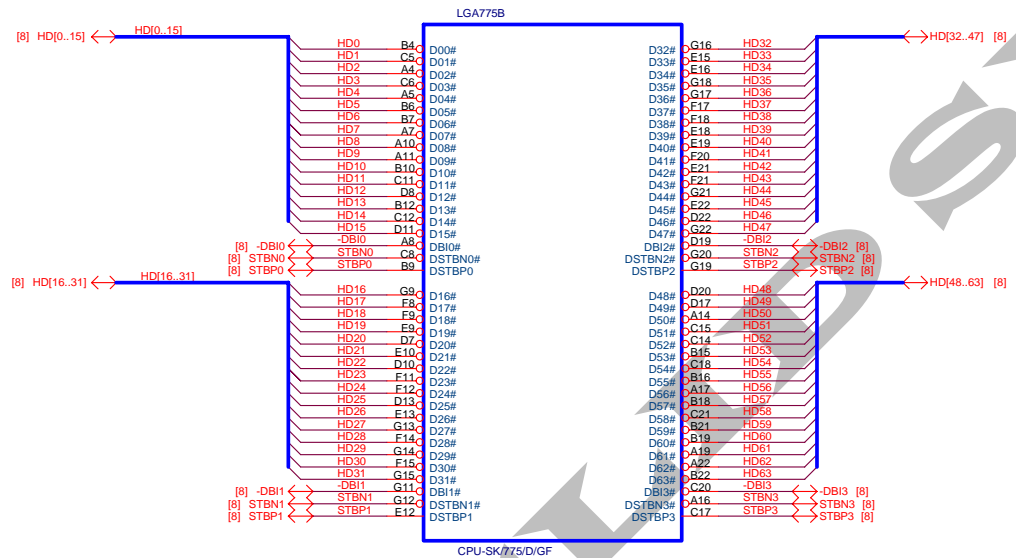

**Note:**  
VCCA & VCOREPLL  
define doesn't same as  
old P4 design kit

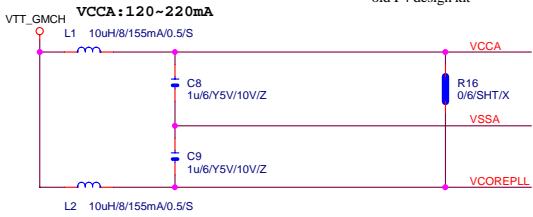

Trace width doesn't  
less than 12 Mil

As close as possible to  
CPU socket

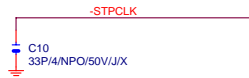

[24,26] CPU\_TEMP  
[24] THERMDC

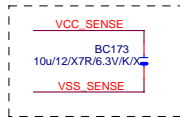
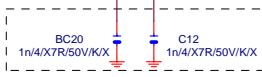

945 Design Guide rev1.5 spec.  
VCCA=120~220mA  
公板為125mA

10LI2-12100A-03=INDUCTOR 10uH 300mA TAI-TECH  
10LI2-12100A-02=INDUCTOR 10uH 155mA TAIYO  
10LI2-12100A-01=INDUCTOR 10uH 120mA TDK

CPU

FSA	FSB	NA	Clock
FSBSEL0	FSBSEL1	FSBSEL3	Clock
1	0	1	100MHz
1	0	0	133MHz
1	1	0	166MHz
0	1	0	200MHz
0	0	0	266MHz

X

RATIO

2.66/3.33

2.00/2.5

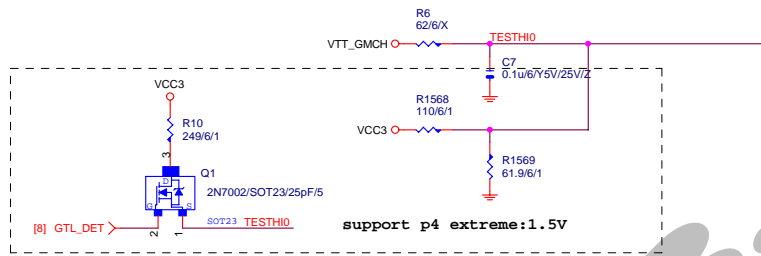

support p4 extreme:1.5v

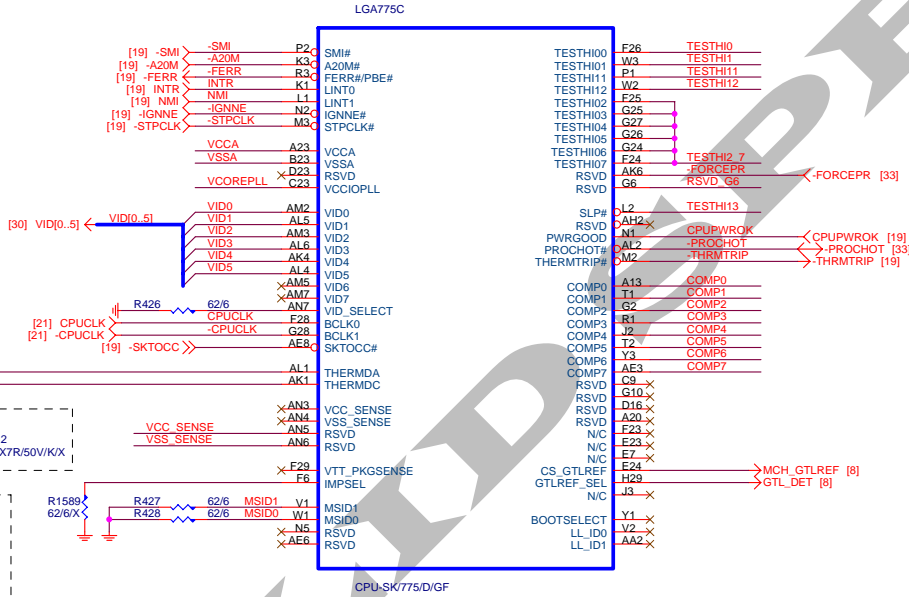

Place outside of CPU socket

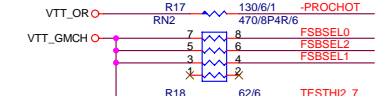
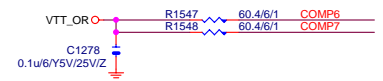
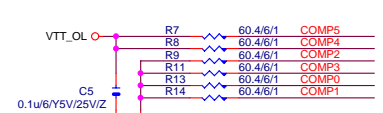

Locate at ICH7 Side

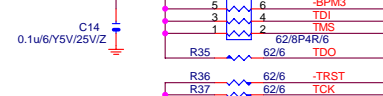
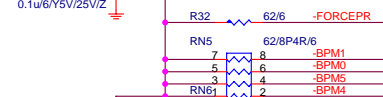
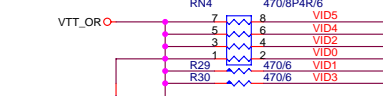
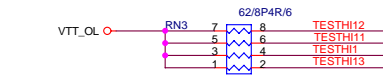
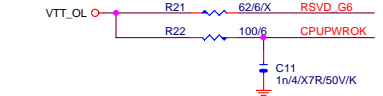

Gigabyte Technology

Title			P4_LGA775-B		
Size	Document Number	81945GME		Rev	1.0
Custom	Date:	Monday, October 31, 2005	Sheet	6	of 33

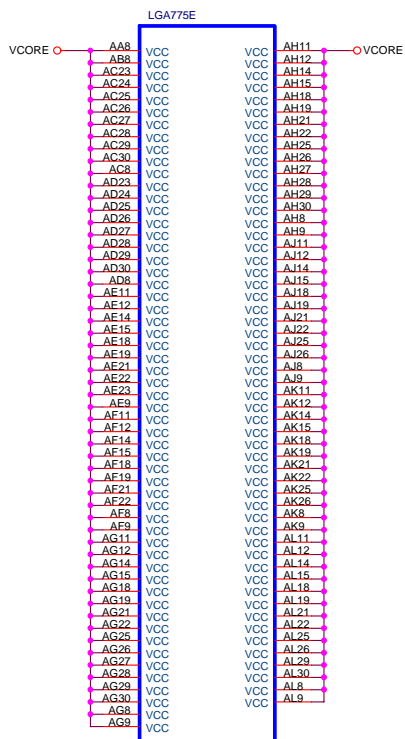

CPU-SK/775/D/GF

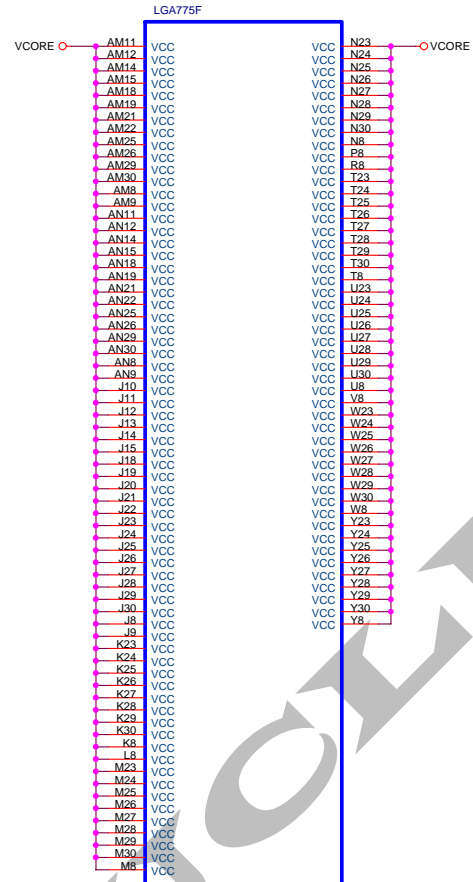

CPU-SK/775/D/GF

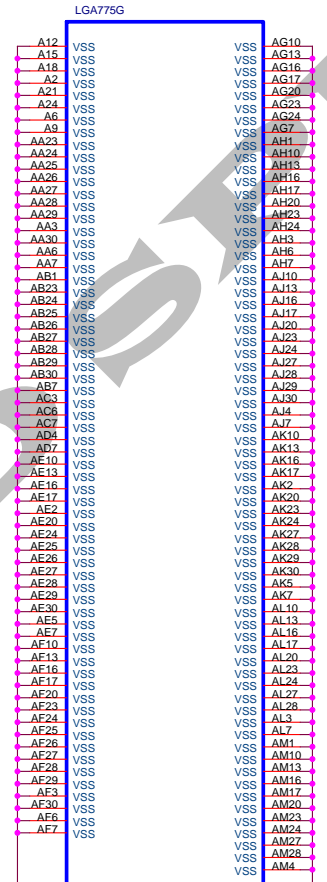

CPU-SK/775/D/GF

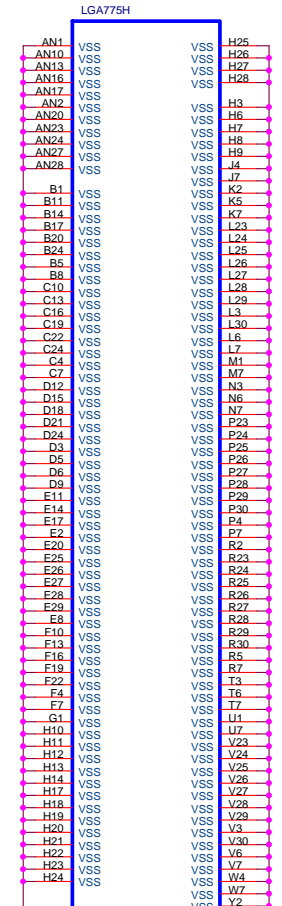

CPU-SK/775/D/GF

**Gigabyte Technology**

Title			P4_LGA775-D		
Size	Document Number	81945GME			Rev
Custom					1.0
Date:	Monday, October 31, 2005	Sheet	7	of	33

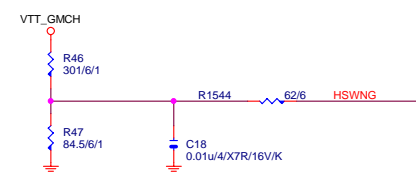
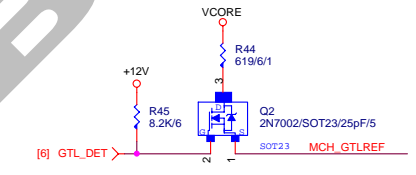
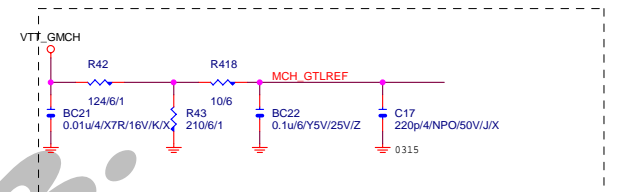
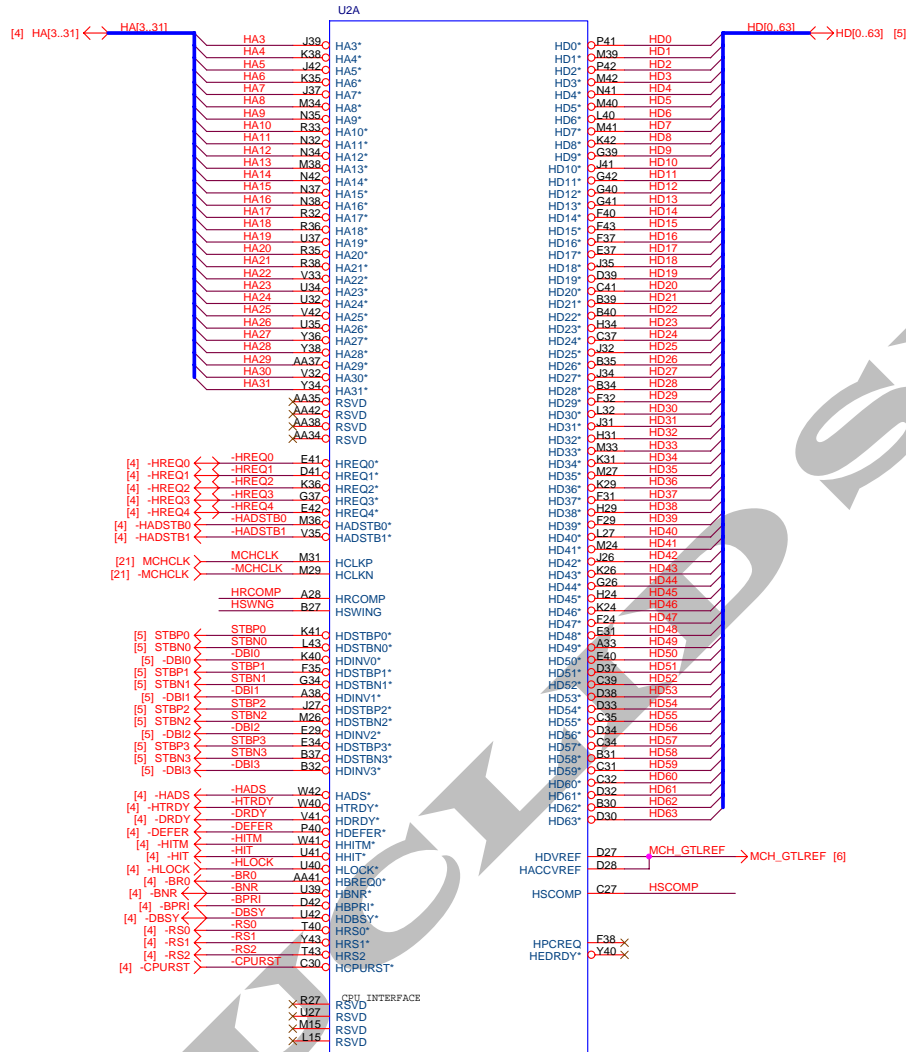

<b>Gigabyte Technology</b>			
Title <b>GMCH-HOST</b>			
Size Custom	Document Number <b>81945GME</b>	Rev <b>1.0</b>	
Date: Monday, October 31, 2005	Sheet 8	of 33	



U2F

MAAA0	BA32	SAMA0
MAAA1	BB30	SAMA1
MAAA2	BA30	SAMA2
MAAA3	AY30	SAMA3
MAAA4	AY30	SAMA4
MAAA5	BA27	SAMA5
MAAA6	BC28	SAMA6
MAAA7	AY27	SAMA7
MAAA8	AY28	SAMA8
MAAA9	BB27	SAMA9
MAAA10	AY33	SAMA10
MAAA11	AW27	SAMA11
MAAA12	BB26	SAMA12
MAAA13	BC38	SAMA13
[14,16] -SWEA	BB35C	SAWE-
[14,16] -SCASA	BA37C	SACAS+
[14,16] -SRASA	BA34C	SARAS+
[14,16] SBAA0	BC33	SABA_0
[14,16] SBAA1	AY34	SABA_1
[14,16] SBAA2	BA26	SABA_2
[14,16] -CSA0	BB37C	SACS_0*
[14,16] -CSA1	BA39C	SACS_1*
[16] -CSA2	BA35C	SACS_2*
[16] -CSA3	AY38C	SACS_3*
[14,16] CKEA0	BB25	SACKE0
[14,16] CKEA1	AY25	SACKE1
[16] CKEA2	BC24	SACKE2
[16] CKEA3	BA25	SACKE3
MODT_A0	AY37	SAODT0
MODT_A1	AY39	SAODT1
MODT_A2	AY37	SAODT2
MODT_A3	BB40	SAODT3
[14] DCLKA0	BB32	SACK0
[14] DCLKA0	AY32C	SACK0*
[14] DCLKA1	AY5	SACK1
[14] -DCLKA1	BB5C	SACK1*
[14] DCLKA2	AK42	SACK2
[14] -DCLKA2	AK41C	SACK2*
[14] -DCLKA2	AK41C	SACK3
BB31C		SACK3*
AY6		SACK4
BA5C		SACK4*
AH40		SACK5
AH43C		SACK5*
AK18	RSV_TP(3)	
AM4	SMVREF0	
AK17C	RSV_TP(1)	
AK17C	RSV_TP(0)	
AG42	DQSA6	
AG41	-DQSA6	
AG40	DMA6	
AL41	MDA48	
AL42	MDA49	
AF39	MDA50	
AE40	MDA51	
AM40	MDA52	
AM42	MDA53	
AF41	MDA54	
AF42	MDA55	
AC42	DQSA7	
AC41	-DQSA7	
AC40	DMA7	
AD40	MDA56	
AD43	MDA57	
AA39	MDA58	
AA40	MDA59	
AE42	MDA60	
AE41	MDA61	
AB41	MDA62	
AB42	MDA63	

945G/A2[10HB1-033000-22R]

U2G

MAAB0	BB22	SBMA0
MAAB1	BB21	SBMA1
MAAB2	BA21	SBMA2
MAAB3	AY21	SBMA3
MAAB4	BC20	SBMA4
MAAB5	AY19	SBMA5
MAAB6	AY20	SBMA6
MAAB7	BA18	SBMA7
MAAB8	BB18	SBMA8
MAAB9	BB18	SBMA9
MAAB10	BA22	SBMA10
MAAB11	BB17	SBMA11
MAAB12	BA17	SBMA12
MAAB13	AW42	SBMA13
[15,16] -SWEB	BB23C	SBWE-
[15,16] -SCASB	AY24C	SBCAS+
[15,16] -SRASB	BA23C	SBRAS+
[15,16] SBAB0	AW23	SBBA0
[15,16] SBAB1	AY17	SBBA1
[15,16] SBAB2	AY17	SBBA2
[15,16] -CSB0	BA40C	SBCS0*
[15,16] -CSB1	AW41C	SBCS1*
[16] -CSB2	BA44C	SBCS2*
[16] -CSB3	AW40C	SBCS3*
[15,16] CKEB0	BA14	SBCKE0
[15,16] CKEB1	AY16	SBCKE1
[16] CKEB3	BA13	SBCKE2
[16] CKEB3	BB13	SBCKE3
MODT_B0	AY42	SBODT0
MODT_B1	AV40	SBODT1
MODT_B2	AV43	SBODT2
MODT_B3	AU40	SBODT3
[15] DCLKB0	AM29	SBCK0
[15] -DCLKB0	AM27C	SBCK0*
[15] DCLKB1	AL38	SBCK1
[15] -DCLKB1	AW8C	SBCK1*
[15] DCLKB2	AL38	SBCK2
[15] -DCLKB2	AL36C	SBCK2*
AP26		SBCK3
AL26C		SBCK3*
AL10		SBCK4
AL10		SBCK4*
AL38		SBCK5
AL36C		SBCK5*
AL39	RSV	
AM2	SMVREF1	
AK23C	RSV_TP(2)	
AM3	SM_OCDCOMP_1	
AL8	SM_OCDCOMP_0	
AL6	SM_RCOMP1	
AL5	SM_RCOMP0	

945G/A2[10HB1-033000-22R]

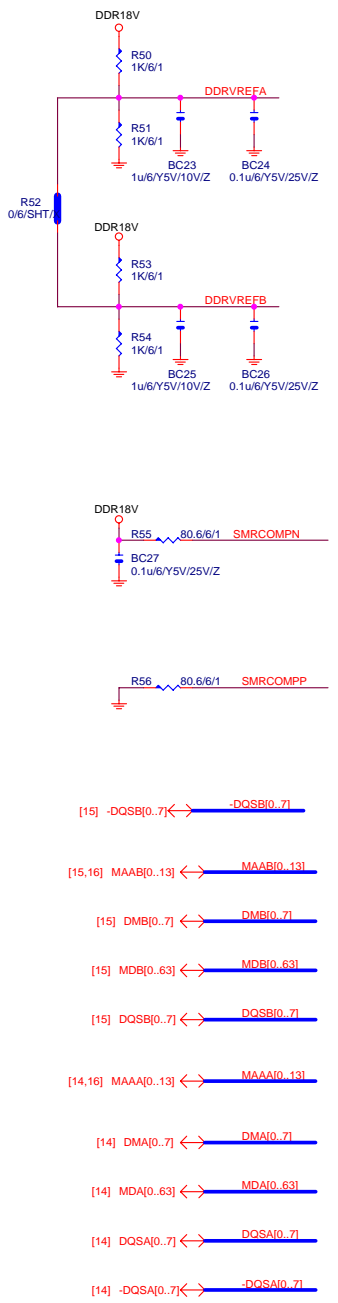

NB\_HEATSIN

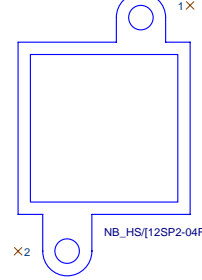

Gigabyte Technology

Title			GMCH-DDRII
Size			81945GME
Document Number	81945GME		Rev 1.0
Date:	Monday, October 31, 2005	Sheet 9	of 33

U2B

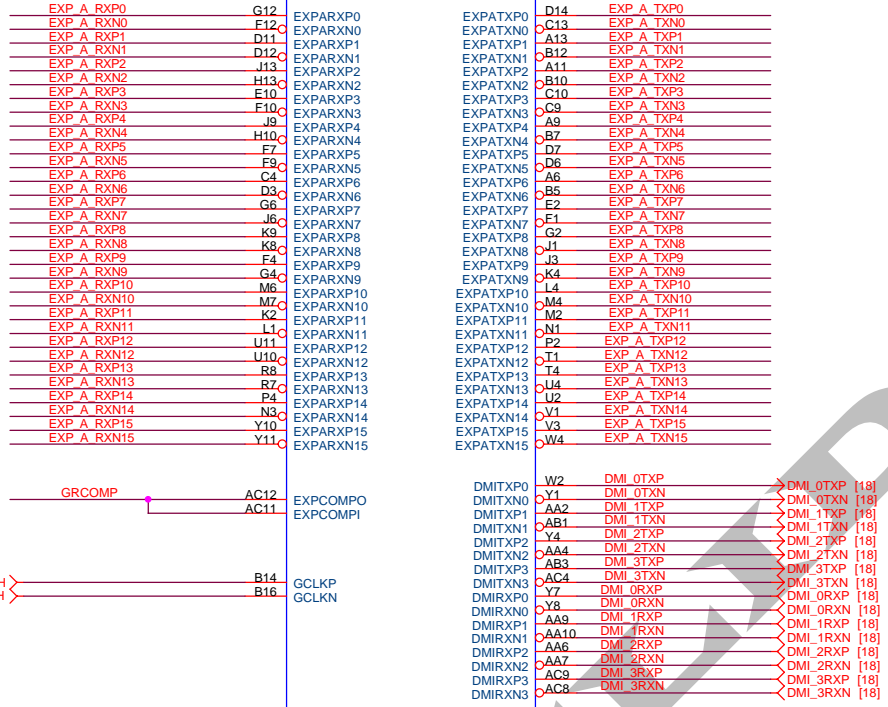

945G/A2[10HB1-033000-22R]

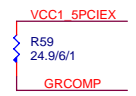
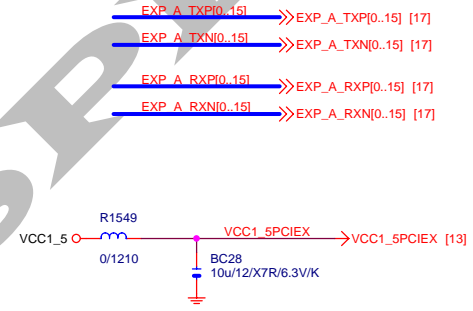

[21] SRCCLK\_MCH

[21] -SRCCLK\_MCH

**Gigabyte Technology**

Title		
GMCH-PCI E & DMI		
Size Custom	Document Number	Rev
	<b>81945GME</b>	<b>1.0</b>
Date:	Monday, October 31, 2005	Sheet 10 of 33

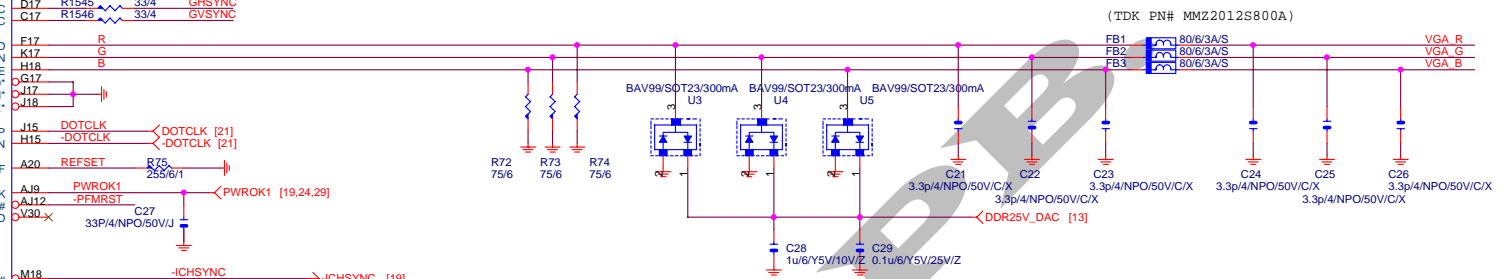
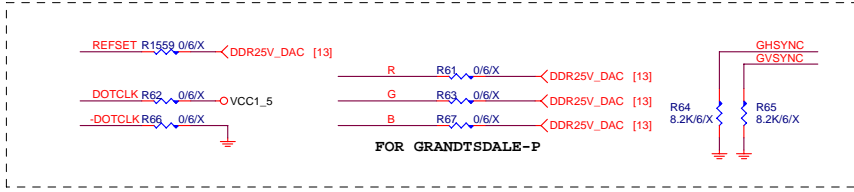
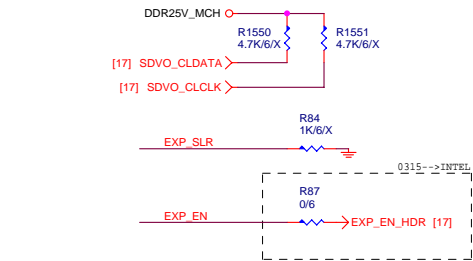
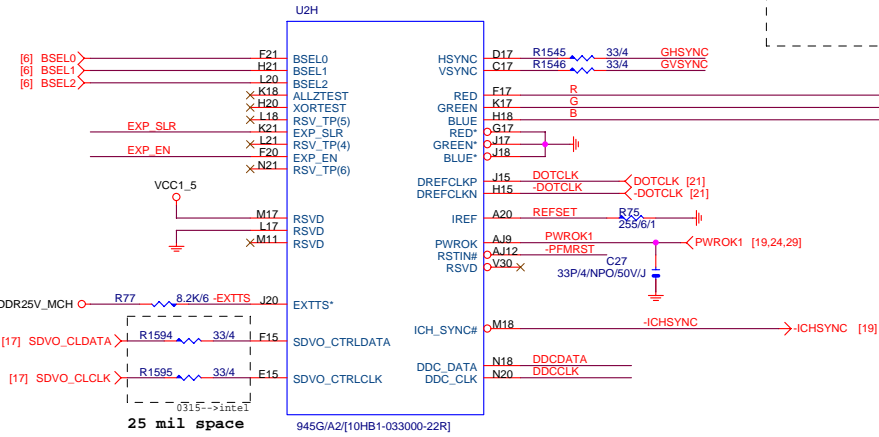

**DDR25V\_DAC: 75mA**

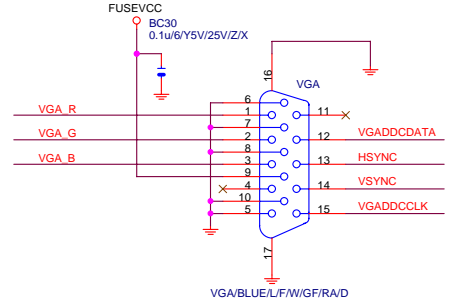
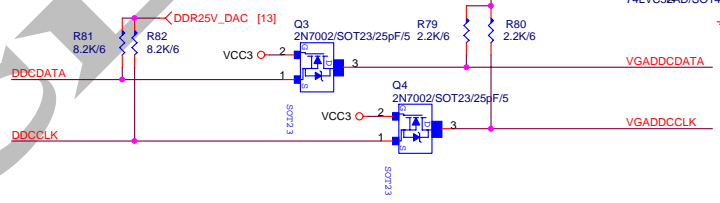

U2C

A4	VSS	N2
A16	VSS	N6
A22	VSS	N8
A26	VSS	N13
A31	VSS	N15
A35	VSS	N24
B4	VSS	N26
B6	VSS	N27
B9	VSS	N29
B11	VSS	N31
B13	VSS	N33
B21	VSS	N36
B22	VSS	N39
B28	VSS	N43
B33	VSS	P3
B38	VSS	P14
C3	VSS	P15
C5	VSS	P24
C7	VSS	P26
C12	VSS	P27
C14	VSS	P29
C22	VSS	P30
C40	VSS	R6
D2	VSS	R9
D5	VSS	R12
D10	VSS	R14
D16	VSS	R30
D20	VSS	R31
D21	VSS	R34
E4	VSS	R37
E7	VSS	R39
E9	VSS	T2
E12	VSS	T42
E13	VSS	U3
E17	VSS	U5
E18	VSS	U8
E20	VSS	U12
E21	VSS	U14
E32	VSS	U31
F2	VSS	U33
F6	VSS	U36
F13	VSS	U38
F18	VSS	U39
F26	VSS	V11
F34	VSS	V12
F42	VSS	V14
G3	VSS	V14
G5	VSS	V36
G7	VSS	V37
G9	VSS	V38
G10	VSS	V39
G13	VSS	V43
G15	VSS	W3
G18	VSS	Y2
G20	VSS	Y5
G21	VSS	Y6
G24	VSS	Y9
G27	VSS	Y14
G29	VSS	Y31
G31	VSS	Y35
G32	VSS	Y37
G35	VSS	Y39
G38	VSS	Y42
H12	VSS	AA3
H26	VSS	AA8
H27	VSS	AA11
H32	VSS	AA12
I2	VSS	AA14
J5	VSS	AA21
J7	VSS	AA23
J10	VSS	AA31
J12	VSS	AP5
J21	VSS	AP7
J24	VSS	AP10
J38	VSS	AP12
J43	VSS	AP21
K3	VSS	AP34
K5	VSS	AP38
K6	VSS	AR1
K7	VSS	AR6
K10	VSS	AR15
K12	VSS	AR20
K13	VSS	AR23
K15	VSS	AR31
K20	VSS	AR37
K27	VSS	AR39
K32	VSS	AR43
K34	VSS	AT12
K37	VSS	AT17
K39	VSS	AT18
L2	VSS	AT21
L12	VSS	AT23
L13	VSS	AT26
L24	VSS	AT27
L26	VSS	AT31
L29	VSS	AU6
L31	VSS	AU9
L42	VSS	AU12
M3	VSS	AL13
M5	VSS	AL15
M8	VSS	AL17
M10	VSS	AU20
M13	VSS	AD18
M20	VSS	AD20
M21	VSS	AD22
M35	VSS	AD24
M37	VSS	AD27

945G/A2[10HB1-033000-22R]

U2E

AD7	VSS	AD7
AD11	VSS	N8
AD13	VSS	N13
AD33	VSS	N15
N24	VSS	N24
AD37	VSS	N26
AD42	VSS	N27
N29	VSS	N29
AF1	VSS	N31
AF2	VSS	N33
AF3	VSS	N36
AF5	VSS	N39
AF36	VSS	N43
AF38	VSS	P3
P14	VSS	P14
P15	VSS	P15
AG30	VSS	P24
AG31	VSS	P26
AG33	VSS	P27
AG36	VSS	P29
AG37	VSS	P30
AG38	VSS	R6
AG39	VSS	R9
AH42	VSS	R12
AJ7	VSS	R14
AJ10	VSS	R30
AJ30	VSS	R31
AJ31	VSS	R34
AJ33	VSS	R37
AJ35	VSS	R39
AJ37	VSS	T2
AK24	VSS	T42
AK26	VSS	U3
AK29	VSS	U5
AK30	VSS	U8
AL1	VSS	U12
AL3	VSS	U14
AL7	VSS	U31
AL10	VSS	U33
AL12	VSS	U36
AL13	VSS	U38
AL15	VSS	U39
AL18	VSS	V11
AL21	VSS	V12
AL23	VSS	V14
AL24	VSS	V14
AL27	VSS	V36
AL32	VSS	V37
AL33	VSS	V38
AL37	VSS	V39
AM43	VSS	V43
AM5	VSS	W3
AM7	VSS	Y2
AM12	VSS	Y5
AM33	VSS	Y6
AM36	VSS	Y9
AM37	VSS	Y14
AM39	VSS	Y31
AN2	VSS	Y35
AN4	VSS	Y37
AN13	VSS	Y39
AN15	VSS	Y42
AN17	VSS	AA3
AN18	VSS	AA8
AN20	VSS	AA11
AN21	VSS	AA12
AN23	VSS	AA14
AN24	VSS	AA21
AN26	VSS	AA23
AN27	VSS	AA31
AN31	VSS	AP5
AN42	VSS	AP7
AP5	VSS	AP10
AP7	VSS	AP12
AP10	VSS	AP21
AP12	VSS	AP34
AP21	VSS	AP38
AP34	VSS	AR1
AP38	VSS	AR6
AR1	VSS	AR15
AR6	VSS	AR20
AR15	VSS	AR23
AR20	VSS	AR31
AR23	VSS	AR37
AR31	VSS	AR39
AR37	VSS	AR43
AR39	VSS	AT12
AR43	VSS	AT17
AT12	VSS	AT18
AT17	VSS	AT21
AT18	VSS	AT23
AT21	VSS	AT26
AT23	VSS	AT27
AT26	VSS	AT31
AT27	VSS	AU6
AU6	VSS	AU9
AU9	VSS	AU12
AU12	VSS	AL13
AL13	VSS	AL15
AL15	VSS	AL17
AL17	VSS	AU20
AU20	VSS	AD18
AD18	VSS	AD20
AD20	VSS	AD22
AD22	VSS	AD24
AD24	VSS	AD27
AD27	VSS	AD29
AD29	VSS	AE19
AE19	VSS	AE21
AE21	VSS	AE23
AE23	VSS	AE25
AE25	VSS	AF18
AF18	VSS	AF20
AF20	VSS	AF22
AF22	VSS	AF24
AF24	VSS	AY1
AY1	VSS	BC4
BC4	VSS	

945G/A2[10HB1-033000-22R]

VSS	AU21
VSS	AU24
VSS	AU26
VSS	AU29
VSS	AU32
VSS	AU34
VSS	AV2
VSS	AV10
VSS	AV17
VSS	AV37
VSS	AW10
VSS	BA4
VSS	BA42
VSS	BB3
VSS	BB6
VSS	BB11
VSS	BB14
VSS	BB19
VSS	BB34
VSS	BB39
VSS	BB41
VSS	BC9
VSS	A40
VSS	D1
VSS	D43
VSS	R26
VSS	R29
VSS	U29
VSS	V24
VSS	V26
VSS	V29
VSS	W21
VSS	W23
VSS	W25
VSS	Y20
VSS	Y22
VSS	Y24
VSS	Y26
VSS	Y29
VSS	AA25
VSS	AA27
VSS	AA29
VSS	AC19
VSS	AC25
VSS	AC29
NC	A42
NC	B2
NC	B3
NC	B4
NC	B42
NC	B43
NC	C2
NC	C4
NC	E35
NC	AV26
NC	AV27
NC	AW2
NC	AW28
NC	BA2
NC	BB1
NC	BB2
NC	BB43
NC	BB44
NC	BC1
NC	BC2
NC	BC42
NC	BC43
RSVD	AK21
RSVD	AJ23
RSVD	AJ26
RSVD	AL23
RSVD	AL29
RSVD	AL30
RSVD	AJ21
RSVD	AL28
RSVD	AK27
RSVD	AD36
RSVD	AC34
RSVD	Y30
RSVD	Y32
RSVD	AF31
RSVD	AD31
RSVD	U30
RSVD	V31
RSVD	AA30
RSVD	AC30
RSVD	AA3
RSVD	AG25
RSVD	AG26
RSVD	AG27
RSVD	AJ24
RSVD	AJ27
RSVD	AK40
RSVD	AW17
RSVD	AW18
RSVD	AY14
RSVD	BC16
RSVD	AJ29
RSVD	AG23

1.425~1.575V

- VCC1\_5
- N17
- P17
- P18
- P20
- P21
- AA22
- AB21
- AB22
- AB23
- AC22
- AD14
- AF6
- AF7
- AF8
- AF9
- AF10
- AF11
- AF12
- AF13
- AF14
- AF30
- AG2
- AG3
- AG4
- AG5
- AG6
- AG7
- AG8
- AG9
- AG10
- AG11
- AG12
- AG13
- AG14
- AH1
- AH2
- AH4
- AJ5
- AJ13
- AJ14
- AK3
- AK4
- AK14
- AK15
- AK20
- R15
- R17
- R18
- R20
- R21
- R23
- R24
- U15
- U17
- U18
- U19
- U20
- U21
- U22
- U23
- U24
- U25
- U26
- V15
- V17
- V18
- V19
- V20
- V21
- V22
- V23
- V25
- V27
- W17
- W18
- W19
- W20
- W22
- W24
- W26
- W27
- Y15
- Y17
- Y18
- Y19
- Y21
- Y23
- Y25
- Y27
- AA15
- AA17
- AA18
- AA19
- AA20
- AA24
- AA26
- AB17
- AB18
- AB19
- AB20
- AB24
- AB25
- AB26
- AB27
- AC15
- AC17
- AC18
- AC20
- AC24
- AC26
- AC27
- AD15
- AD17
- AD19
- AD21
- AD23
- AD25
- AD26
- AE17
- AE18
- AE20
- AE22
- AE24
- AE26
- AE27
- AE15
- AE17
- AE19
- AE21
- AE23
- AE25
- AE26
- AE27
- AE29

1.7~1.9V

- BB16
- AW15
- BB42
- BB43
- BC18
- BC22
- BC26
- BB20
- AW24
- BB46
- BC31
- BB38
- BB33
- BB28
- BB24
- BB22
- AW29
- AW31
- AW34
- AX41
- AW42
- AW23
- AW18
- BC40
- AW38
- AX43
- AW20
- AW21
- AW31
- AW13
- AW21

1.14~1.26V

- VTT
- G23
- E23
- D23
- D24
- D25
- B25
- B24
- B23
- B26
- H23
- I23
- K23
- L23
- M23
- E24
- N23
- A24
- F23
- E27
- E26
- C25
- C26
- VTT

2.375~2.625V

- B19
- B20
- C21
- C19
- B18
- C18
- D19
- B17
- A18

1.425~1.575V

- AA13
- AD12
- AC5
- AA5
- U13
- V5
- V13
- AE2
- R13
- N12
- N10
- R6
- N7
- N11
- AE3
- N9
- AD10
- AD1
- AC6
- AD8
- AD2
- AD4
- AD5
- AD6
- Y13
- N6
- U8
- AC13
- AE4
- L7
- R10
- R11
- U6
- V6
- V7
- V9
- V10

VCCA\_EXPPLL=VCCA\_GPLL=45mA(1.425V~1.575V)



VCCA\_HPLL>50mA 公板為200mA(1.425V~1.575V)



VCCA\_DPLL=65mA(1.425V~1.575V)



VCCA\_DPLLB=65mA(1.425V~1.575V)



VCCA\_MPLL>50mA(1.425V~1.575V)

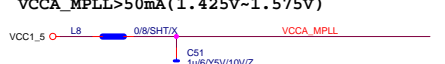

VCCA\_DAC=DDR25V\_DAC=70mA(2.375~2.625V)

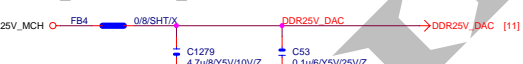

945 Design Guide rev1.5 spec.  
 VCCA\_EXPPLL=VCCA\_GPLL=45mA(1.425V~1.575V)  
 VCCA\_HPLL>50mA 公板為200mA(1.425V~1.575V)  
 VCCA\_DPLL=65mA(1.425V~1.575V)  
 VCCA\_DPLLB=65mA(1.425V~1.575V)  
 VCCA\_MPLL>50mA(1.425V~1.575V)  
 VCCA\_DAC=DDR25V\_DAC=70mA(2.375~2.625V)

<b>Gigabyte Technology</b>		
Title	GMCH-PWR	
Size	Document Number	Rev
Custom	<b>81945GME</b>	<b>1.0</b>
Date:	Monday, October 31, 2005	Sheet 13 of 33

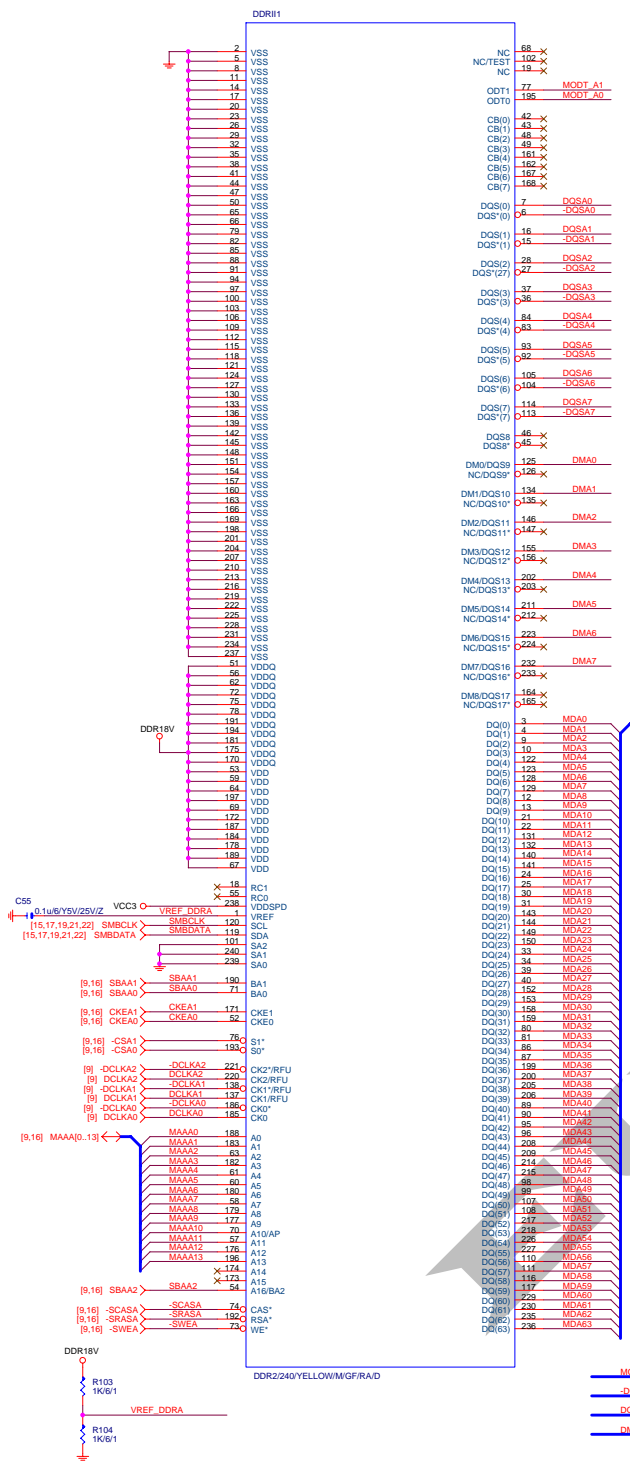



# DDR TERMINATION CHANNEL A

## DDRVTT Decouple

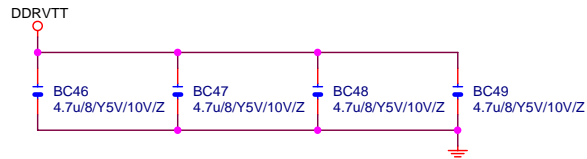
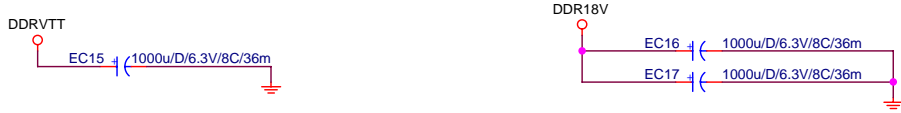

## DDR18V Decouple

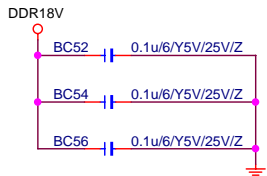

## DDRVTT Decouple

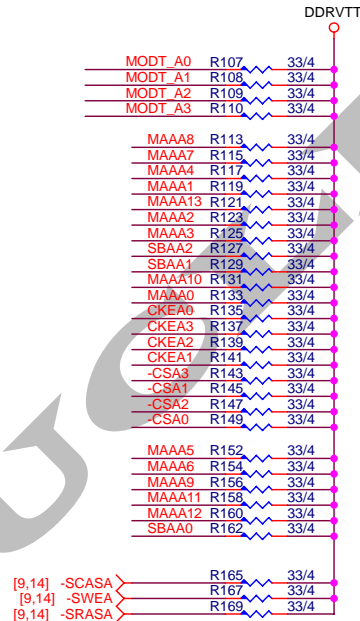
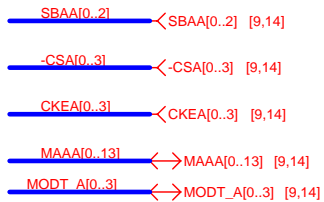
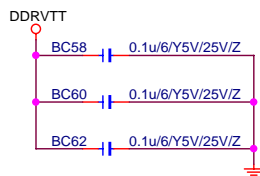

# DDR TERMINATION CHANNEL B

## DDR18V Decouple

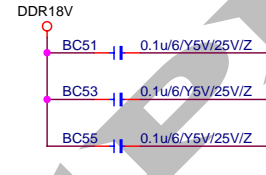

## DDRVTT Decouple

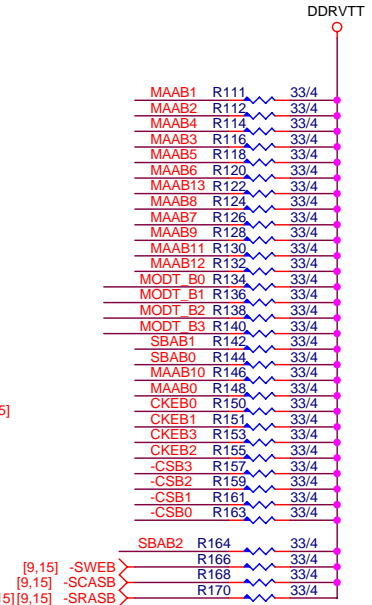
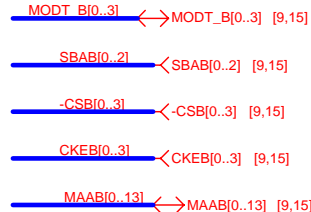
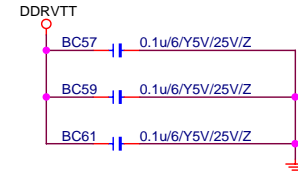

Gigabyte Technology

Title		
DDRII TERMINATOR		
Size Custom	Document Number	Rev
	8I945GME	1.0
Date:	Monday, October 31, 2005	Sheet 16 of 33



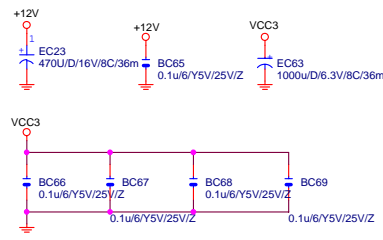

PCIESLOT-164DN-2

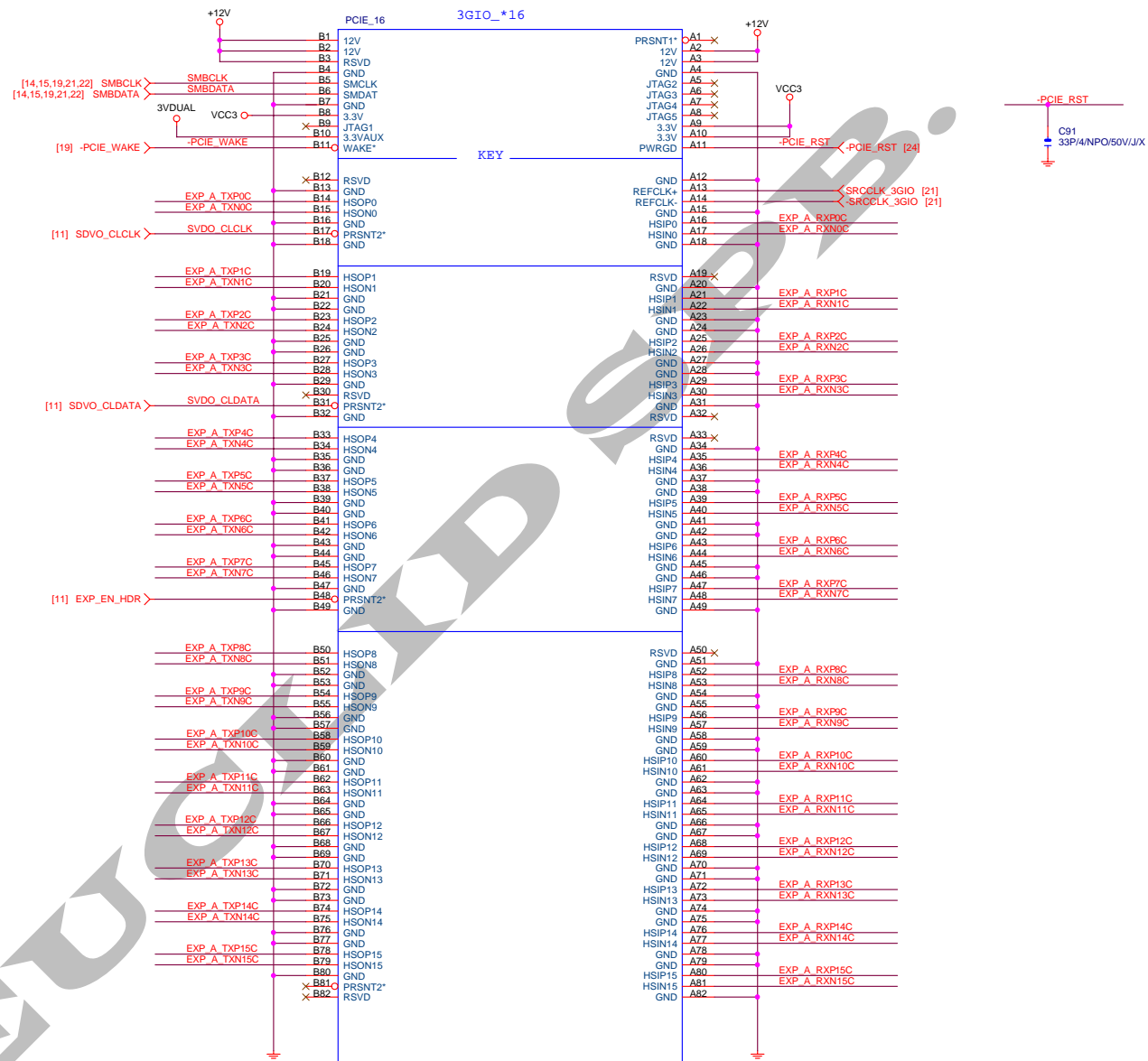

EXP A TXP0\_15 >> EXP\_A\_TXP[0..15] [10]  
 EXP A TXN0\_15 >> EXP\_A\_TXN[0..15] [10]  
 EXP A RXP0\_15 >> EXP\_A\_RXP[0..15] [10]  
 EXP A RXN0\_15 >> EXP\_A\_RXN[0..15] [10]

EXP A TXP0	C92	0.1u/6Y5V/25V/Z	EXP A TXP0C
EXP A TXN0	C93	0.1u/6Y5V/25V/Z	EXP A TXN0C
EXP A TXP1	C94	0.1u/6Y5V/25V/Z	EXP A TXP1C
EXP A TXN1	C95	0.1u/6Y5V/25V/Z	EXP A TXN1C
EXP A TXP2	C96	0.1u/6Y5V/25V/Z	EXP A TXP2C
EXP A TXN2	C97	0.1u/6Y5V/25V/Z	EXP A TXN2C
EXP A TXP3	C98	0.1u/6Y5V/25V/Z	EXP A TXP3C
EXP A TXN3	C99	0.1u/6Y5V/25V/Z	EXP A TXN3C
EXP A TXP4	C100	0.1u/6Y5V/25V/Z	EXP A TXP4C
EXP A TXN4	C101	0.1u/6Y5V/25V/Z	EXP A TXN4C
EXP A TXP5	C102	0.1u/6Y5V/25V/Z	EXP A TXP5C
EXP A TXN5	C103	0.1u/6Y5V/25V/Z	EXP A TXN5C
EXP A TXP6	C104	0.1u/6Y5V/25V/Z	EXP A TXP6C
EXP A TXN6	C105	0.1u/6Y5V/25V/Z	EXP A TXN6C
EXP A TXP7	C106	0.1u/6Y5V/25V/Z	EXP A TXP7C
EXP A TXN7	C107	0.1u/6Y5V/25V/Z	EXP A TXN7C
EXP A TXP8	C108	0.1u/6Y5V/25V/Z	EXP A TXP8C
EXP A TXN8	C109	0.1u/6Y5V/25V/Z	EXP A TXN8C
EXP A TXP9	C110	0.1u/6Y5V/25V/Z	EXP A TXP9C
EXP A TXN9	C111	0.1u/6Y5V/25V/Z	EXP A TXN9C
EXP A TXP10	C112	0.1u/6Y5V/25V/Z	EXP A TXP10C
EXP A TXN10	C113	0.1u/6Y5V/25V/Z	EXP A TXN10C
EXP A TXP11	C114	0.1u/6Y5V/25V/Z	EXP A TXP11C
EXP A TXN11	C115	0.1u/6Y5V/25V/Z	EXP A TXN11C
EXP A TXP12	C116	0.1u/6Y5V/25V/Z	EXP A TXP12C
EXP A TXN12	C117	0.1u/6Y5V/25V/Z	EXP A TXN12C
EXP A TXP13	C118	0.1u/6Y5V/25V/Z	EXP A TXP13C
EXP A TXN13	C119	0.1u/6Y5V/25V/Z	EXP A TXN13C
EXP A TXP14	C120	0.1u/6Y5V/25V/Z	EXP A TXP14C
EXP A TXN14	C121	0.1u/6Y5V/25V/Z	EXP A TXN14C
EXP A TXP15	C122	0.1u/6Y5V/25V/Z	EXP A TXP15C
EXP A TXN15	C123	0.1u/6Y5V/25V/Z	EXP A TXN15C

EXP A RXP0	SR1	0/4	EXP A RXP0C
EXP A RXN0	SR2	0/4	EXP A RXN0C
EXP A RXP1	SR3	0/4	EXP A RXP1C
EXP A RXN1	SR4	0/4	EXP A RXN1C
EXP A RXP2	SR5	0/4	EXP A RXP2C
EXP A RXN2	SR6	0/4	EXP A RXN2C
EXP A RXP3	SR7	0/4	EXP A RXP3C
EXP A RXN3	SR8	0/4	EXP A RXN3C
EXP A RXP4	SR9	0/4	EXP A RXP4C
EXP A RXN4	SR10	0/4	EXP A RXN4C
EXP A RXP5	SR11	0/4	EXP A RXP5C
EXP A RXN5	SR12	0/4	EXP A RXN5C
EXP A RXP6	SR13	0/4	EXP A RXP6C
EXP A RXN6	SR14	0/4	EXP A RXN6C
EXP A RXP7	SR15	0/4	EXP A RXP7C
EXP A RXN7	SR16	0/4	EXP A RXN7C
EXP A RXP8	SR17	0/4	EXP A RXP8C
EXP A RXN8	SR18	0/4	EXP A RXN8C
EXP A RXP9	SR19	0/4	EXP A RXP9C
EXP A RXN9	SR20	0/4	EXP A RXN9C
EXP A RXP10	SR21	0/4	EXP A RXP10C
EXP A RXN10	SR22	0/4	EXP A RXN10C
EXP A RXP11	SR23	0/4	EXP A RXP11C
EXP A RXN11	SR24	0/4	EXP A RXN11C
EXP A RXP12	SR25	0/4	EXP A RXP12C
EXP A RXN12	SR26	0/4	EXP A RXN12C
EXP A RXP13	SR27	0/4	EXP A RXP13C
EXP A RXN13	SR28	0/4	EXP A RXN13C
EXP A RXP14	SR29	0/4	EXP A RXP14C
EXP A RXN14	SR30	0/4	EXP A RXN14C
EXP A RXP15	SR31	0/4	EXP A RXP15C
EXP A RXN15	SR32	0/4	EXP A RXN15C

[18] PCIE_OP0	PCIE_OP0	SR49	0/4/X	EXP A TXP0C
[18] PCIE_ON0	PCIE_ON0	SR50	0/4/X	EXP A TXN0C
[18] PCIE_OP1	PCIE_OP1	SR51	0/4/X	EXP A TXP1C
[18] PCIE_ON1	PCIE_ON1	SR52	0/4/X	EXP A TXN1C
[18] PCIE_OP2	PCIE_OP2	SR53	0/4/X	EXP A TXP2C
[18] PCIE_ON2	PCIE_ON2	SR54	0/4/X	EXP A TXN2C
[18] PCIE_OP3	PCIE_OP3	SR55	0/4/X	EXP A TXP3C
[18] PCIE_ON3	PCIE_ON3	SR56	0/4/X	EXP A TXN3C

[18] PCIE_IP0	PCIE_IP0	SR53	0/4/X	EXP A RXP0C
[18] PCIE_IN0	PCIE_IN0	SR54	0/4/X	EXP A RXN0C
[18] PCIE_IP1	PCIE_IP1	SR55	0/4/X	EXP A RXP1C
[18] PCIE_IN1	PCIE_IN1	SR56	0/4/X	EXP A RXN1C
[18] PCIE_IP2	PCIE_IP2	SR57	0/4/X	EXP A RXP2C
[18] PCIE_IN2	PCIE_IN2	SR58	0/4/X	EXP A RXN2C
[18] PCIE_IP3	PCIE_IP3	SR59	0/4/X	EXP A RXP3C
[18] PCIE_IN3	PCIE_IN3	SR60	0/4/X	EXP A RXN3C

**Gigabyte Technology**

**PCI EXPRESS \* 16**

Title	Document Number	Rev
	<b>81945GME</b>	<b>1.0</b>
Date:	Monday, October 31, 2005	Sheet 17 of 33





A4	VSS1	VSS101	R14
A23	VSS2	VSS102	R15
B1	VSS3	VSS103	R16
B8	VSS4	VSS104	R17
B11	VSS5	VSS105	R18
B14	VSS6	VSS106	T6
B17	VSS7	VSS107	T12
B20	VSS8	VSS108	T13
B26	VSS9	VSS109	T14
B28	VSS10	VSS110	T15
C2	VSS11	VSS111	T16
C6	VSS12	VSS112	T17
D10	VSS13	VSS113	U4
D13	VSS14	VSS114	U12
D18	VSS15	VSS115	U13
D21	VSS16	VSS116	U14
D24	VSS17	VSS117	U15
E1	VSS18	VSS118	U16
E2	VSS19	VSS119	U17
E8	VSS20	VSS120	U24
E15	VSS21	VSS121	U25
F3	VSS22	VSS122	U26
F4	VSS23	VSS123	U27
F6	VSS24	VSS124	V15
F12	VSS25	VSS125	V24
F27	VSS26	VSS126	V28
F28	VSS27	VSS127	V29
G1	VSS28	VSS128	W6
G2	VSS29	VSS129	W24
G5	VSS30	VSS130	W25
G6	VSS31	VSS131	W26
G9	VSS32	VSS132	Y3
G14	VSS33	VSS133	Y24
G18	VSS34	VSS134	Y27
G21	VSS35	VSS135	Y28
G24	VSS36	VSS136	AA1
G25	VSS37	VSS137	AA24
G26	VSS38	VSS138	AA25
H3	VSS39	VSS139	AA26
H4	VSS40	VSS140	AB4
H5	VSS41	VSS141	AB6
H24	VSS42	VSS142	AB11
H27	VSS43	VSS143	AB14
H28	VSS44	VSS144	AB16
J1	VSS45	VSS145	AB19
J2	VSS46	VSS146	AB21
J5	VSS47	VSS147	AB24
J25	VSS48	VSS148	AB27
J26	VSS49	VSS149	AB28
J26	VSS50	VSS150	AC2
K24	VSS51	VSS151	AC5
K27	VSS52	VSS152	AC9
K28	VSS53	VSS153	AC11
L13	VSS54	VSS154	AD1
L15	VSS55	VSS155	AD3
L24	VSS56	VSS156	AD4
L25	VSS57	VSS157	AD7
L26	VSS58	VSS158	AD8
M3	VSS59	VSS159	AD11
M4	VSS60	VSS160	AD15
M5	VSS61	VSS161	AD19
M12	VSS62	VSS162	AD23
M13	VSS63	VSS163	AE2
M14	VSS64	VSS164	AE4
M15	VSS65	VSS165	AE8
M16	VSS66	VSS166	AE11
M17	VSS67	VSS167	AE13
M24	VSS68	VSS168	AE18
M27	VSS69	VSS169	AE21
M28	VSS70	VSS170	AE24
N1	VSS71	VSS171	AE25
N2	VSS72	VSS172	AF2
N5	VSS73	VSS173	AF4
N6	VSS74	VSS174	AF8
N11	VSS75	VSS175	AF11
N12	VSS76	VSS176	AF27
N13	VSS77	VSS177	AF28
N14	VSS78	VSS178	AG1
N16	VSS79	VSS179	AG3
N17	VSS80	VSS180	AG7
N17	VSS81	VSS181	AG14
N18	VSS82	VSS182	AG17
N24	VSS83	VSS183	AG20
N25	VSS84	VSS184	AG25
N26	VSS85	VSS185	AH1
P3	VSS86	VSS186	AH3
P4	VSS87	VSS187	AH7
P12	VSS88	VSS188	AH12
P13	VSS89	VSS189	AH23
P14	VSS90	VSS190	AH27
P15	VSS91	VSS191	C27
P17	VSS92	VSS192	E4
P24	VSS94	VSS194	AG11
P27	VSS95		
P28	VSS96		
R1	VSS97		
R11	VSS98		
R12	VSS99		
R13	VSS100		

ICH7/A1[10HB1-032801-N2R]

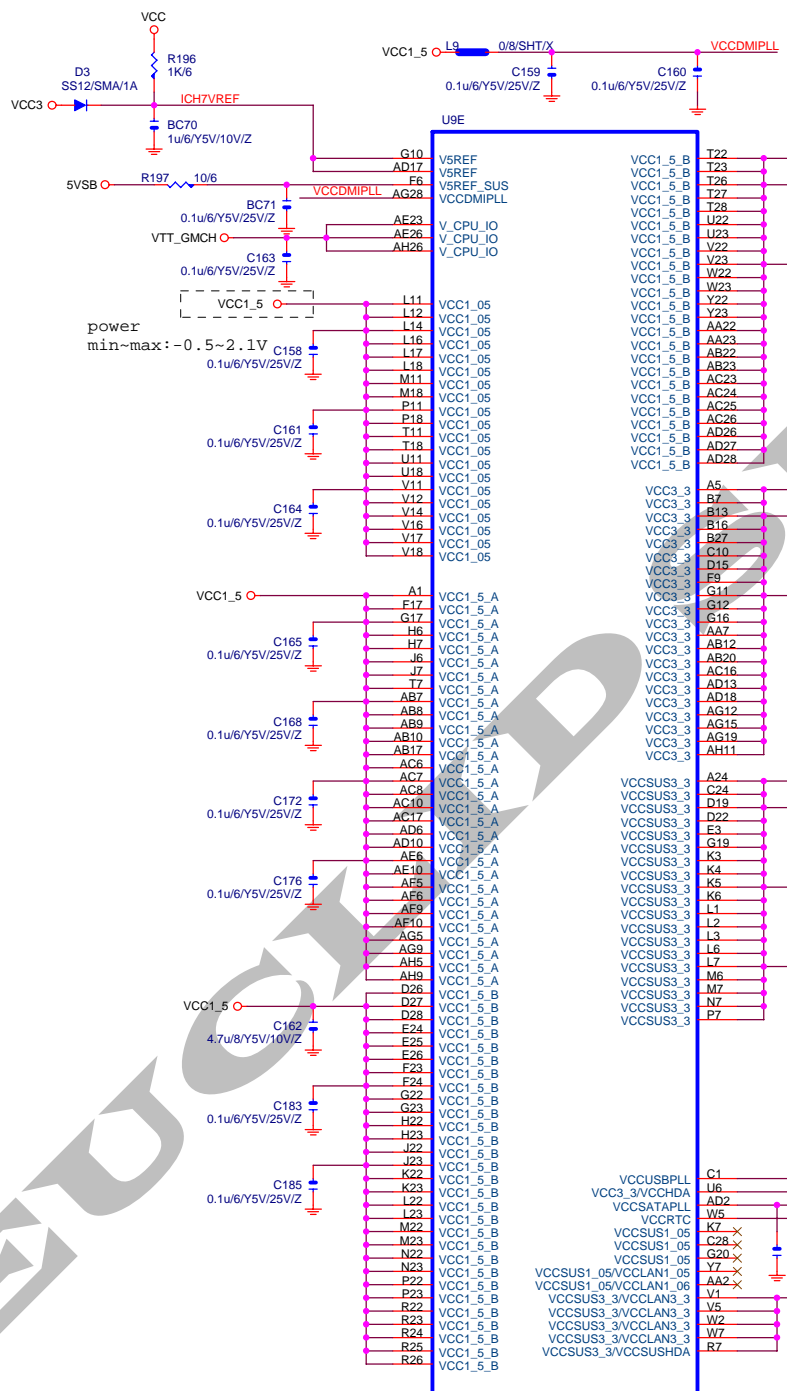

ICH7/A1[10HB1-032801-N2R]

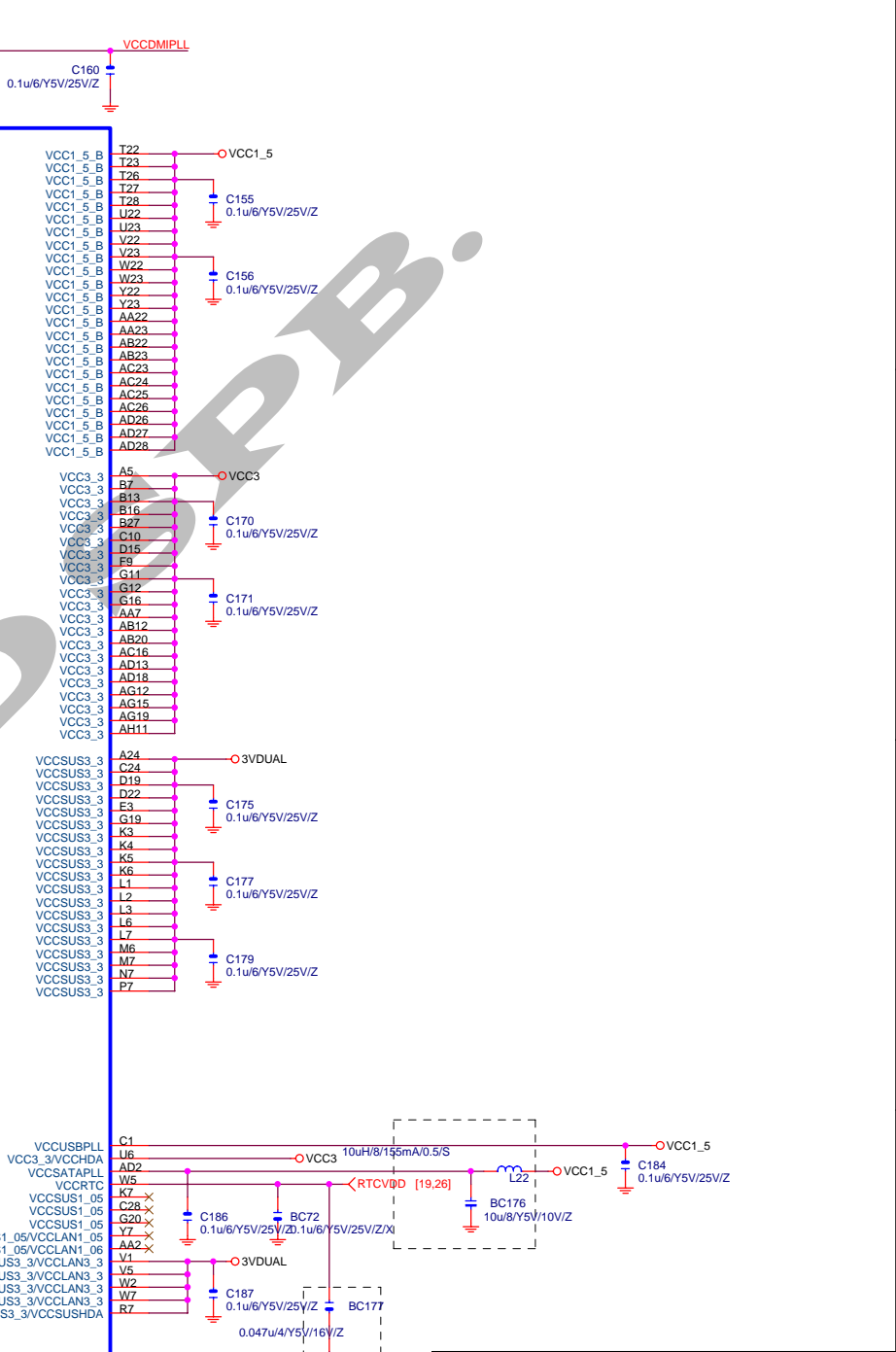

**Gigabyte Technology**

**ICH6-PWR & GND**

Title		ICH6-PWR & GND	
Size	Document Number	<b>81945GME</b>	
B		Rev 1.0	
Date:	Monday, October 31, 2005	Sheet	20 of 33

FOR 漏電

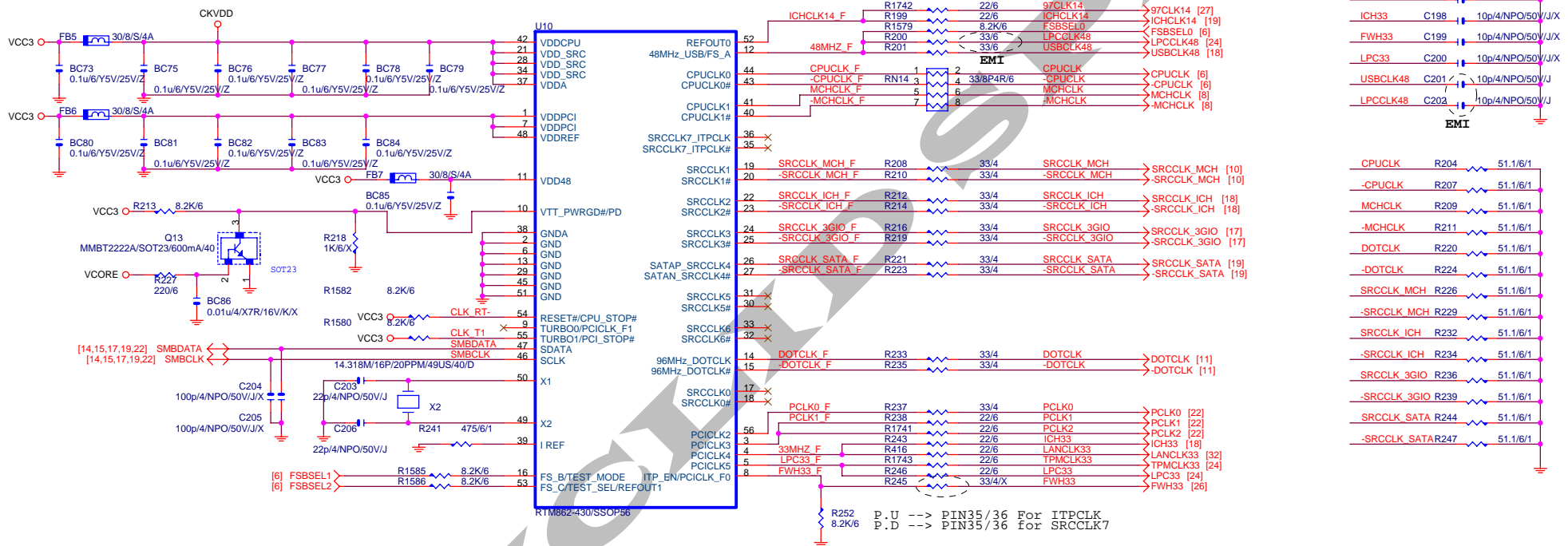

- 97CLK14 C1334 10p4/NPO/50V/JJX
- ICHCLK14 C193 10p4/NPO/50V/JJX
- LANCLK33 C261 10p4/NPO/50V/JJX
- PCLK0 C195 10p4/NPO/50V/JJX
- PCLK1 C196 10p4/NPO/50V/JJX
- PCLK2 C1333 10p4/NPO/50V/JJX
- ICH33 C198 10p4/NPO/50V/JJX
- FWH33 C199 10p4/NPO/50V/JJX
- LPC33 C200 10p4/NPO/50V/JJX
- USBCLK48 C201 10p4/NPO/50V/JJX
- LPCCLK48 C202 10p4/NPO/50V/JJX
- EMITTER
- CPUCCLK R204 51.1/6/1
- CPUCCLK R207 51.1/6/1
- MCHCLK R209 51.1/6/1
- MCHCLK R211 51.1/6/1
- DOTCLK R220 51.1/6/1
- DOTCLK R224 51.1/6/1
- SRCCLK\_MCH R226 51.1/6/1
- SRCCLK\_MCH R229 51.1/6/1
- SRCCLK\_ICH R234 51.1/6/1
- SRCCLK\_ICH R236 51.1/6/1
- SRCCLK\_3GIO R239 51.1/6/1
- SRCCLK\_SATA R244 51.1/6/1
- SRCCLK\_SATA R247 51.1/6/1



**PCI1, 2 SLOT**

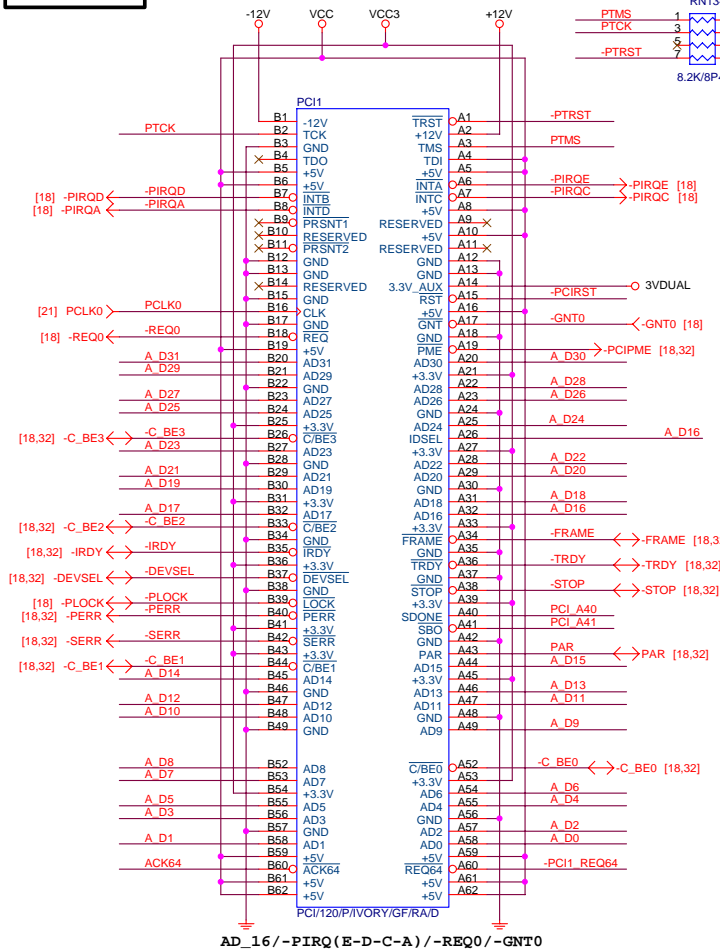

AD\_16/-PIRQ(E-D-C-A)/-REQ0/-GNT0

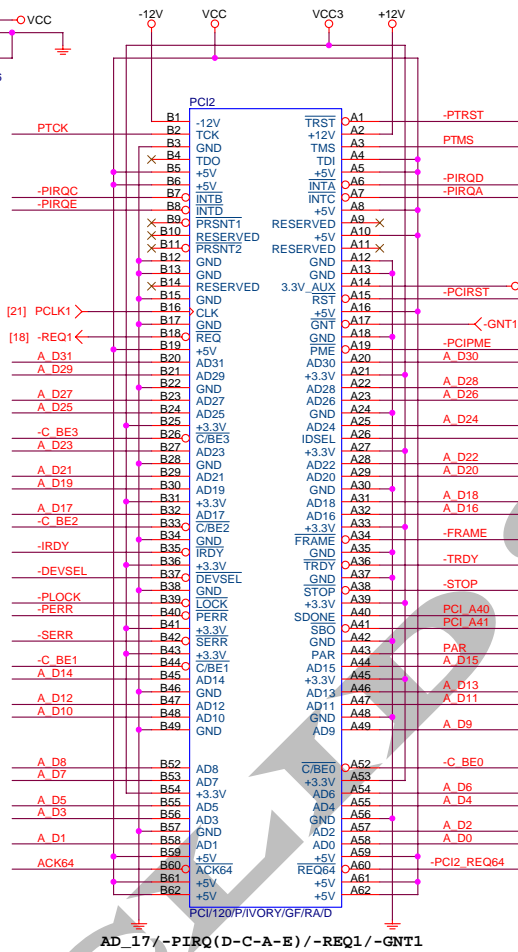

AD\_17/-PIRQ(D-C-A-E)/-REQ1/-GNT1

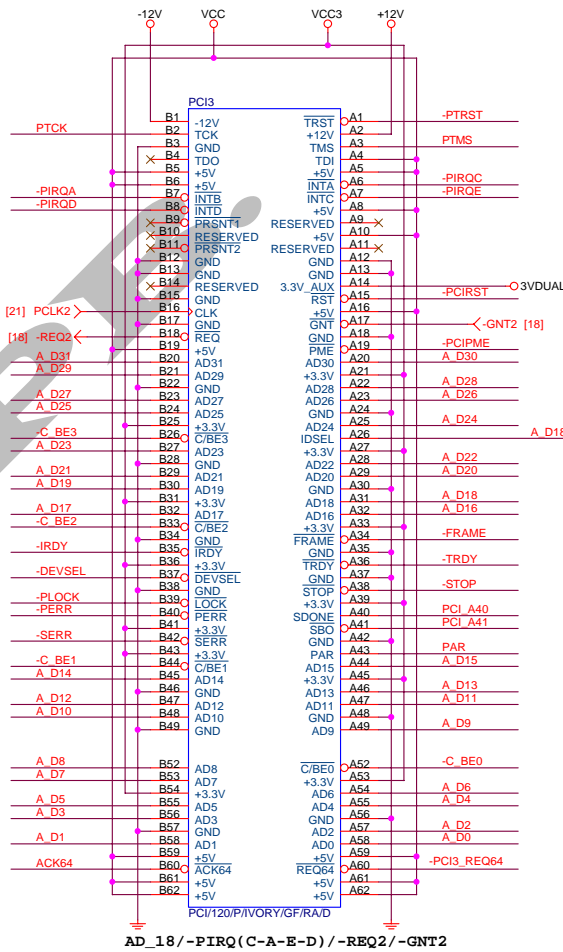

AD\_18/-PIRQ(C-A-E-D)/-REQ2/-GNT2

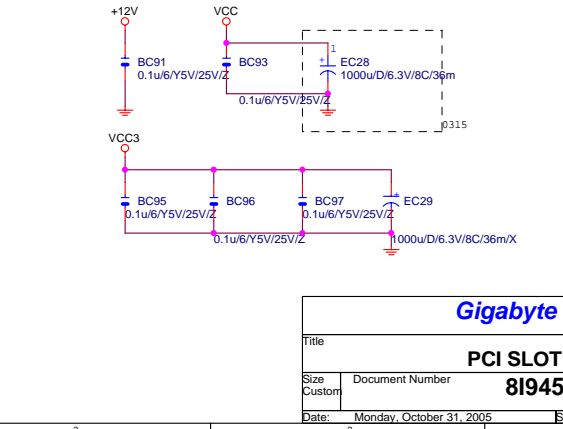
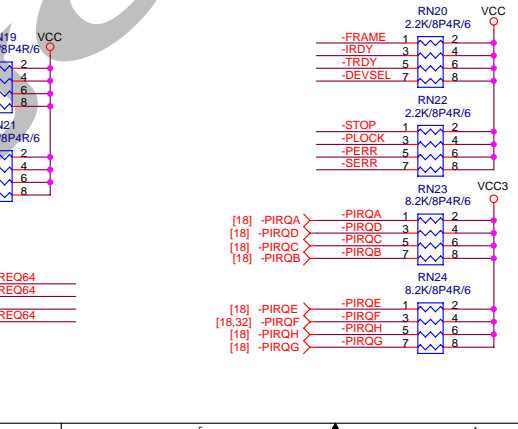
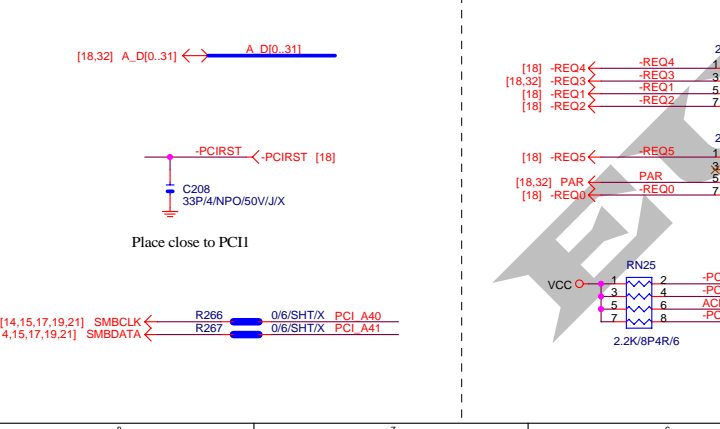

**Gigabyte Technology**

Title			PCI SLOT 1, 2/PCIEX1		
Size			81945GME		
Document Number			Rev 1.0		
Date:	Monday, October 31, 2005	Sheet	22	of	33

**IDE/SATA LED**

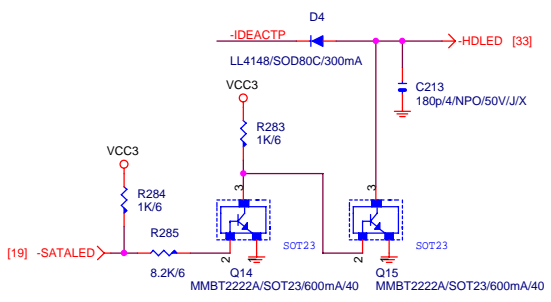

**IDE RESET**

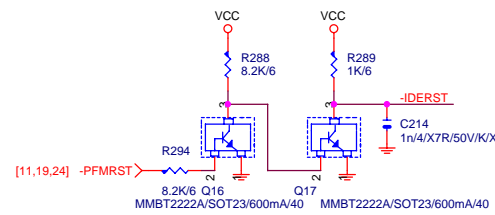

**FLOPPY**

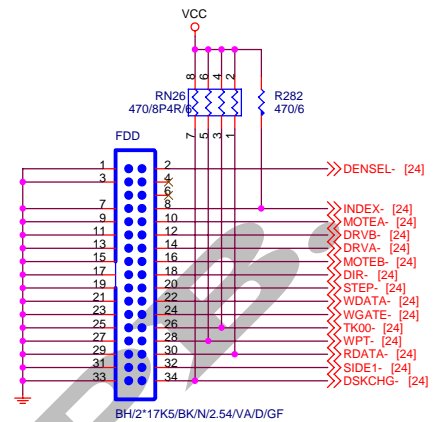

**IDE**

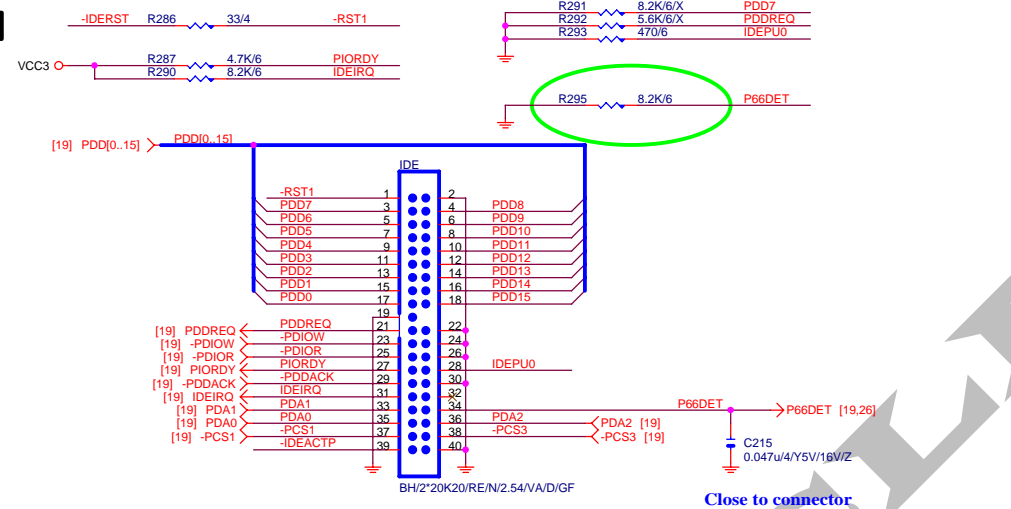

**FRONT USB1**

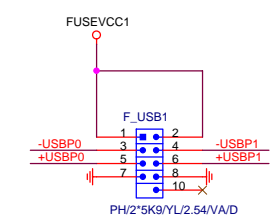
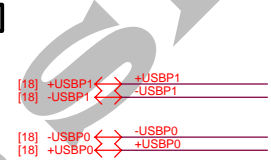

**FRONT USB2**

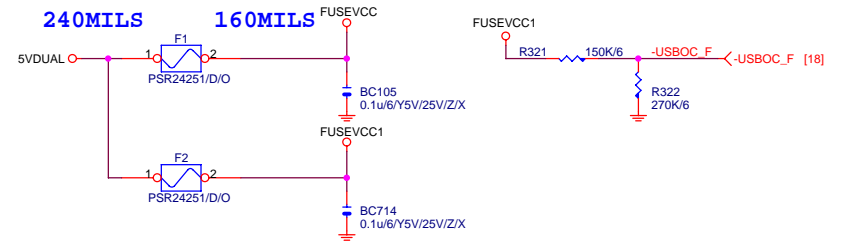
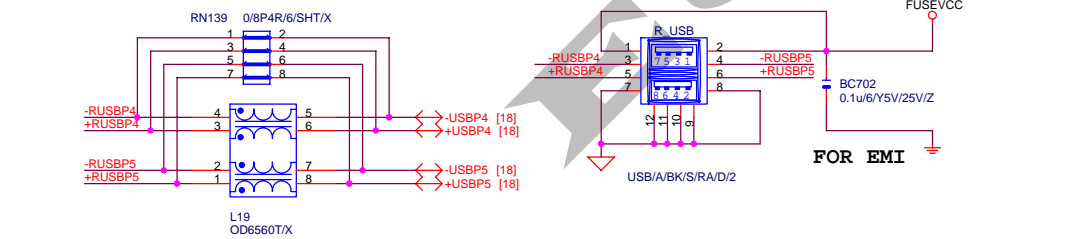
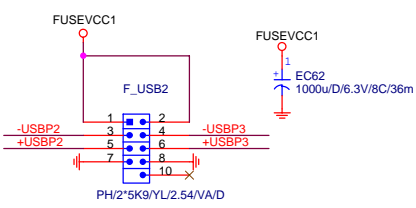
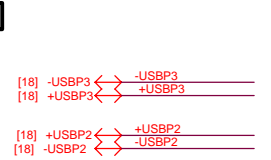

RTS2- ==LOW CPU FAN 50%  
 ==HIGH 100%  
**DEFAULT 50%**

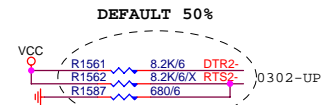

SOUT2	1	VID pins threshold voltage select: Vih / Vil : 2.0 / 0.8V
	0	VID pins threshold voltage select: Vih / Vil : 0.8 / 0.4V

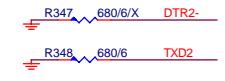

**1.2V or 3.3V tolerance select.**  
 1.2V OUTPUT 接 VTT\_GMCH  
 3.3V OUTPUT 接 3.3V  
 LPCPD#=-VIDVCC

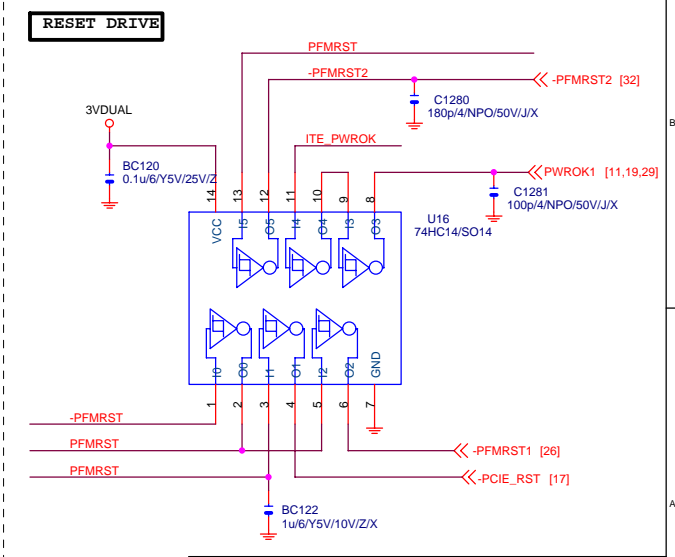
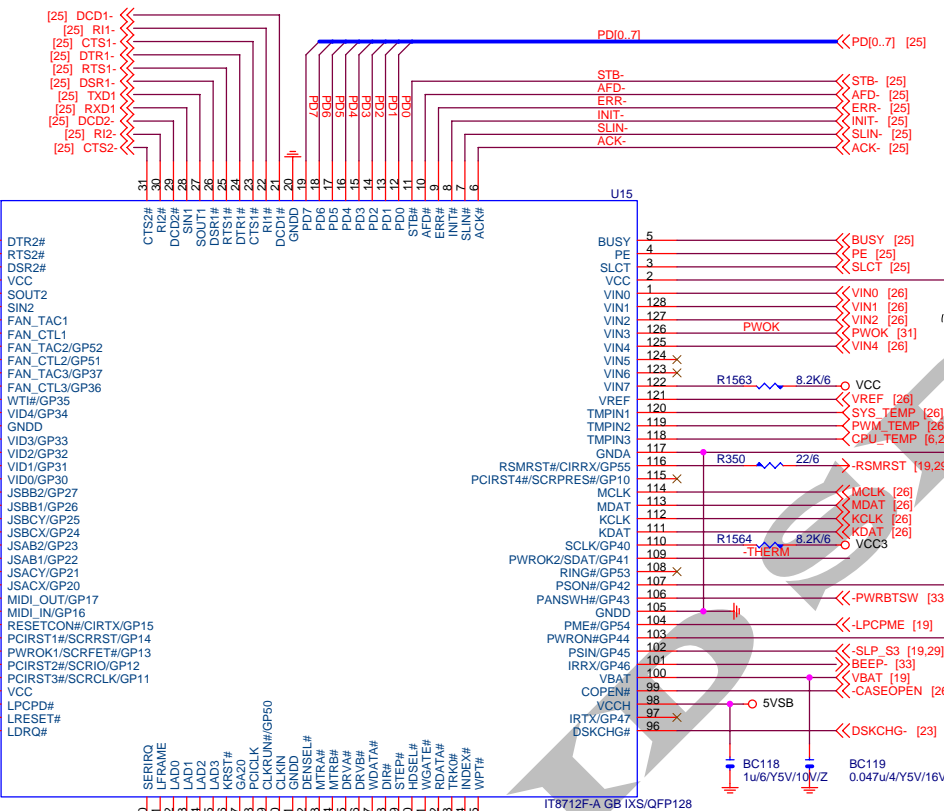
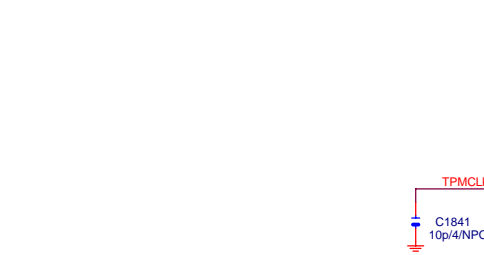
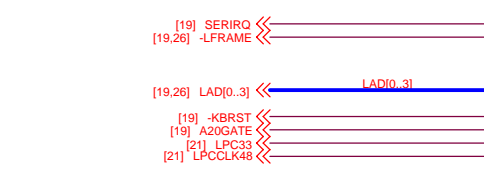
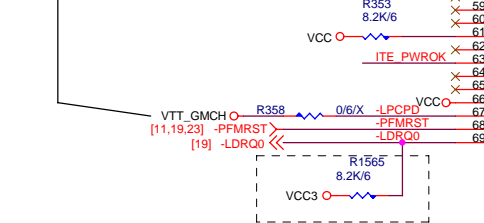

Gigabyte Technology		
Title		
<b>ITE 8712 LPC IO</b>		
Size B	Document Number	Rev
	<b>81945GME</b>	<b>1.0</b>
Date:	Monday, October 31, 2005	Sheet 24 of 33





**TEMP H/W MONITOR**

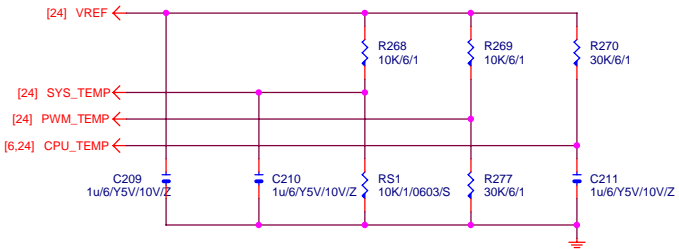

**VOLTAGE-- H/W MONITOR**

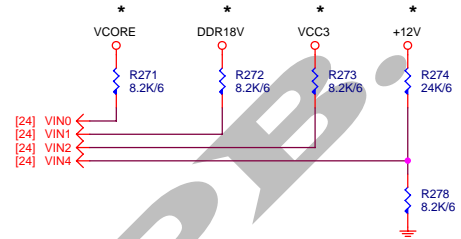

**CASE OPEN**

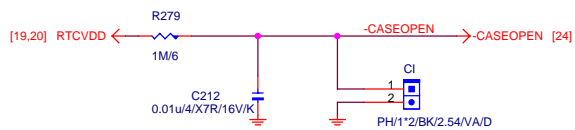

Case Open Circuits

**KB/MS**

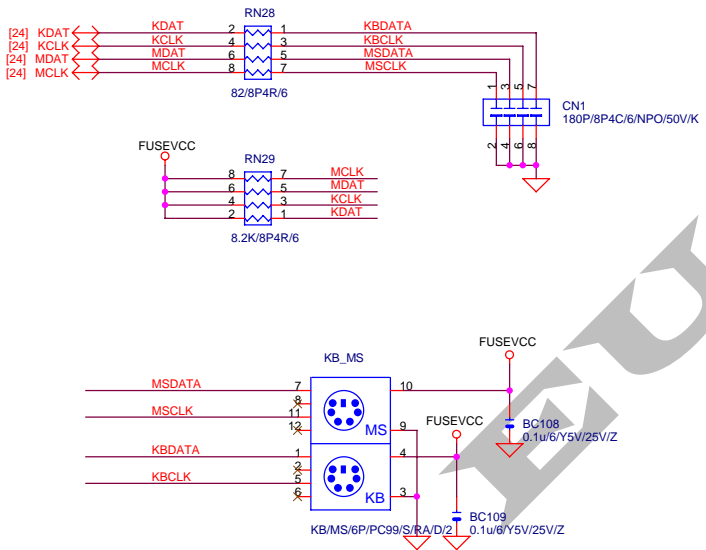

**FWM BIOS**

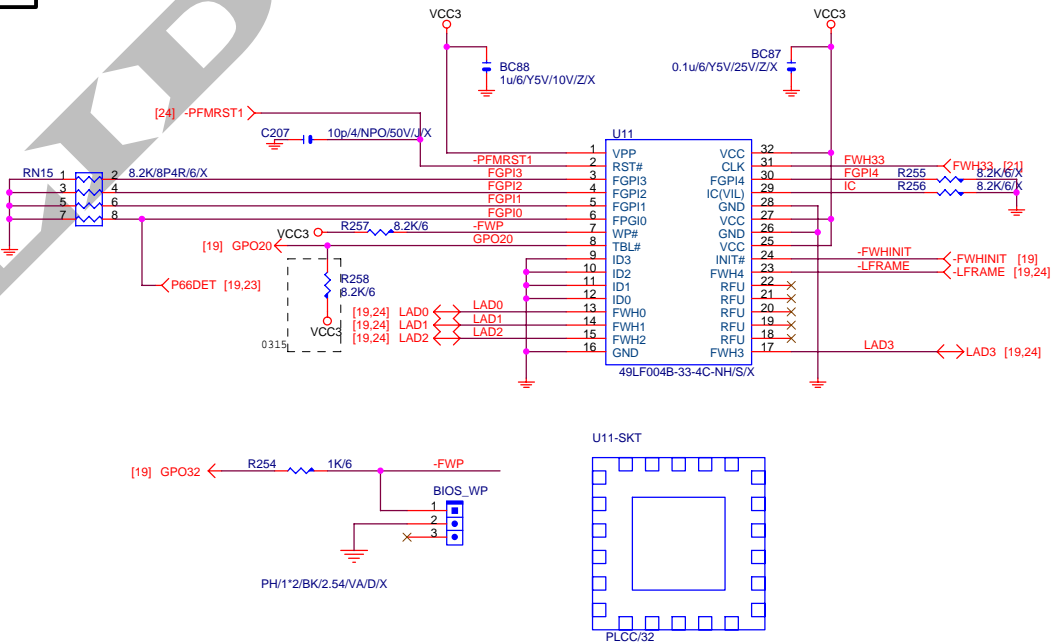

**Gigabyte Technology**

Title		
<b>BIOS/HW-MONITOR/CI/KB/MS</b>		
Size	Document Number	Rev
B	<b>81945GME</b>	<b>1.0</b>
Date:	Monday, October 31, 2005	Sheet 26 of 33

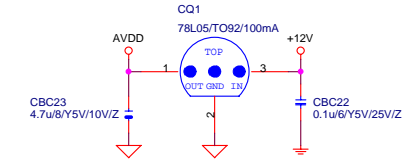
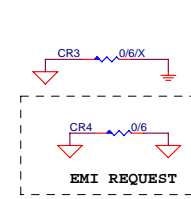
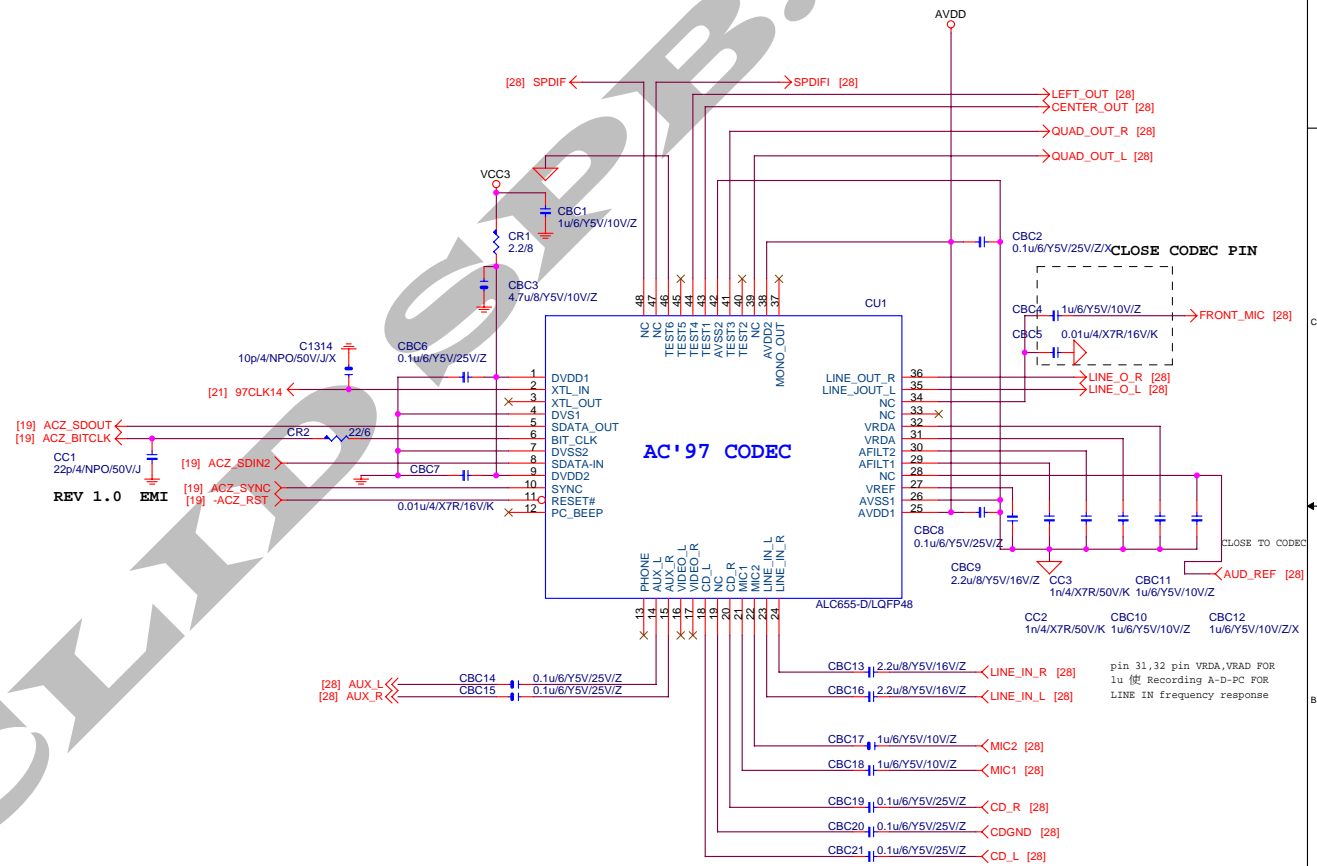

<b>Gigabyte Technology</b>		
<b>AUDIO (ALC655)</b>		
Title		
Size	Document Number	Rev
Custom	<b>8I945GME</b>	<b>1.0</b>
Date:	Monday, October 31, 2005	Sheet 27 of 33

### INTEL FRONT AUDIO

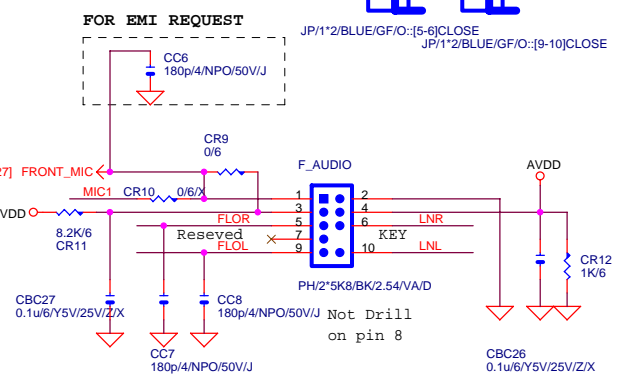

### CD IN

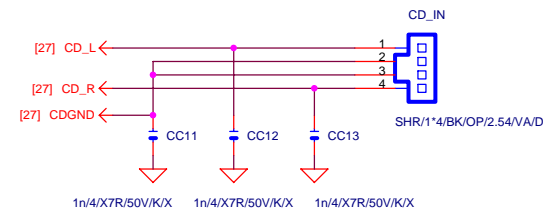

### AUX IN

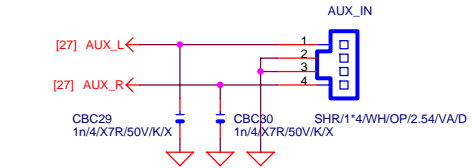

### SUR\_CEN

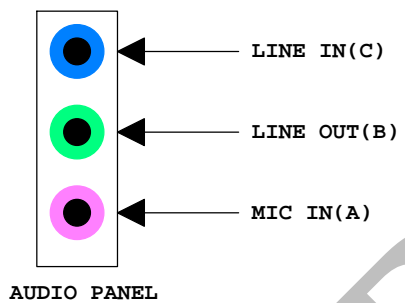
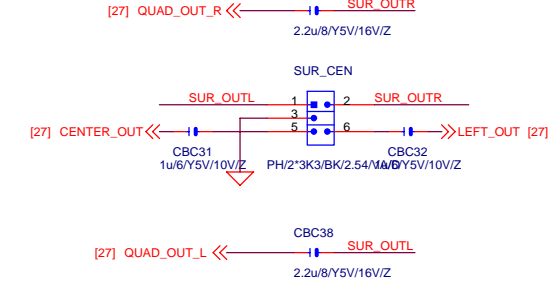

### SPDIF\_IO

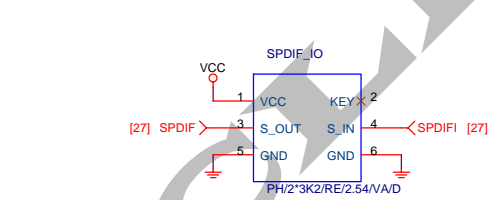

### LINE OUT

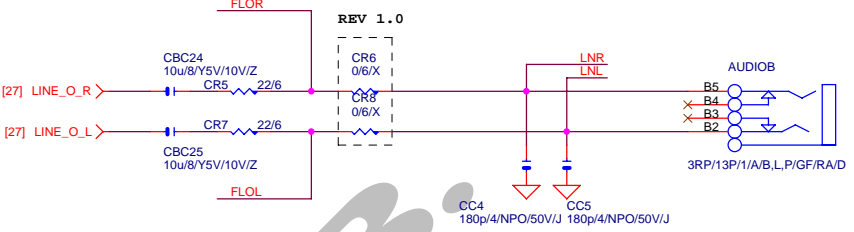

### LINE-IN

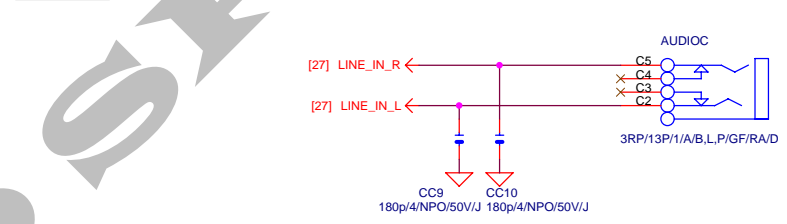

### MIC

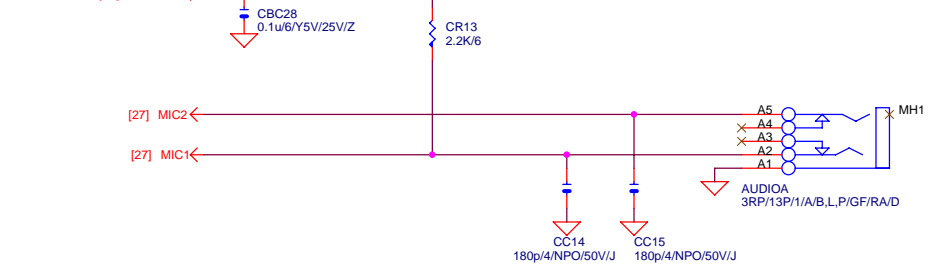

<b>Gigabyte Technology</b>		
<b>AUDIO OUTPUT</b>		
Size Custom	Document Number	Rev
	<b>8I945GME</b>	<b>1.0</b>
Date:	Monday, October 31, 2005	Sheet 28 of 33



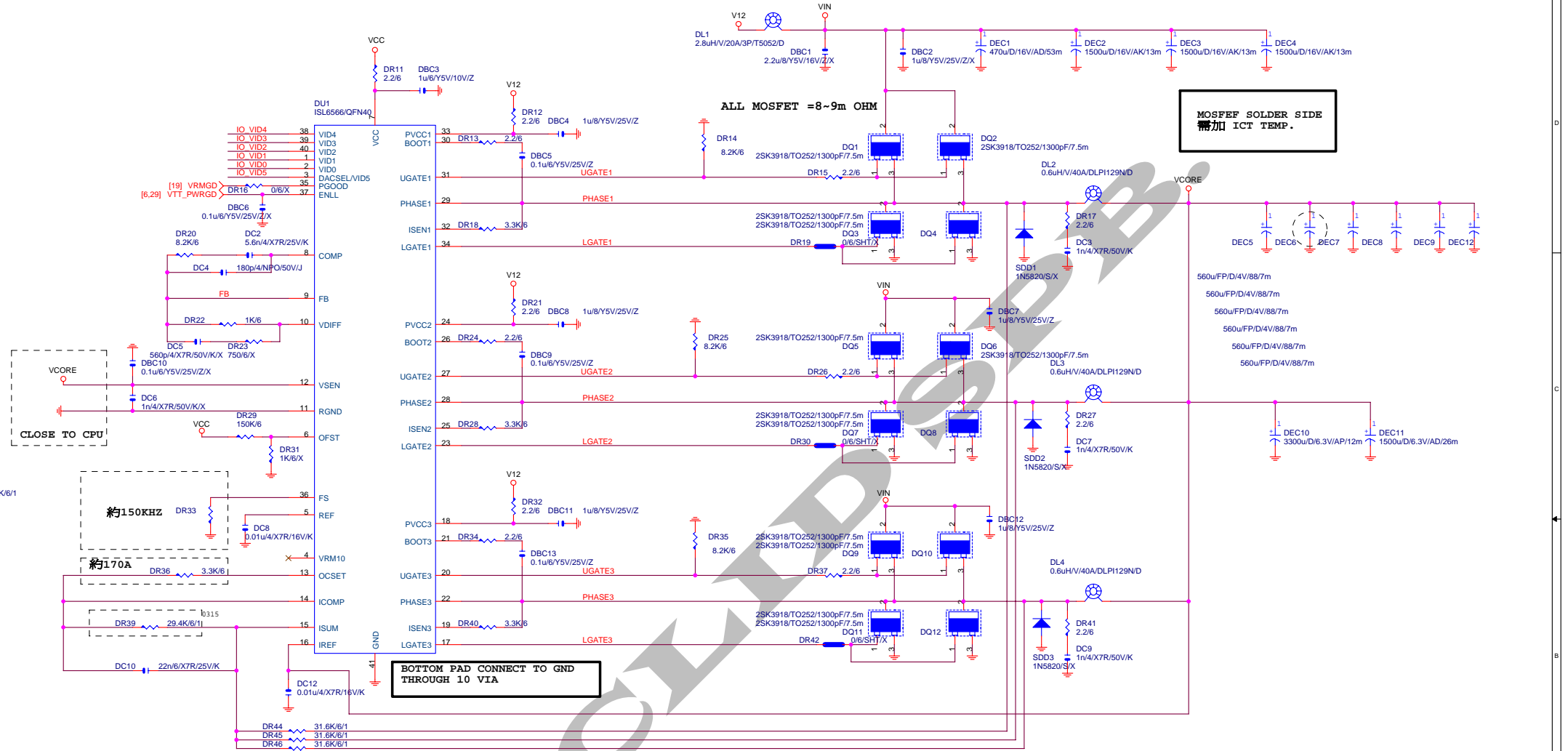

CLOSE TO CPU!

BOTTOM PAD CONNECT TO GND THROUGH 10 VIA

MOSFET SOLDER SIDE  
需加 ICT TEMP.

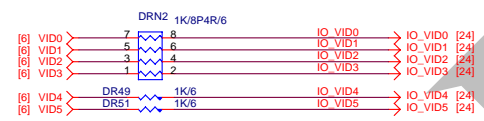

<b>Gigabyte Technology</b>			
Title <b>VRD 10.1/ ISL6556</b>			
Size	Document Number	<b>81945GME</b>	Rev
Custom			<b>1.0</b>
Date:	Monday, October 31, 2005	Sheet	30 of 33

# ATX POWER CONNECTOR

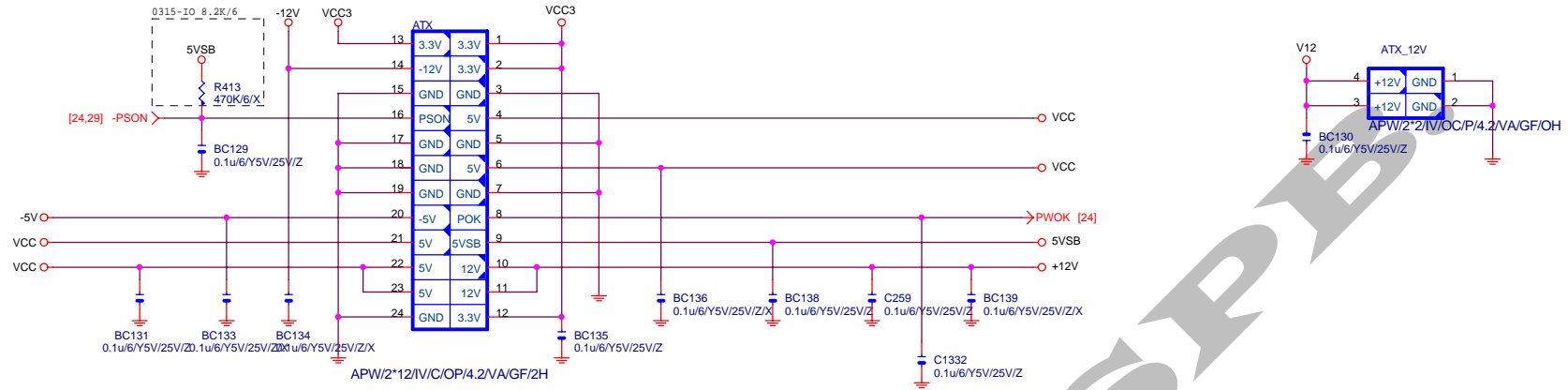

HOLE\_3-2--->有鉛

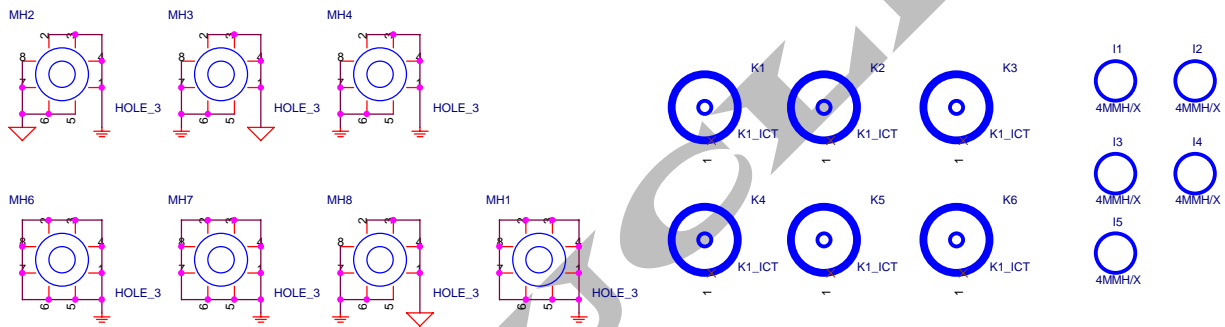

<b>Gigabyte Technology</b>		
Title		
<b>ATX POWER CONNECTOR</b>		
Size	Document Number	Rev
B	<b>81945GME</b>	<b>1.0</b>
Date:	Monday, October 31, 2005	Sheet 31 of 33

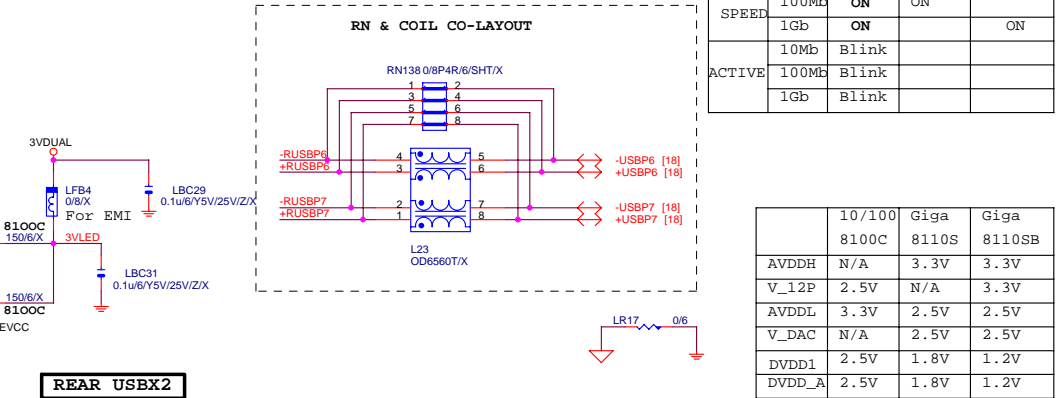
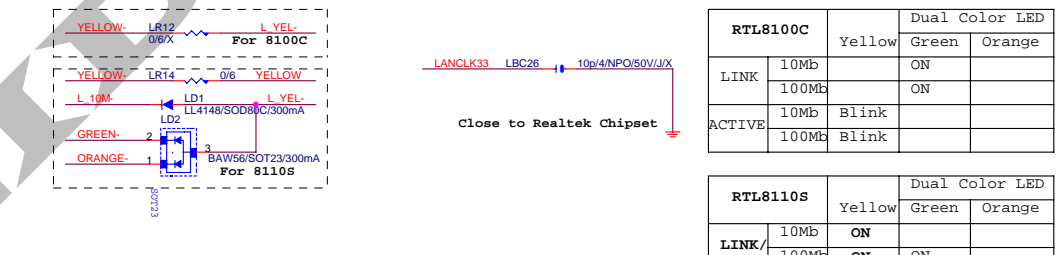
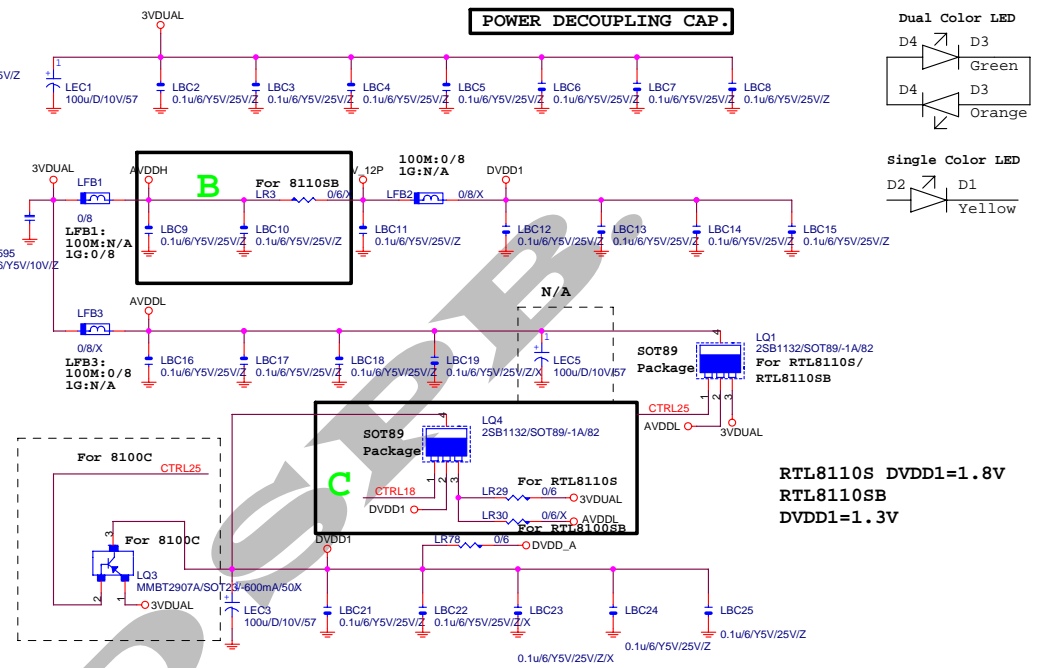
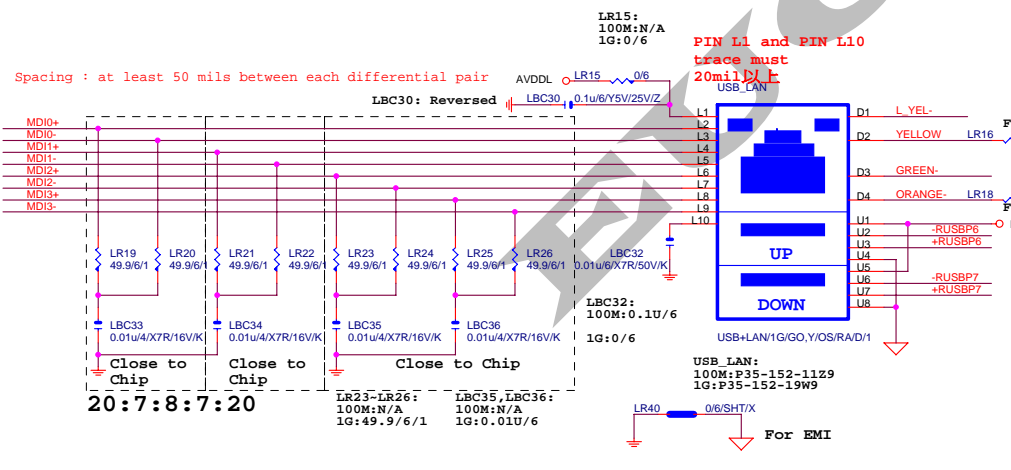
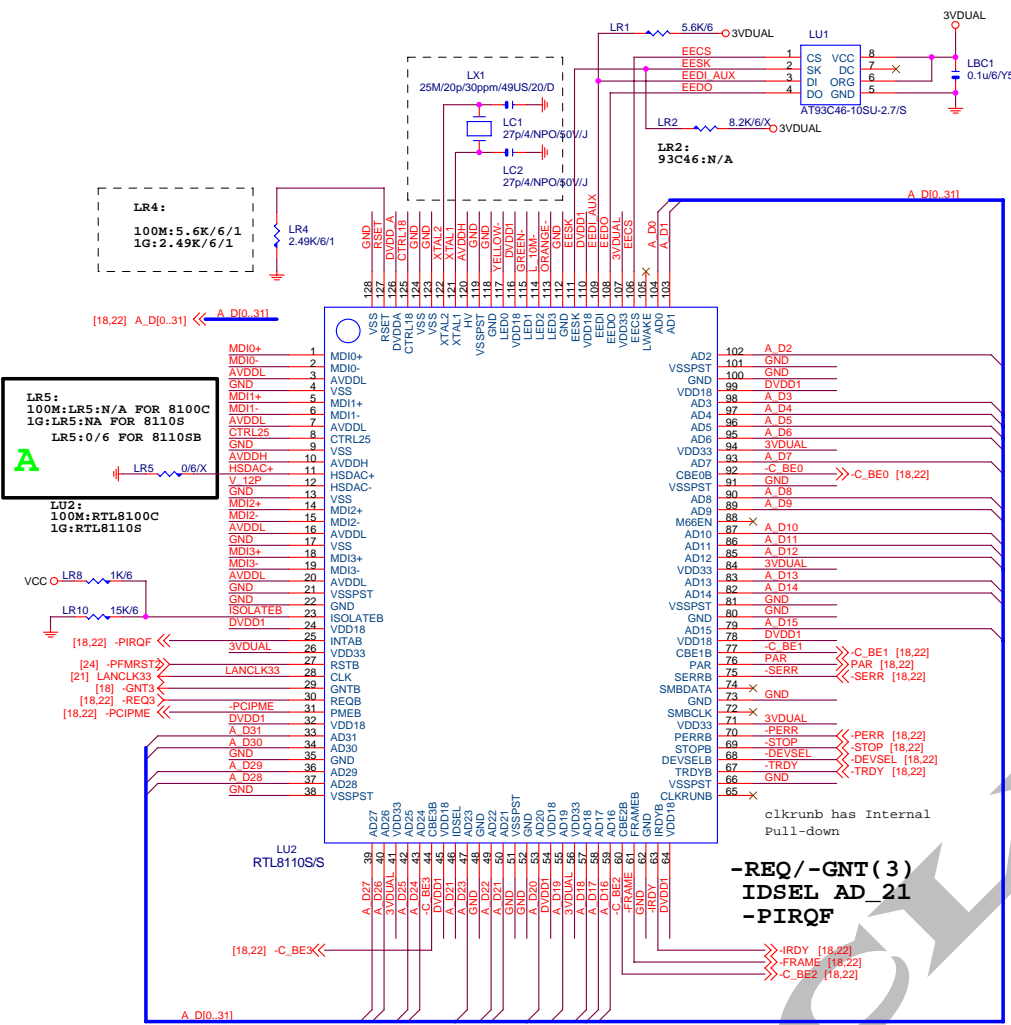

RTL8100C		Dual Color LED		
LINK	Speed	Yellow	Green	Orange
10Mb	100Mb	ON	ON	ON
	10Mb	Blink	Blink	Blink
ACTIVE	100Mb	Blink	Blink	Blink
	100Mb	Blink	Blink	Blink

RTL8110S		Dual Color LED		
LINK/SPEED	Speed	Yellow	Green	Orange
10Mb	100Mb	ON	ON	ON
	10Mb	ON	ON	ON
ACTIVE	100Mb	Blink	Blink	Blink
	100Mb	Blink	Blink	Blink

	10/100	Giga	Giga
	8100C	8110S	8110SB
AVDDH	N/A	3.3V	3.3V
V_12P	2.5V	N/A	3.3V
AVDDL	3.3V	2.5V	2.5V
V_DAC	N/A	2.5V	2.5V
DVDD1	2.5V	1.8V	1.2V
DVDD_A	2.5V	1.8V	1.2V



**CPU SMART FAN SMART FAN**

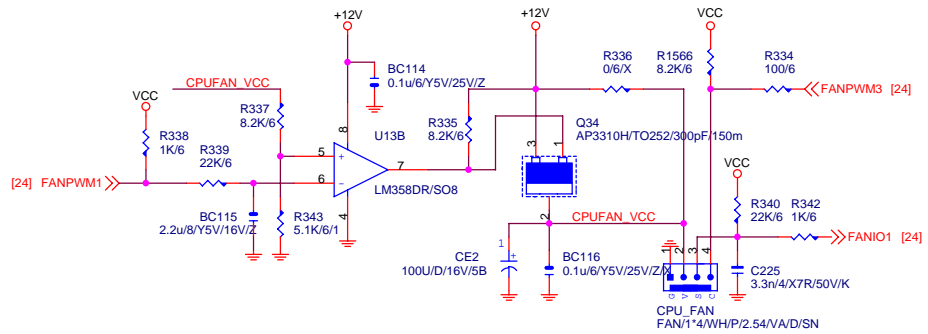

**PROCESSOR HOT**

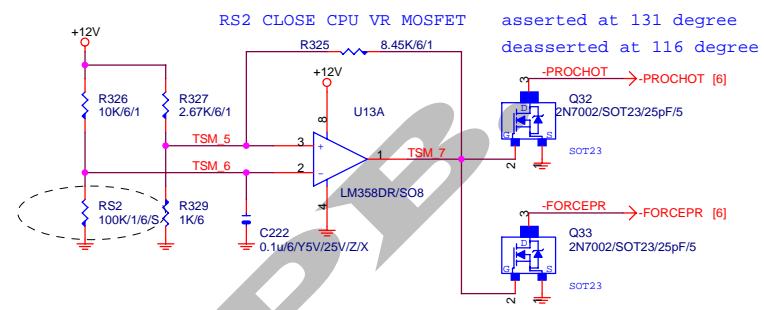

**INTEL FRONT PANEL**

MPD- : (GPIO25--VCCSUS3+HI+HI+DEFINED(C3/C4/S/1/S3/S/4/S5)) -->INTEL

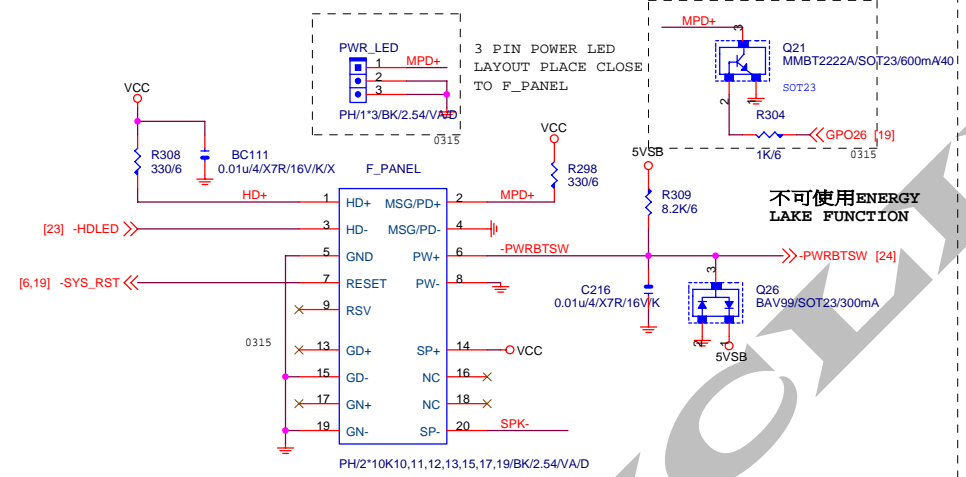

**SYS\_FAN**

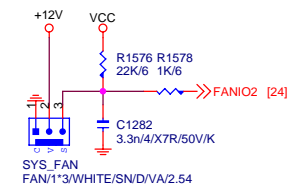

**BUZZER**

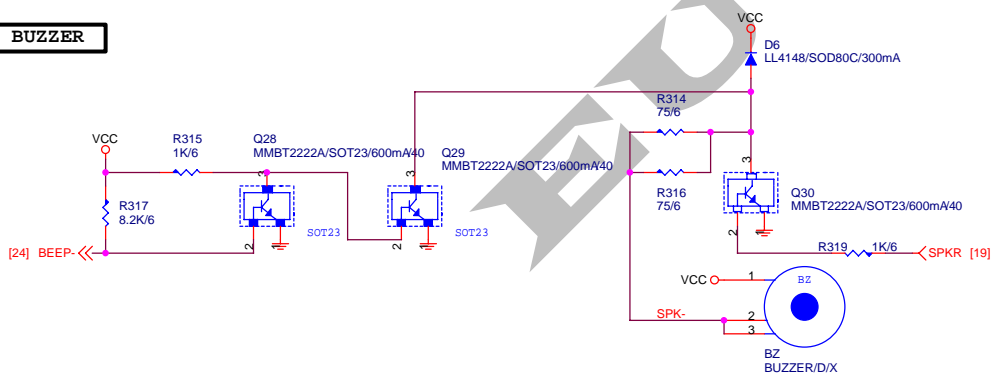

<b>Gigabyte Technology</b>			
Title			
<b>FRONT PANEL</b>			
<b>8I945GME</b>			
Size	Document Number	Rev	1.0
Custom			
Date:	Monday, October 31, 2005	Sheet	33 of 33